

Title	STUDIES ON THE ELECTRONIC STRUCTURE AND THE DYNAMIC BEHAVIORS OF THE ELECTRON DONOR-ACCEPTOR COMPLEX IN ITS LOWEST EXCITED SINGLET STATE
Author(s)	Masuhara, Hiroshi
Citation	大阪大学, 1971, 博士論文
Version Type	VoR
URL	https://hdl.handle.net/11094/1592
rights	
Note	

Osaka University Knowledge Archive : OUKA

<https://ir.library.osaka-u.ac.jp/>

Osaka University

STUDIES ON THE ELECTRONIC STRUCTURE AND
THE DYNAMIC BEHAVIORS OF THE ELECTRON DONOR-ACCEPTOR COMPLEX
IN ITS LOWEST EXCITED SINGLET STATE

A Thesis

Submitted to the Graduate School Osaka University
for the Degree of Doctor of Engineering
in Division for Research of Engineering Science

by Hiroshi Masuhara.

B.S., Tohoku University, 1966

M.S., Tohoku University, 1968

71CL07062

図書館

2

CONTENTS

CHAPTER I

INTRODUCTION	- 1
--------------	-----

CHAPTER II

THE ELECTRONIC STRUCTURE OF THE ELECTRON DONOR-ACCEPTOR COMPLEX IN ITS LOWEST EXCITED SINGLET STATE	- 5
2-1 Experimental	- 7
2-2 Results	- 10
2-3 Discussion	- 16
2-4 Summary	- 28

CHAPTER III

THE IONIC DISSOCIATION OF THE ELECTRON DONOR-ACCEPTOR COMPLEX IN ITS LOWEST EXCITED SINGLET STATE	- 41
3-1 Experimental	- 44
3-2 Results	- 46
3-3 Discussion	- 49
3-4 Summary	- 56

CHAPTER IV

INTERACTIONS BETWEEN EXCIPLEXES AND BETWEEN EXCITED ELECTRON DONOR-ACCEPTOR COMPLEXES IN SOLUTION	- 67
--	------

REFERENCES	- 76
------------	------

ACKNOWLEDGEMENTS	- 83
------------------	------

CHAPTER I

INTRODUCTION

The chemistry of the unstable intermediates in the photochemical reaction has been studied mostly by the flash photolysis method, which was developed by Norrish and Porter.¹ The electronic absorption spectra of excited molecules and of photoproduced unstable species have been obtained, and also rise and decay curves of these spectra have been followed by this method. From these results the electronic structures of intermediates have been studied and the mechanism of photochemical reactions has been made clear.² Since the time resolution of the flash photolysis method is few microseconds, no problems on the short-lived species such as molecules in the excited singlet states and in $n-\pi^*$ triplet states had been solved by an absorption spectroscopy. However, this limitation has been removed by the application of a giant pulse laser. The studies on electronic structure and dynamic behaviors of short-lived species, whose lifetimes are in nsec region, have become important and fruitful problems.

The first observation of the excited singlet-singlet (S_1-S_n) absorption spectra were given by Novak and Windsor.³ They observed the S_1-S_n spectra of coronene, 1,12-benzperylene, 1,2-benzanthracene and 1,2,3,4-dibenzanthracene, using an image-converter camera as the detector. The S_1-S_n absorption spectra of phthalocyanine and cryptocyanine,⁴ pyrene,^{5,6} naphthalene,^{7,8} anthracene⁹ and benzene¹⁰ were measured successively. The new absorption spectra of triphenylene, 3,4-benzpyrene, phenanthrene, 3,4-benzphenanthrene, 3,4,9,10-dibenzpyrene and 1,2,5,6-dibenzanth-

racene in their lowest excited singlet state and the confirmation on the S_1-S_n bands of coronene and pyrene were given by Porter and Topp.¹¹ Referring to the above observed S_1-S_n absorption spectra, the consideration on the electronic structures of the lowest excited singlet state and the higher excited singlet state will be given in the future.

The direct observation on the dynamic behaviors of the excited molecules in nsec region was firstly given by Porter and Topp.¹¹ They investigated upon the intersystem crossing, energy transfer as well as the effect of oxygen. The fast formation of the hydrated electron was also observed directly by using a N_2 -laser as an exciting light source.¹² At the present stage of nsec flash photolysis, the studies on the photochemical primary processes and the dynamic behaviors of the excited molecules are few.¹³ However, these problems will be investigated extensively upon and solved shortly.

The excited electron donor-acceptor (EDA) complexes and exciplexes, upon which we have investigated mainly with fluorescence measurements, are very sensitive to the surrounding solvents. The effect of charge-transfer on the interactions between the complex and the surroundings and on the steric configuration must be involved in the consideration on the excited electronic states. Then, the direct observation of the excited complexes in nsec region is indispensable to study the electronic structures and the dynamic behaviors of the EDA complexes and exciplexes in their lowest

excited singlet states. Until now the S_1-S_n absorption spectra are observed in cases of benzene and pyrene excimers,^{14,15} anthracene-N,N-diethylaniline heteroexcimer¹⁶ and the EDA complexes of s-tetracyanobenzene (TCNB) and pyromellitic dianhydride with methyl-substituted benzenes.^{17,18} The observed S_1-S_n absorption spectra of the above EDA complexes and exciplex are found to be similar to those of electron-acceptor anion. However the observed spectra are few, and the electronic structures and the dynamic behaviors of the excited EDA complexes and exciplexes are left unknown.

In the present thesis, the S_1-S_n absorption spectra of TCNB complexes with methyl-substituted benzene^Y in nonpolar solvents will be reported and the theoretical study on the excited EDA complexes, which is applicable to the observed experimental results, will be given in Chapter II. TCNB complexes in their lowest excited singlet states are very sensitive to the solvents and dissociate into ion radicals in polar solvents. This investigation upon the ionic dissociations of the EDA complexes in their lowest excited singlet states, solvent effect on the dissociation and the influence of the donors to these dynamic behaviors will be reported and discussed^S in Chapter III. A particular and interesting behavior of the excited EDA complexes and exciplexes is the interaction between themselves. These interactions will be given in Chapter IV.

CHAPTER II

THE ELECTRONIC STRUCTURE OF THE ELECTRON DONOR-ACCEPTOR
COMPLEX IN ITS LOWEST EXCITED SINGLET STATE

The properties and behaviors of weak EDA complexes in the ground state have been studied in detail, while the investigations of the excited EDA complexes are rather scarce and performed mainly with fluorescence and phosphorescence measurements. An exceptional example studied in detail is the EDA complex of TCNB with substituted benzene.^{1,2,3} The study on the excited singlet state of the TCNB complex was given by Mataga and Murata.¹ They have measured the effect of temperature and solvent polarity on the wave numbers of fluorescence spectra, relative fluorescence quantum yield and fluorescence decay times of the complexes. From the results of their investigations, it was concluded that there arised a considerable differences of the energies as well as the structures between the excited FC state and the excited equilibrium state and that the electronic structure of the fluorescent state was quite polar.

The study on the excited states of the weak EDA complexes has a close connection with that on the heteroexcimer (HE). HE is a kind of the EDA complexes, which is stable in the excited state while dissociative in the ground state, and consists of different component molecules.⁴ Since HE has a polar structure and probably resembles to the excited singlet state of weak EDA complexes, the EDA interaction of the latter was closely studied in relation to that of HE.^{1,5} On the other hand, the connection among the EDA interaction and the electron transfer processes has been examined.⁶ It is well known that the ionic dissociation of HE or the production of ion radicals by the encounter collision in the excited

state occur rather easily in polar solvents.^{4,5,6} However, whether the weak EDA complex in the excited singlet states, which resembles to HE, dissociates or not has not been examined. Recently, we have shown that the ionic dissociation of TCNB-toluene complex in the lowest excited singlet state occurs in acetonitrile.⁷ Since the dissociation of pyromellitic dihydride-mesitylene complex in the triplet state into ions has been reported by Potashnik et. al.,⁸ it has been confirmed that one complex dissociates in the CT singlet state and other in the CT triplet state. Thus, the study on the electronic structure and the EDA interaction of the excited weak EDA complex and of HE in relation to the stability, geometrical configuration transformation (from the FC state to the equilibrium state) and dissociation processes seems to be important and fruitful.

We have first observed the S_1-S_n absorption spectra of TCNB complexes by means of the giant pulse laser photolysis, which is a direct information on the electronic structure of the excited singlet state of the complex. In the present paper, the S_1-S_n absorption spectra and the results of the theoretical calculations made by considering the CI among the ground, CT, back CT and locally excited configurations of TCNB anion and donor cation, will be given.

2-1 Experimental

We have used a Q-switched ruby laser (Japan Electron Optics, JLR-02A) with the out-put power of ca. 1.5 joule. The exciting

light pulse of 347 nm produced through the ADP frequency doubler with conversion efficiency of 8%. The light pulse has a duration of 15-20 nsec. The S_1-S_n absorption spectra were measured photographically by using the laser-breakdown sparks produced in O_2 and Xe gases as spectro-flashes. Since the sparks produced in O_2 and Xe have durations of several tens nsec and about 1 μ sec, respectively, the former spark is exclusively used to observe the short-lived transient S_1-S_n absorption spectra.

The technical problems on the laser photolysis have been explained in detail by Novak and Windsor, and Porter and Topp.⁹ In the present paper, only the point we have attended to will be mentioned. Since the optical alignment of the laser photolysis apparatus is very critical, the burned positions of the coloured paper produced with the 694 nm and 347 nm pulses were recorded and the optical passes of both pulses were reproduced by a He-Ne gas laser. The cell holder and lenses are fixed on the micrometers to make fine alignment possible. The magnet bases holding micrometers and prisms are mounted on a heavy steel rail to avoid a warp. Whether the optical matching of the ADP crystal is attained or not, is also important in the alignment, because the crude matching of the frequency doubler produces a slight shift of the irradiation position on the sample to be measured, being placed at a distance of 1m from the separating prism. The optical arrangement is shown in Fig. 1.

The constructed laser photolysis apparatus was checked by measuring the triplet-triplet absorption of anthracene solution,

which has a large value of extinction coefficient. The oscillograms of the relevant measurement are shown in Fig. 2.

Fluorescence spectra and fluorescence decay curves at several wavelengths were observed at the opposite side to the laser excitation, since the re-absorption of fluorescence was mainly examined. The ordinary fluorescence measurement was made with an Aminco-Bowman spectrophotofluorometer.

The photomultiplier used for the optical detection was RCA 1P28 equipped with 50 Ω resistor and the time constant of the electronic circuits was a few nsec. The photographical observation and photoelectric measurements at several wavelengths were performed using Malumi R21 spectrograph. The Tektronix 585A synchroscope was triggered by a signal from Hewlett-Packard 5082-4220 photodiode which received the scattered laser pulse. The rapid kinetic analysis in nsec time region was made by using Fuji x-ray and Kodak 2475 recording films. Fuji S3 and S33~~X~~ films were used to take the photograph. The saturated CuSO₄ solution and Toshiba UV-39 filter were arranged suitably to remove the scattered pulse.

TCNB was the same sample as used before.¹ Benzene and toluene (Merck, Spectrograde) was used without further purification. All other solvents and reagents were purified according to the same method as described elsewhere.¹ All the solutions measured were degassed completely by means of freeze-pump-thaw method.

2-2 Results

The S_1-S_n Absorption Spectra of TCNB-Toluene Complex by Laser Photolyses.

A toluene solution of TCNB (O.D.~1.0 at 347 nm, which corresponds to the tail of CT band) was irradiated with a 347 nm pulse. The transient spectra photographed by a breakdown spark of O_2 are shown in Fig.3. Since the CT fluorescence of TCNB-toluene system is not so weak as being neglected compared to the O_2 spark and is far stronger than the usual Xe lamp, it is rather difficult to observe S_1-S_n absorption spectra. The spectra in Fig. 3 have been corrected by calibrating the film blackening due to the fluorescence. Since this spectra are obtained only with the O_2 spark but not with the Xe spark, it is suggested that the spectra are due to the short-lived species, i. e., the excited state of TCNB-toluene system. The observed absorption spectra are similar to those of the TCNB anion,¹⁰ but the behavior of this transient species is different from that of TCNB anion, which is produced by dissociation from the excited state of TCNB-toluene complex in polar solvents such as acetonitrile. In the former case, the laser-induced photocurrent was not observable, while in the latter case, the photocurrent was detected.¹¹ The TCNB anion produced by exciting the TCNB-toluene-acetonitrile system are detected in a few nsec after the exciting pulse and this anion decays in the course of several ten μ seconds and the decay process can be photographed also with Xe spark. The TCNB anion can be produced more densely than the present short-live

transient species and can be observed under rather low excitation density. Some part of the anions are quite stable and observable even by the usual spectrophotometer. Because of the very short lifetime and no laser-induced photocurrent, the absorption spectra shown in Fig. 3 can be assigned to the S_1-S_n absorption spectra of TCNB-toluene complex. This assignment is confirmed by the interesting observation of CT fluorescence by laser excitation, which is described in the following section. Moreover, no absorption band which is similar to toluene cation in the case of TCNB-toluene system or no absorption band of toluene cation in the case of TCNB-toluene-acetonitrile has been found.

Fluorescence and S_1-S_n Absorption Spectra of TCNB Complex by Laser Excitation.

Since, in the case of laser excitation, the population of the excited EDA complex is much larger than that in the case of the ordinary spectrophotometric measurements, there arises rather strong re-absorption of the CT fluorescence by the excited complex itself. Then, the S_1-S_n absorption spectra have been obtained by comparing the fluorescence spectra obtained by the laser excitation with those observed by Aminco-Bowman spectrophotofluorometer. Since the CT fluorescence spectra in the present work are rather broad and have no structure, the fluorescent light can work as a good light source for the absorption spectral measurements.¹²

Concerning the fluorescence decay characteristics at various

wavelengths, the following features should be noted; (1) At longer wavelengths than 485 nm, the decay curves are exponential and have decay times of about 110 nsec. (2) At about 470 nm, the decay curve is not exponential but has a peculiar shape. Though we cannot determine exact decay times from this curve, the apparent decay time seems to be rather long (160 nsec). (3) At about 430 nm, the decay curve is rather close to exponential, while the peculiar shape of the curve as observed at ca. 470 nm can still be observed. Two typical decay curves are indicated in Fig. 4.

The time-resolved fluorescence spectra obtained by plotting the fluorescence intensities at various stage of decay, are shown in Fig. 5. At an earlier stage of decay (0-50 nsec), a characteristic hollow at about 470 nm are observed, but it disappears at about 100 nsec. Moreover, the fluorescence spectra at later stage of decay are identical with those observed by an Aminco-Bowman spectrofluorometer.

The characteristic hollow in the spectra and the deviation from the exponential decay observed at ca. 470 nm, can be ascribed to the re-absorption of the fluorescence by the high density excited singlet state produced by the laser excitation. We have carried out a quantitative estimation of the re-absorption effect as follows.¹³

The distribution of the re-absorbing excited EDA complex is, of course, the same as that of the fluorescent EDA complex. Then, the extinction coefficient of the re-absorption at (the wavelength at

which we are observing the fluorescence) is given as,

$$k_{\lambda}(x) = s\Phi_{\lambda 0} 10^{-k_{\lambda}x} \quad (1)$$

where $\Phi_{\lambda 0}$ is the intensity of 347 nm pulse which is exciting exclusively at the CT band of the complex; s is a proportionality constant; x is the distance from the front face of the cell in cm; k_{λ} is the extinction coefficient of the CT band at 347 nm and is ca. 1.0 in this work.

Since the differential fluorescence I_x , which is emitted in the thin layer $x \sim x+dx$, is re-absorbed in the thin layer $y \sim y+dy$, the following equation is derived.

$$dI_x = -\mu(y)I_x dy \quad (2)$$

where y is the distance from x to the back face of the cell in cm and $\mu(y)$ is an absorption coefficient at y . The dependence of μ on y is the difference between the present and usual treatments. In the present case it can easily be derived that

$$\mu(y) = k_{\lambda}(x+y) = s\Phi_{\lambda 0} 10^{-k_{\lambda}x} 10^{-k_{\lambda}y} \quad (3)$$

Putting eq. (3) into eq. (2) and integrating eq. (2) with respect to y , the differential fluorescence I_x observed at the back face of the cell is given as follows.

$$I_x(y=a-x) = 10^{-k_{\lambda}x} \log Q \frac{s\Phi_{\lambda 0} (10^{-k_{\lambda}a} - 10^{-k_{\lambda}x})}{10} / k_{\lambda} \quad (4)$$

where Q is the constant and given as

$$Q = \rho \Omega \Phi_{\lambda 0} F_{\lambda}(\lambda) k_{\lambda} / 4\pi n^2$$

Since we observe the total of the differential fluorescence, I_x must be integrated with respect to x from Q to a . Thus the

fluorescence intensity at λ' in the opposite side to the excitation is given as follows.

$$d\bar{\Phi}'(\lambda')d\lambda' = \int_0^a I_x dx d\lambda' = \rho \Omega F_\lambda(\lambda') k_\lambda (1 - 10^{-k_\lambda a} s \bar{\Psi}_{\lambda_0} (10^{-k_\lambda a} - 1)/k_\lambda) d\lambda' / 4\pi n^2 s \quad (5)$$

For the notation in these equation, we refer to Förster's treatment.¹⁴

In the present case, the excitation intensity $\bar{\Psi}_{\lambda_0}$ is ca. 10^{16} photons, k_λ is adjusted to be 1.0, a is 1 cm, and s is calculated to be 1.6×10^{-16} , assuming the re-absorption coefficient of the S_1-S_n band to be 10^4 . The re-absorption of several tens % of the fluorescence at ca. 470 nm is expected from the estimation by eq. (5) with these values. When the excitation intensity $\bar{\Psi}_{\lambda_0}$ is weak, eq. (5) is reduced to the usual eq. (6).¹⁴

$$d\bar{\Phi}'(\lambda')d\lambda' = \rho \Omega \bar{\Psi}_{\lambda_0} F_\lambda(\lambda') (1 - 10^{-k_\lambda a}) d\lambda' / 4\pi n^2 s \quad (6)$$

Since the re-absorption extinction coefficient as well as fluorescence follow the exponential decay, it can easily be derived that

$$d\bar{\Phi}'(\lambda', t)d\lambda' = \rho \Omega F_{\lambda_0}(\lambda') k_\lambda (1 - 10^{-k_\lambda a} s_0 \bar{\Psi}_{\lambda_0} e^{-t/\tau} (10^{-k_\lambda a} - 1)/k_\lambda) d\lambda' / 4\pi n^2 s_0 \quad (7)$$

where τ is the fluorescence lifetime, and F_{λ_0} and s_0 satisfy the following equations, respectively.

$$\begin{aligned} F_\lambda &= F_{\lambda_0} e^{-t/\tau} \\ s &= s_0 e^{-t/\tau} \end{aligned} \quad (8)$$

The simulated curves obtained by means of eq. (7), using value obtained from the exponential decay of the fluorescence are given in Fig. 4. One can see a good agreement between experimental and

simulated curves.

Thus, it is evident that the characteristic hollow in the fluorescence spectra and the non-exponential decay at about 470 nm are due to the re-absorption of the fluorescence by the excited singlet state of the EDA complex. Then, we can obtain the S_1-S_n absorption spectra of the complex by comparing the fluorescence spectra observed by an Aminco-Bowman spectrophotofluorometer and those observed by laser excitation. The results in the cases of TCNB-toluene and TCNB-benzene complexes are given in Fig. 6 and Fig. 7, respectively. These are the first observation of the S_1-S_n absorption spectra of EDA complex which is stable in the ground state. The spectra of the TCNB toluene system are identical with those observed by laser photolysis.

2-3 Discussions

In general, the electronic structures of the excited states are usually discussed with the SCF molecular orbitals of the ground state, assuming that the geometry of the excited state are the same as that of the ground state. However, in the case of EDA complexes, the effect of CT on the interactions with solvents and on the steric configuration must be involved in the consideration on the excited electronic states. Untill now the electronic structures of the excited states of weak EDA complexes have been investigated mainly with fluorescence measurements. It has been shown that the Stokes shifts of the fluorescence spectra of TCNB and pyromellitic dianhydride (PMDA) complexes are anomalously large.^{1,15,16,17,18} It is also confirmed that the observed fluorescence lifetimes of TCNB-toluene and TCNB-benzene complexes at room temperature are much longer than the radiative lifetimes calculated from the intensity of the absorption band at room temperature.^{1,18} These experimental results have lead to the conclusion that the considerable change of the electronic structures of the complex occurs during the fluorescence lifetime at room temperature where the molecular rearrangement motions including the surrounding solvent molecules can easily occur.

Now, direct observation of the electronic structure of the weak EDA complex in the excited state are made possible by laser excitation. The above mentioned S_1 - S_n absorption spectra of TCNB-toluene and TCNB-benzene complexes are quite similar to the absorp-

tion spectra of TCNB anion. Recently, the S_1-S_n absorption band of these complexes observed by N_2 -laser excitation have been reported,¹⁹ and they are in a good agreement with our present results. In the case of PMDA-(mesitylene) complex, the absorption spectra in the lowest excited singlet state are similar to those of PMDA anion.¹⁹ Moreover, the S_1-S_n absorption spectra of anthracene-N,N-dimethylaniline HE is also reported,²⁰ and its spectra are similar to those of anthracene anion. These circumstances seem to be common to all the complexes which have weak or no EDA interaction in the ground state. Thus, it has been directly confirmed that the electronic structures of these complexes in the lowest excited singlet states are quite polar and seem to be "contact ion-pair."

Until now, there has been no theoretical study on the EDA complexes which is applicable to the above experimental results on the excited EDA complexes. According to the detailed study made on the ground state complex by Iwata et. al.,²¹ the local excited and CT configurations contribute equally to the lowest excited singlet state in the case of TCNB-toluene complex. Although this excited state, of course, corresponds to the excited FC state and not to the fluorescent state, this theoretical expectation differs from the experimental results. Then, the theoretical considerations based on the wavefunctions in the ground state appear to be invalid in the study of the excited EDA complex and some different theoretical method for the excited weak EDA complex must be proposed. We have made a theoretical consideration on the excited electronic

structure of the weak EDA complex in solution, based on the re-arrangement process in the solute-solvent interactions and also based on the interaction between the donor cation and acceptor anion.

Theoretical

Our theoretical calculation consists of the configuration interaction (CI) among ground, CT (pure ion-pair, no bond between the ions), locally excited and back CT configurations. The wave functions of these configurations are given as follows, referring to Iwata et. al.²¹ and Masuhara et. al.,²² concerning the notations and numberings of the molecular orbital's (MO's).

$$\begin{aligned} \bar{\Psi}_G &= |\theta_1 \bar{\theta}_1 \theta_2 \bar{\theta}_2 \theta_3 \bar{\theta}_3 \varphi_1 \bar{\varphi}_1 \dots \varphi_7 \bar{\varphi}_7| & G \\ \bar{\Psi}_{CT} &= \frac{1}{\sqrt{2}} (|\theta_1 \bar{\theta}_1 \theta_2 \bar{\theta}_2 \theta_3 \bar{\theta}_3 \varphi_8 \bar{\varphi}_8 \dots \varphi_7 \bar{\varphi}_7| - |\theta_1 \bar{\theta}_1 \theta_2 \bar{\theta}_2 \theta_3 \bar{\theta}_3 \varphi_8 \bar{\varphi}_8 \dots \varphi_7 \bar{\varphi}_7|) & SCT \\ \bar{\Psi}_{A(7 \rightarrow 8)} &= \frac{1}{\sqrt{2}} (|\theta_1 \bar{\theta}_1 \theta_2 \bar{\theta}_2 \theta_3 \bar{\theta}_3 \varphi_7 \bar{\varphi}_7 \dots \varphi_8 \bar{\varphi}_8 \varphi_8 \bar{\varphi}_8| - |\theta_1 \bar{\theta}_1 \theta_2 \bar{\theta}_2 \theta_3 \bar{\theta}_3 \varphi_7 \bar{\varphi}_7 \dots \varphi_8 \bar{\varphi}_8 \varphi_8 \bar{\varphi}_8|) & A(7 \rightarrow 8) \\ \bar{\Psi}_{B(8 \rightarrow 10)} &= \frac{1}{\sqrt{2}} (|\theta_1 \bar{\theta}_1 \theta_2 \bar{\theta}_2 \theta_3 \bar{\theta}_3 \varphi_8 \bar{\varphi}_8 \dots \varphi_7 \bar{\varphi}_7| - |\theta_1 \bar{\theta}_1 \theta_2 \bar{\theta}_2 \theta_3 \bar{\theta}_3 \varphi_8 \bar{\varphi}_8 \dots \varphi_7 \bar{\varphi}_7|) & B(8 \rightarrow 10) \\ \bar{\Psi}_{A'(1 \rightarrow 3)} &= \frac{1}{\sqrt{2}} (|\theta_1 \bar{\varphi}_8 \theta_2 \bar{\theta}_2 \theta_3 \bar{\theta}_3 \varphi_1 \bar{\varphi}_1 \dots \varphi_7 \bar{\varphi}_7| - |\theta_1 \bar{\varphi}_8 \theta_2 \bar{\theta}_2 \theta_3 \bar{\theta}_3 \varphi_1 \bar{\varphi}_1 \dots \varphi_7 \bar{\varphi}_7|) & A'(1 \rightarrow 3) \\ \bar{\Psi}_{BCT(8 \rightarrow 4)} &= \frac{1}{\sqrt{2}} (|\theta_1 \bar{\theta}_1 \theta_2 \bar{\theta}_2 \theta_3 \bar{\theta}_3 \varphi_4 \bar{\varphi}_4 \dots \varphi_7 \bar{\varphi}_7| - |\theta_1 \bar{\theta}_1 \theta_2 \bar{\theta}_2 \theta_3 \bar{\theta}_3 \varphi_4 \bar{\varphi}_4 \dots \varphi_7 \bar{\varphi}_7|) & BCT(8 \rightarrow 4) \end{aligned}$$

where notations on the right hand side are abbreviations for the configurations. G, SCT, A and B, A', and BCT represent ground configuration, CT configuration, locally excited configurations (of TCNB anion), locally excited configurations (of donor cation), and back CT configuration, respectively. The energies of each configuration were evaluated by taking the energy of SCT as the standard.

The local excitation energies of TCNB anion and donor cation were taken from the observed values of Ishitani and Nagakura,²³

and Shida and Hamill²⁴, respectively. Open shell-SCF calculations were performed to determine the correspondence between the locally excited configurations and the observed transition energies of ion radicals. The results are shown in Table 1 and 2.

Table 1. The Absorption Spectra of TCNB Anion.

$E_{\text{obs.}}^{23}$	$E(\text{SCF CI})^{23}$		$E(\text{SCF})$	
2.684 eV	1.941 eV	x ^(a)	2.042 eV	B(8→10)
3.306	3.379	y	3.495	B(8→11)
3.492				
4.444	4.413	y	3.806	A(7→8)
4.779	4.592	x	4.386	A(6→8)

(a) x and y represent the transitions polarized along the long and short axes, respectively.

Table 2. The Absorption Spectra of Toluene Cation.

E_{obs}^{24}		$E(\text{SCF})$	
1.070	x	0.429	A'(2→3)
2.694	y	3.409	A'(1→3)

The details of open shell SCF calculation were the same as those reported by Masuhara et. al.²² In the case of toluene cation, the valence state ionization potential of the ring carbon atom which is connected with methyl group, was intentionally lowered a little to treat MO's in C_{2v} symmetry. It is difficult to estimate the transition energy of back CT, because orbital energies of open shell SCF MO cannot be regarded as representing the ionization

potential and electron affinity. Although the experimental values of oxidation-reduction potentials in solution are available, they do not give information on higher MO energies. Then, we have evaluated empirically the energy of the back CT configuration by means of the rearrangement energy accompanying the electron transfer process. The details of the procedure will be described later. The energy difference between configurations SCT and G was taken to be the energy of the 0-0 band of the fluorescence.

The non-diagonal terms of CI secular equation were evaluated theoretically by using open shell SCF MO's and STO's for intermolecular electrostatic interactions and for overlap integrals, respectively.²⁵ The point-charge approximation was adopted for the former calculation. Instead of the overlap integrals between the carbon AO's of the donor cation and the nitrogen AO's of TCNB anion those between carbon AO's were used. The differences between C-N and C-C overlap integrals are calculated to be negligible in the present case.²⁶

The bond length of C-C and C-N were assumed to be 1.39 and 1.36 Å, respectively. The C-C≡N angle was taken to be 180° and all other bond angles were assumed to be 120°. The resonance integrals β_{CC} and β_{CN} were taken as -2.39 and -3.28 eV, respectively.²¹ The calculations were made for three geometrical models (i) $R_x=1.20\text{Å}$, $R_y=0.695\text{Å}$, and $R_z=3.40\text{Å}$ (ii) $R_x=1.20\text{Å}$, $R_y=0$ and $R_z=3.40\text{Å}$ (iii) $R_x=R_y=0$ and $R_z=3.4\text{Å}$. In the model (ii), we have examined also the case of much longer value of R_z . R_x , R_y and R_z re-

present the coordinate of the center of one benzene ring, taking the center of the benzene ring as origin of the coordinate.

The Rearrangement Energy and the Back CT Transition

In general, solvent effects on the electronic spectra can be divided into two parts. The first is due to the electronic polarization of the solvent, which can follow the electronic transition of the solute. The second depends on the atomic plus orientation polarization which cannot follow the electronic transition. The stabilization energy of the solute due to the latter polarization during the lifetime of the excited state is called the re-orientation energy. However, things are different, in weak EDA complexes and EDA ion-pairs.²⁷ In the case of TCNB-toluene, the local excitation configuration of TCNB and CT configuration contribute equally to the excited FC state²¹, while the fluorescent state is found to be very polar according to the present laser investigation. Then the relaxation process from the excited FC state to the equilibrium state consists of the change in the electronic structure of the complex as well as the re-orientation stabilization. Of course, the re-orientation energy should contain that part due to the change in the electronic structure which arises in the course of the relaxation. We call the total energy change from the excited FC state to the excited equilibrium state the rearrangement energy ΔE_{rea} . In the case of TCNB-hexamethylbenzene (HMB) complex, the CT configuration is predominant in the excited FC state, and the

overwhelming CT character in the equilibrium state is predicted from the estimation of the transition dipole of fluorescence process.¹⁸ In the case of this complex, the solvent seems to be oriented to some extent already in the ground state as well as in the excited FC state since the contribution of the CT configuration in the ground state of this complex is considerably larger than that of weaker complex such as TCNB-toluene. Then the rearrangement energy in the case of TCNB-HMB complex may be relatively small. The rearrangement energy may be given as $\Delta E_{\text{rea}} = h\nu_a - h\nu_{f,0-0}$, where $h\nu_a$ and $h\nu_{f,0-0}$ represent the energy of the CT absorption band maximum and the 0-0 band of fluorescence, respectively. We have confirmed that ΔE_{rea} decreases as the EDA interaction becomes stronger.

Now, in the back CT, an electron is transferred from the half-occupied MO of TCNB anion to the vacant MO of donor cation. Therefore, there arises a large destabilization energy of rearrangement due to this transition. Quite similar consideration on the change of intermolecular interaction in the excited state of EDA-ion-pair of methyl-pyridinium salts has been given by Briegleb et al.²⁷ This rearrangement energy $\Delta E_{\text{rea}}'$ in the case of back CT is due to the almost complete one electron transfer, while the difference of CT character between the excited FC state and the excited equilibrium state of TCNB-toluene system is about 50%. Then the assumption that $\Delta E_{\text{rea}}' = 2\Delta E_{\text{rea}}$ (TCNB-Toluene) seems appropriate and this value of $\Delta E_{\text{rea}}'$ does not depend on the strength of donor.

As indicated in Fig. 8, the transition energy of back CT can be given as,

$$\begin{aligned}
 E(\text{back CT}) &= E(D^*A) - h\nu_{f.0-0} + \Delta E_{\text{rea}}' \\
 &= E(D^*A) - h\nu_{f.0-0} + 2\Delta E_{\text{rea}}'(\text{TCNB-toluene}) \quad (9)
 \end{aligned}$$

where $E(D^*A)$ represents the energy of locally excited configuration of the donor. The rearrangement energy and the transition energies of back CT estimated by eq. (9) for TCNB complexes with methyl-substituted benzenes are listed in Table 3.

Table 3. The Rearrangement Energies and the Transition Energies of Back CT.

Donor	$h\nu_a^{1,21}$	$h\nu_{f.0-0}$	ΔE_{rea}	$E(D^*A)$	$\Delta E_{\text{rea}}'$	$E(\text{back CT})$
Benzene	4.03eV	3.14eV	0.89eV	4.61eV	1.78(1.84)eV	3.25(3.31)eV
Toluene	3.94	3.02	0.92	4.61	1.84	3.43
Mesitylene	3.51	2.89	0.62	4.55	1.84	3.50
HMB	2.91	2.58	0.33	4.44	1.84	3.70

On the other hand, the energy difference between the ground FC state and the ground equilibrium state of TCNB-toluene system is also due to the rearrangement accompanying one electron transfer from TCNB anion to toluene cation. In this case this stabilization energy in the ground state are given as follows

$$\Delta E_{\text{rea}}' = \Delta E_{\text{des}} = h\nu_{f.0-0} - h\nu_{f.\text{max}} \quad (10)$$

where $h\nu_{f.\text{max}}$ represents energy of the fluorescence maximum.

The theoretical results on the electronic structure of the

excited TCNB complexes will be given by using the value of back CT estimated by the former consideration. The effect of the transition energies of the back CT on the CI calculation will be discussed later.

A Theoretical Consideration on the Electronic Structures of TCNB Complexes.

The S_1-S_n transition energies of TCNB-toluene complex were calculated by invoking the CI. Because of the similarity of the S_1-S_n absorption spectra to those of TCNB anion, the interaction between configurations B(8-10) and $A'(1-3)$, which have about equal transition energies in the observed region, seems to be crucial for the interpretation of the spectra. The non-diagonal terms of $A'(1-3)$ with B(8-10) and SCT were calculated to be rather small, and affect only slightly the results of the CI calculation. Calculated results on TCNB-toluene complex ^{are} shown in Fig. 9, comparing the different geometrical models (i), (ii) and (iii). In the case of model (i), B(8-10) and degenerate back CT configurations are mixed each other completely, and the discrepancy between the observed and calculated energies of S_1-S_n band is large. Then, the similarity of the S_1-S_n band to the absorption of TCNB anion cannot be interpreted on the basis of this model. In the case of model (ii), B(8-10) is lifted up because of considerable interaction with SCT. This interaction is due to the intermolecular electrostatic interaction between several MO's of toluene cation and of

TCNB anion. In this case too, the difference between the observed energy of the S_1-S_n band and the calculated value originating from B(8-10) is rather large. The contribution of B(8-10) to the S_n state is ca. 60%. A better agreement between the observed and calculated energy of S_1-S_n transition may be expected if we take a little larger values of R_z . In the case of model (iii), the symmetry group of the complex is C_{2v} and configurations B(8-10) and SCT belong to different irreducible representations respectively. Furthermore, the off-diagonal terms between these configurations and the other configurations are rather small. Then, B(8-10) will be affected only slightly by the CI calculation and the calculated S_1-S_n absorption spectra will be quite similar to those of TCNB anion. Thus, the similarity of the absorption spectra of the S_1-S_n transition to those of TCNB anion can be explained by taking model (iii) or by assuming (ii) with large R_z values.

In the case of model (ii), rather large value of R_z ($\sim 5.0\text{\AA}$) required to explain the S_1-S_n absorption spectra. However, at such a long distance the intermolecular interaction may be screened to some extent by the intervening solvents. Then, it is appropriate to assume intermediate geometry between (ii) with a longer intermolecular distance and (iii) to be taken in the fluorescent state. Since it has been shown that the TCNB complexes in the ground state are stable in the case of model (i) and (ii)²¹, considerable differences of the geometrical configurations and of the electronic structures between the excited FC state, where the geometry is the

Table 4. The Overlap Integrals between MO's of TCNB Anion and Toluene Cation.

Geometry	$S(\theta_3\varphi_8)$	$S(\theta_3\varphi_{10})$	$S(\theta_3\varphi_{11})$	$S(\theta_4\varphi_8)$	$S(\theta_4\varphi_{10})$	$S(\theta_4\varphi_{11})$	$S(\theta_5\varphi_8)$	$S(\theta_5\varphi_{10})$	$S(\theta_5\varphi_{11})$
(i)	-0.00754	0.00235	-0.00117	-0.00222	0.00349	-0.00006	-0.00125	0.00083	-0.00083
(ii)-1	-0.01041	0.00379	-0.00031	-0.00399	-0.00511	0.00011	0.00059	-0.00027	-0.00013
-2	-0.00183	0.00066	-0.00006	-0.00068	0.00079	0.00002	0.00010	-0.00005	0.00004
-3	-0.00027	0.00010	-0.00001	-0.00010	0.00010	0	0.00002	-0.00001	0.00002
(iii)	0	-0.00078	0	-0.01132	0	0.00004	0	-0.00024	0

(i), (ii)-1, (ii)-2, (ii)-3 and (iii) represent models (i), (ii) with R_z 3.4 Å, (ii) with R_z 4.2 Å, (ii) with R_z 5.0 Å and (iii), respectively.

same as that in the ground state, and the excited equilibrium state is indicated theoretically in the present work.

The stabilization energy of the EDA complex in the ground state is due to the overlap between the wavefunctions of two components. According to the present calculation, the overlap integrals in the fluorescent state listed in Table 4 are small compared with those in the ground state.² This result is in accordance with the general argument that the overlap integral between MO's of two components takes larger value than that between the higher MO of one component and the lower MO of the other component. The stabilization of SCT through the overlap is mainly attributable to the interaction with BCT. However, the small value of the terms due to the overlap compared with the electrostatic terms and further decrease of the overlap caused by the CT seems to lead to the increase of the ionic character of the excited equilibrium state. The contributions^{of} various configurations to the fluorescent are listed in Table 5.

Table 5. The Contributions of Various Configurations to the Fluorescent State of TCNB-Toluene System.

	A(6-8)	B(8-10)	A(2-3)	G	BCT	SCT	A(7-8)	B(8-11)	A(1-3)
(i)	0.027	0.112	0.002	0.009	0.001	0.760	0.006	0.003	0.077
(ii)-1	0.035	0.155	0.008	0.033	0.001	0.765	~0	~0	~0
-3	0.012	0.060	0.005	~0	~0	0.921	~0	~0	~0
(iii)	0	0	0	0	0.009	0.990	~0	~0	~0

Since all the configurations except G and BCT have CT character, the strong ionic character of the fluorescent state is clearly demonstrated.

In the above discussion the value of back CT transition listed in Table 3 were used. The evaluated back CT transition by using eq. (7) are given as 2.07eV, 2.13eV, 2.42eV, and 2.37eV for benzen, toluene, mesitylene and mMB donors, respectively. Although the difference between the energy of B(8-10) and that of BCT is rather small, the effect of BCT on the CI calculation is small because of the small value of non-diagonal terms between BCT and the other configurations. For example, the calculated interaction elements between B(8-10) and BCT's are -0.105eV -0.153eV and 0.00024eV for models (i), (ii) and (iii) respectively. Then the electron donors are concluded to have little influence on the S_1-S_n absorption spectra in the observed region. The degenerate BCT's interact with each other through the intermolecular electrostatic interaction and the splitting of them is about 0.1~0.3eV.

2-4 Summary

The S_1-S_n absorption spectra of TCNB EDA complexes have been obtained by laser photolysis and by analyzing the re-absorption effect of the CT fluorescence by the excited EDA complex. Since the observed S_1-S_n absorption spectra are similar to those of TCNB anion, the electronic structure of TCNB EDA complexes in the lowest excited singlet state has been concluded to be quite polar. A

theoretical study on the excited EDA complex was made by considering the CI among the ground, CT, back CT and locally excited configurations of TCNB anion and donor cation. The following results were obtained theoretically. (i) The S_1-S_n absorption band of the complex is similar to the absorption band of TCNB anion. (ii) There is a considerable difference of the electronic structures between the excited FC state and the excited equilibrium state. (iii) The electronic structure (the polarities) of the excited equilibrium state of complexes with different donors are almost the same.

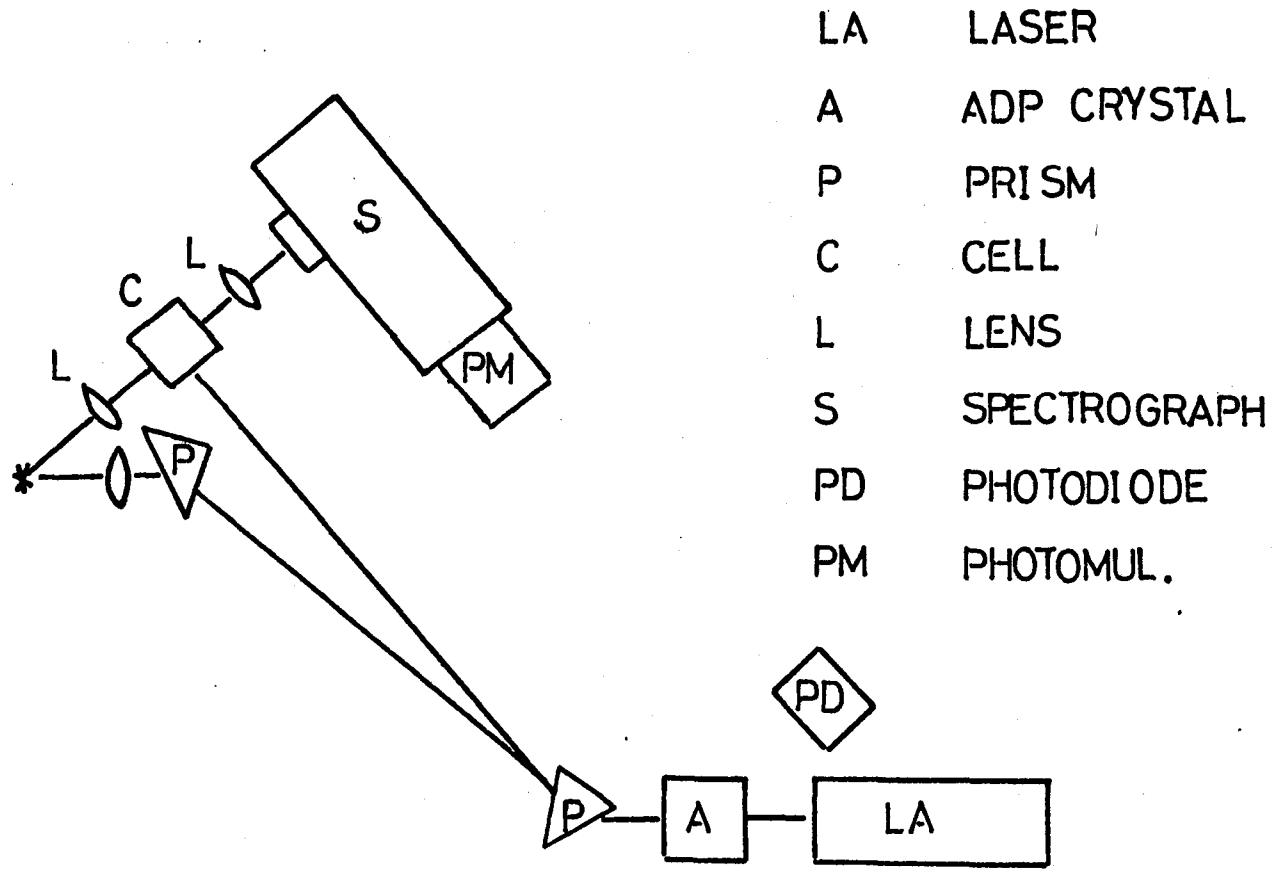

Fig. 1. Optical apparatus for laser photolysis.

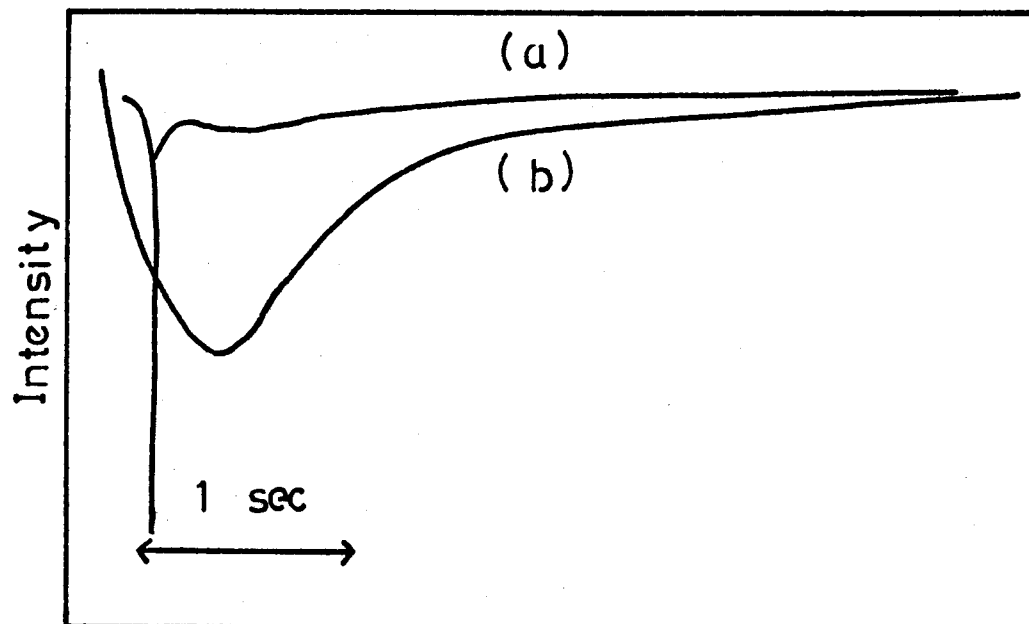

Fig. 2. Oscillograms of a Xe spark at 425 nm.

(a) With the triplet-triplet absorption of anthracene.

(b) Without the triplet-triplet absorption of anthracene.

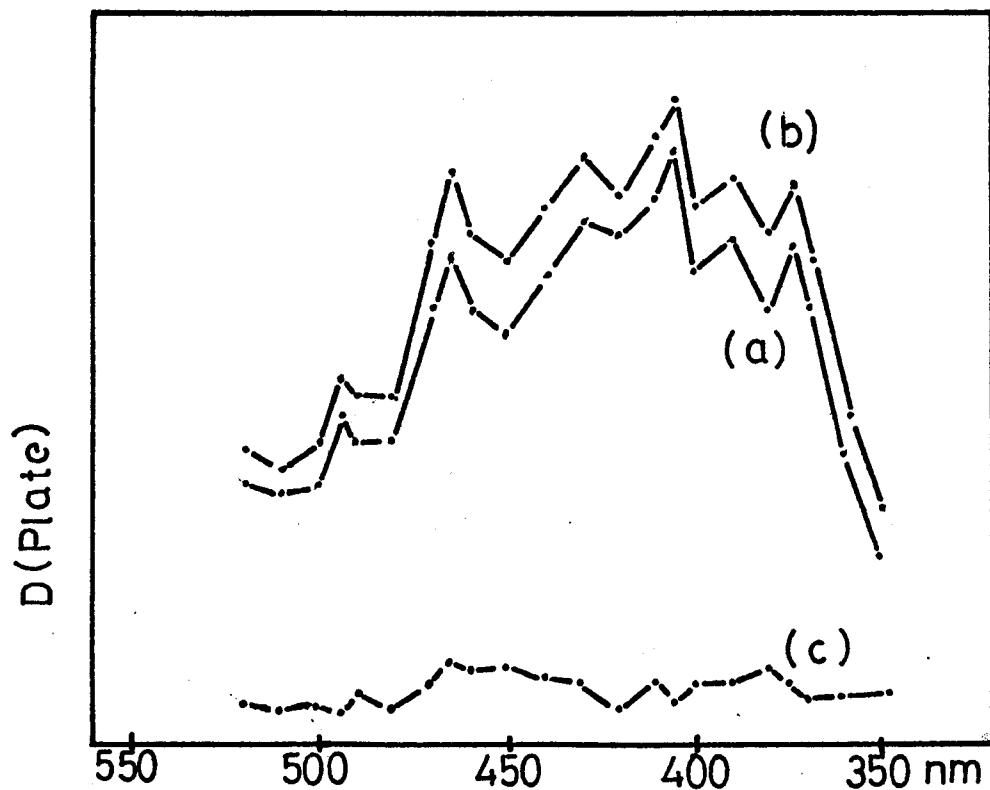

Fig. 3. The transient absorption spectra obtained by O_2 spark.

- (a) The emission spectra of O_2 spark through the excited sample.
- (b) The total emission of the fluorescence of TCNB-toluene and of O_2 spark through the unexcited TCNB-toluene.
- (c) The obtained transient absorption spectra.

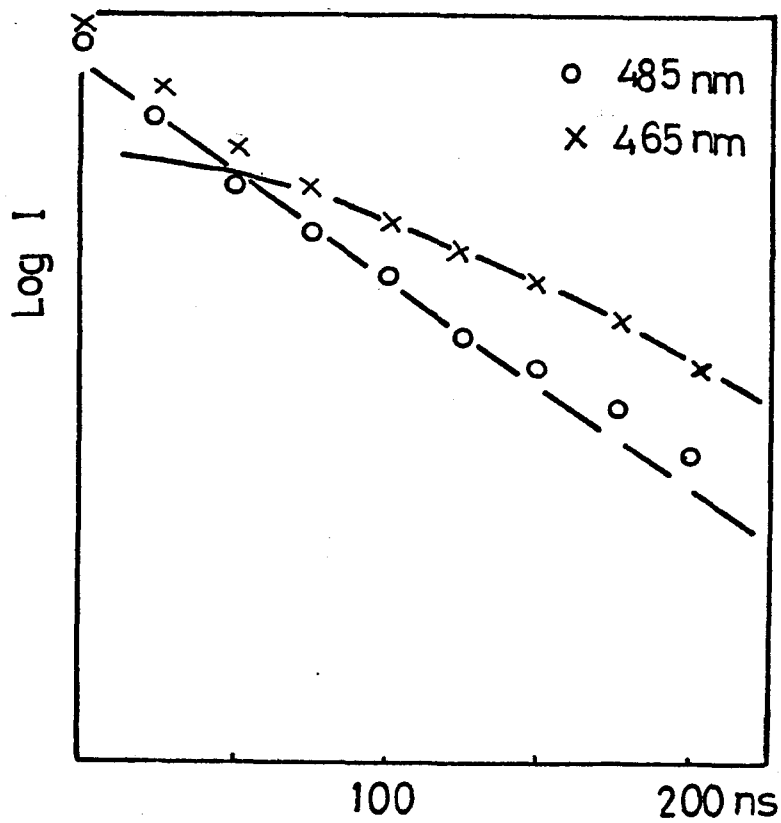

Fig. 4(a). Calculated (—) and observed (o,x) fluorescence decay curves of TCNB-toluene system.

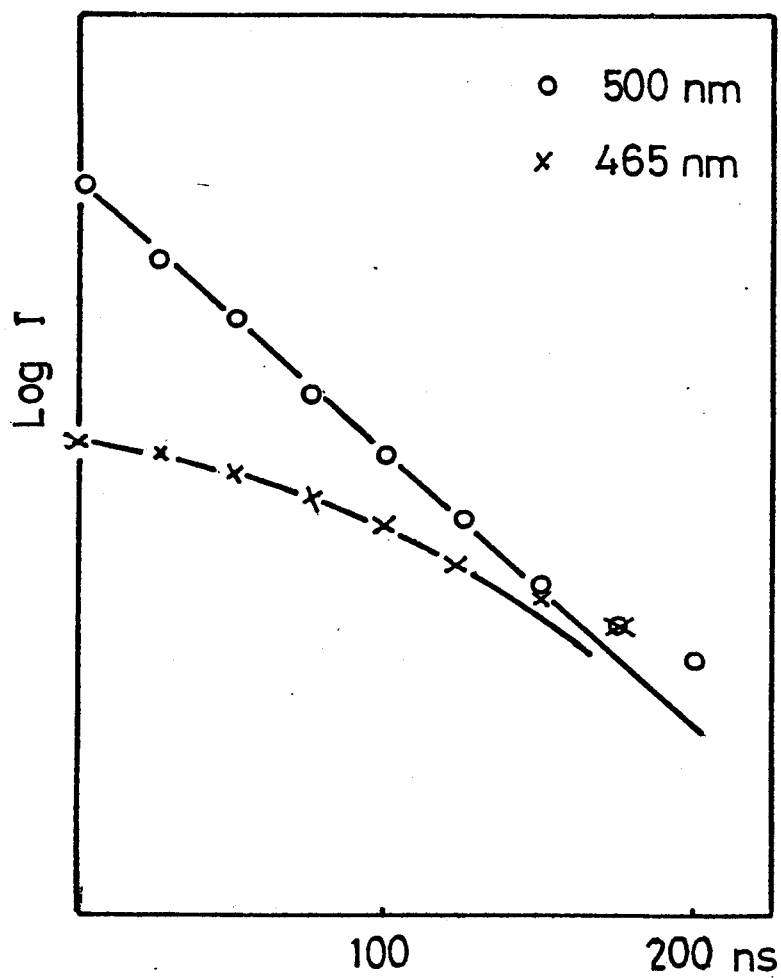

Fig. 4(b). Calculated (—) and observed (o,x) fluorescence decay curves of TCNB-benzene system.

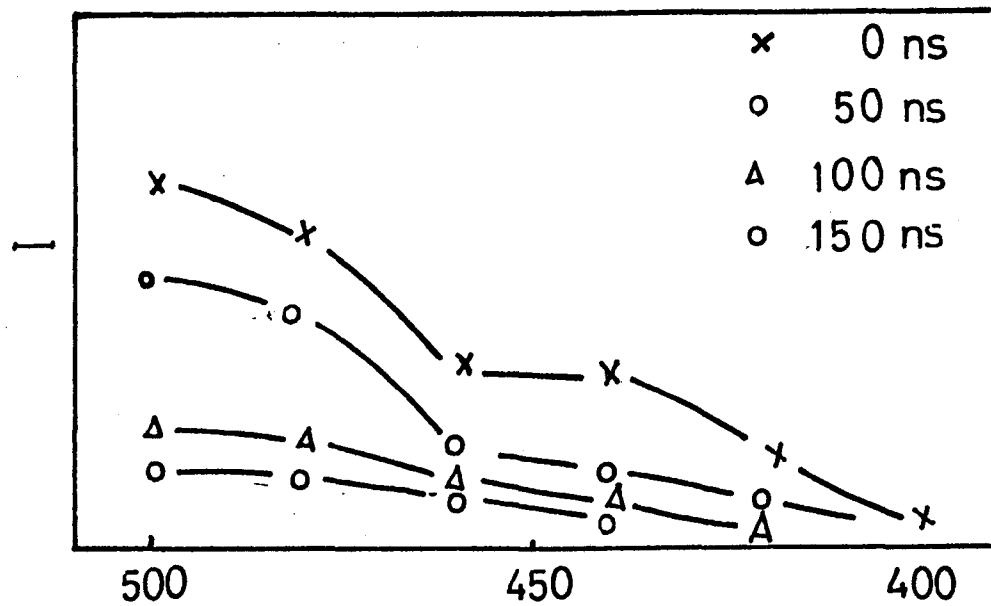

Fig. 5(a). The time-resolved fluorescence spectra of TCNB-toluene system.

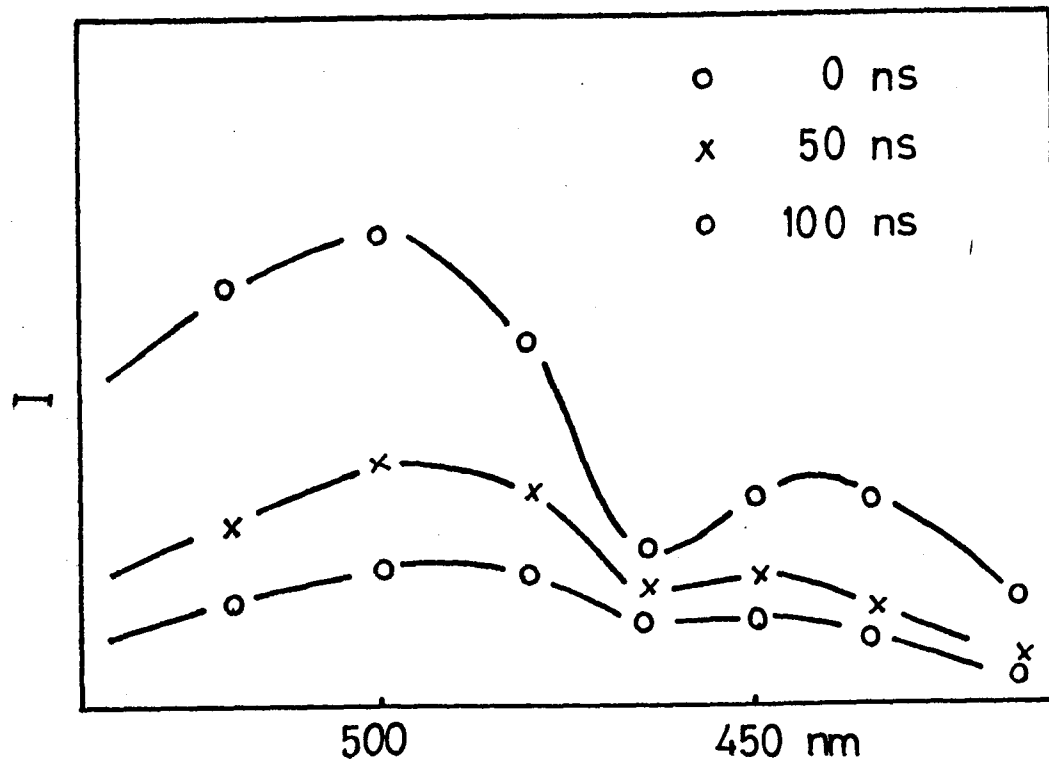

Fig. 5(b). The time-resolved fluorescence spectra of TCNB-benzene system

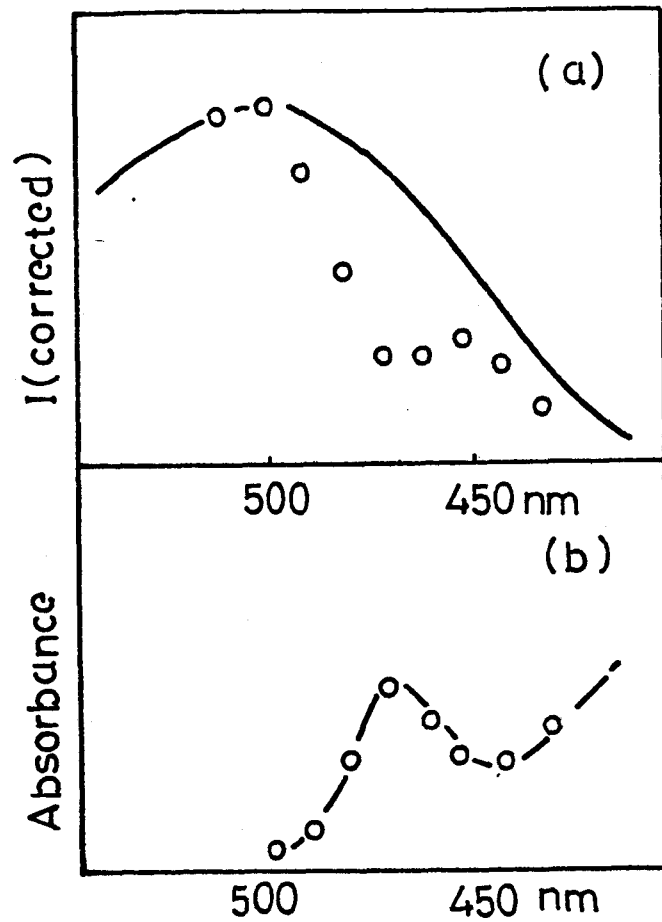

Fig. 6. Fluorescence spectra and S_1-S_n absorption spectra of TCNB-toluene complex.

(a) Fluorescence spectra measured by laser excitation (o) and by Aminco-Bowman spectrofluorometer (—).

(b) The S_1-S_n absorption spectra.

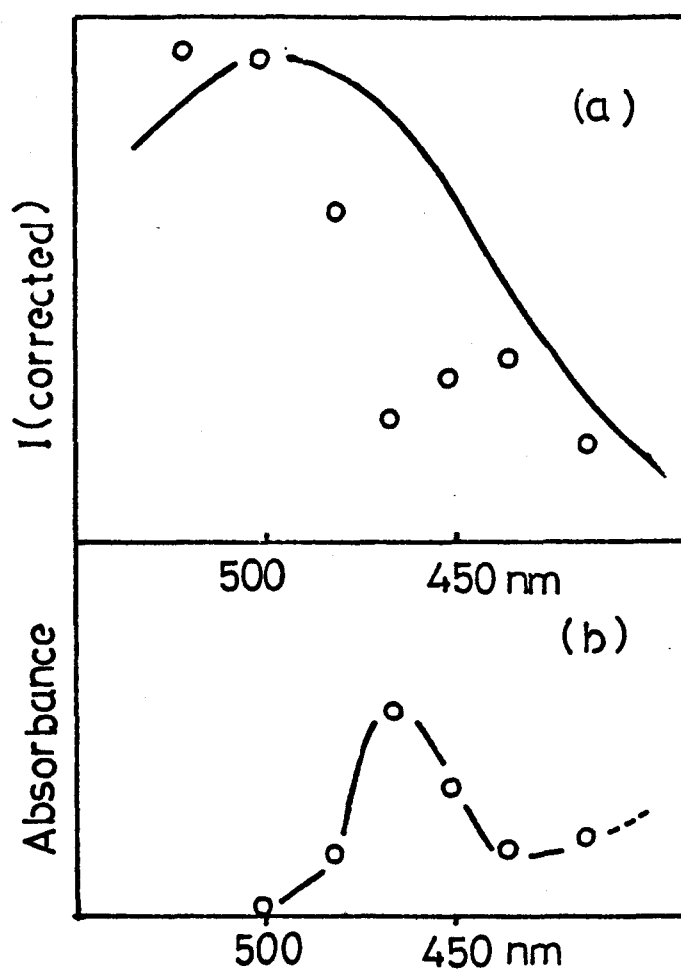

Fig. 7. Fluorescence spectra and S_1-S_n absorption spectra of TCNB-benzene system.

(a) Fluorescence spectra measured by laser excitation (o) and by Aminco-Bowman spectrofluorometer (—).

(b) The S_1-S_n absorption spectra.

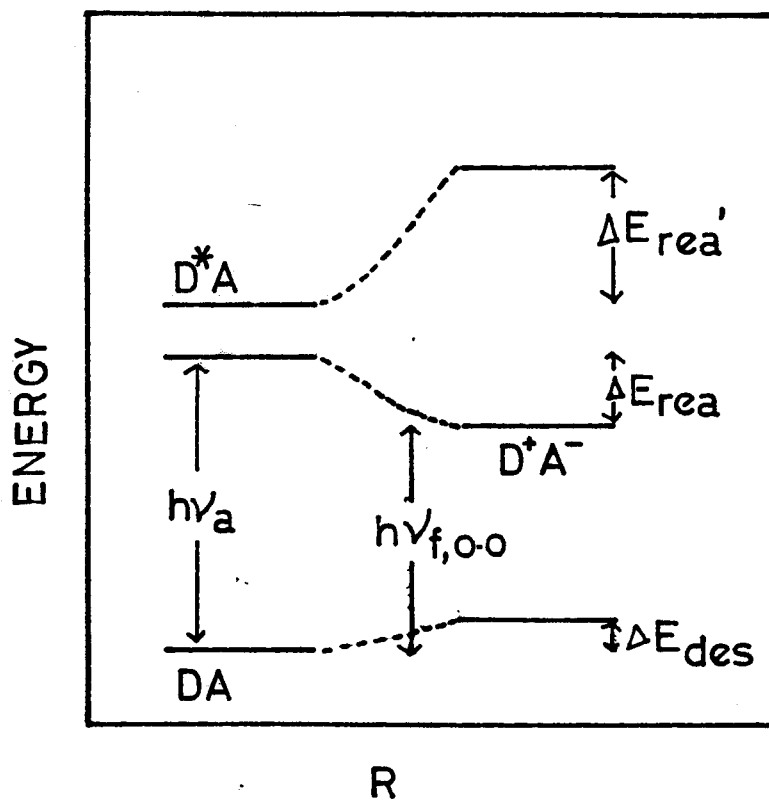

Fig. 8. Schematic diagram for the rearrangement energy.

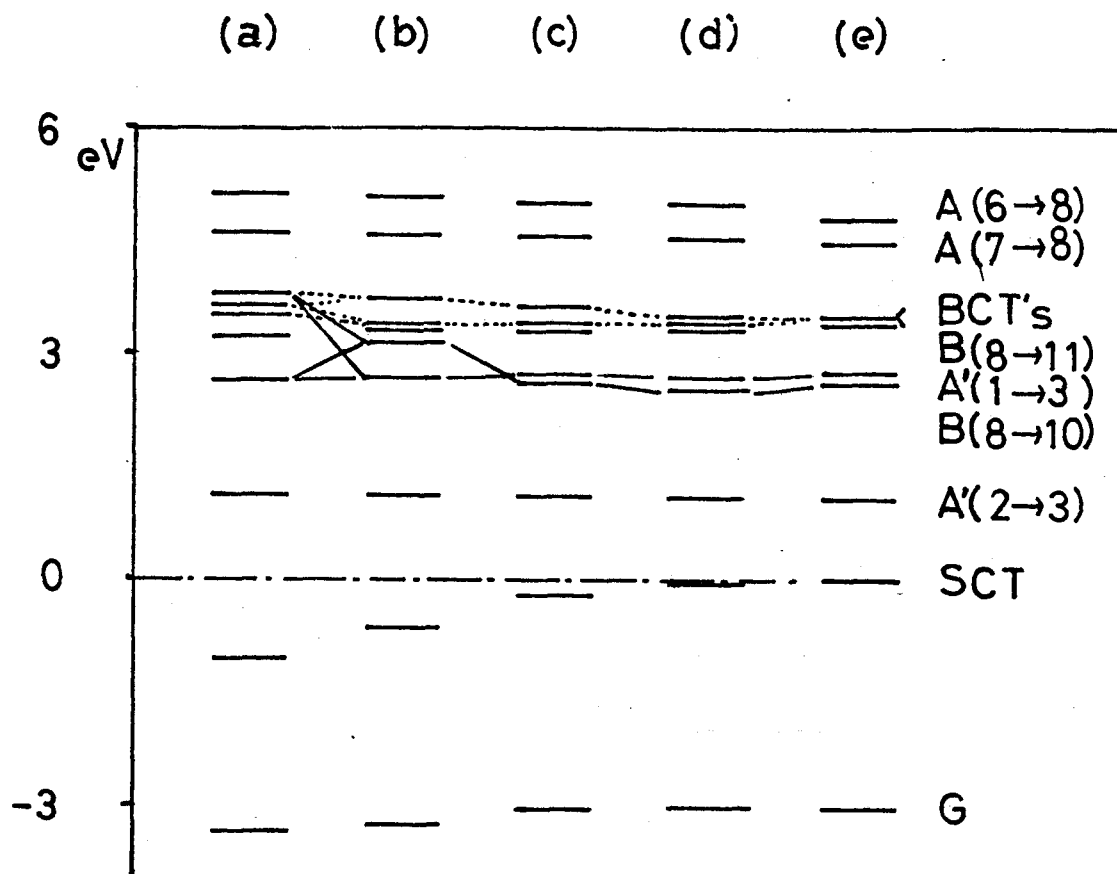

Fig. 9. Calculated results on the excited TCNB-toluene complex, comparing the effect of the different geometrical models.

(a) $R_x = 1.20$; $R_y = 0.695$; $R_z = 3.40 \text{ \AA}$.

(b) $R_x = 1.20$; $R_y = 0$; $R_z = 3.40 \text{ \AA}$.

(c) $R_x = 1.20$; $R_y = 0$; $R_z = 5.0 \text{ \AA}$.

(d) $R_x = 0$; $R_y = 0$; $R_z = 3.40 \text{ \AA}$.

(e) Without CI calculation.

CHAPTER III

THE IONIC DISSOCIATION OF THE ELECTRON DONOR-ACCEPTOR COMPLEX IN ITS LOWEST EXCITED SINGLET STATE

According to the simple theory of electron-donor-acceptor (EDA) complexes,¹ the excited state of the EDA complex produced by irradiating the charge-transfer (CT) band are in general considered to be polar. This simple expectation was confirmed by the preceding experimental and theoretical study and it has been shown that the electronic structures of these complexes in the lowest excited singlet state are quite polar and seem to be "contact ion-pairs".² This quite polar electronic structure is produced through the relaxation process from the Franck-Condon state to the fluorescent state. This relaxation process consists of the change in the electronic structure of the complex as well as the re-orientation stabilization, and moreover contains the re-orientation of the solvent due to the change in the electronic structure. On the other hand, at 77°K the so-called mirror symmetry relation between the fluorescence and absorption bands of the TCNB complexes holds and such an extensive solvation as at room temperature does not occur.³ From these results it has been concluded that the electronic structure of the excited EDA complex are very sensitive to the surrounding environment. Recently, we have shown that the ionic dissociation of TCNB-toluene complex in the lowest excited singlet state occurs in acetonitrile.⁴ Then, whether the CT fluorescence is observed or not and whether the excited EDA complex dissociates or not depend on the surrounding environment. In other words the primary process of the excited EDA complex is determined by the delicate condition of the solvent. Then, the interaction between the exci-

ted EDA complex and the surrounding solvents is considered to be important for the primary processes of photochemical reaction of EDA complexes.

It is well known that the ionic dissociation of heteroexcimer or the encounter-collisional ionization in the excited states occur,⁵ while studies on ionic dissociation of the excited EDA complexes are few.^{6,7} In both cases the absorption spectra of ion radicals have been measured only by the conventional flash photolysis method and no direct observation on the primary process of these production of ion radicals in nsec region has been performed. However, the study on the primary processes of ionic dissociations of EDA complexes is indispensable to give a general consideration on the electronic processes of weak EDA complexes.

In the present paper, the complete examination of the ionic dissociation of TCNB complexes in their lowest excited singlet states will be given firstly, using the fluorescence measurement, the measurement of the photocurrent induced by a laser excitation and nsec flash photolysis method. In the next the effect of solvents on the ionic dissociation will be reported and electronic processes of weak EDA complexes will be discussed in detail. The dissociation of complexes with different electron donors will be added.

3-1 Experimental

We have used a 347 nm pulse produced through the ADP frequency doubler^x as an exciting light source. The out-put power of a 347 nm pulse was measured with ballistic thermopile TRG model 100 (HADRON). The absorption spectra of the produced ion were measured with laser photolysis, on which the explanation was given in section 2-1. The rise and decay curves of ions were observed by the nsec flash photolysis method. Since a 50 Ω resistor is equipped to photomultiplier to obtain nsec time resolution, the monitoring light intensity falling onto the photomultiplier must be far greater than that of a usual conventional flash photolysis method. In nsec region this high light intensity is also required because the fluorescence intensity of the observed system is much higher than that of the usual monitoring Xe or tungsten lamp. This problem has been solved to some extent by using a Xe flash lamp as a monitoring light. The duration of the flash lamp was adjusted to be ca. 300 μ sec by inserting an appropriate coil into the electronic circuits of the power supply. The block diagram of the nsec flash photolysis apparatus is shown in Fig. 1. The timing circuit using a cathode-coupled multi, which makes the control of the delay time to trigger the monitoring flash lamp easily and linearly,⁸ is shown in Fig. 2.

The produced ion radicals were also observed by measuring the photocurrent induced by laser excitation. Although the problems of the measurement of the photocurrent will be reported by Tani-guchi and Mataga,⁹ the essential points are given here. The

direct irradiation on the electrodes was avoided by focusing the 347 nm pulse. The electrode was a Ni plate of 9 mm x 10 mm and spaced each other by 7 mm. To obtain the nsec time resolution a 50Ω resistor was used. The supplied dc voltage between electrodes was adjusted from 90V to 450V. The dc dark current was omitted by using the ac coupling of the input of Tektronix 585A synchroscope. The time constant of the electronic circuit is less than 5 nsec. For examining excitation light intensity effect on the photocurrent, the normal laser pulse was adjusted by using neutral filters composed of wire gauzes. The filters reduced the light intensity to 0.3%, 8%, 31.6% and 61%, respectively. The weaker signals of photocurrent were obtained by using Iwatsu cascade amplifier CA-2.

The fluorescence spectra and the relative quantum yields of the fluorescence were measured with an Aminco-Bowman spectrophoto-fluorometer.

Acetonitrile and mesitylene were purified by distillation. Benzene, toluene and ethylether (Merck, spectrograde), and 1,2-dichloroethane (Nakarai, spectrograde) were used without further purification. TCNB and hexamethylbenzene were the same samples as used before.³ All the solution were carefully degassed by an ordinary method.

3-2 Results

The Absorption Spectra of the Transient TCNB Anion by Laser Photolysis

The absorption spectra of the transient species at room temperature were measured photographically by using the laser-breakdown sparks in O_2 and Xe as spectro-flashes. The spectra obtained by exciting the TCNB-toluene complex to its lowest excited singlet state in acetonitrile solution are shown in Fig. 3. Since the observed transient absorption spectra are identical with those of TCNB anion,¹⁰ it has been proved that excitation of the CT absorption band of TCNB-toluene complex leads to the ionic dissociation of the complex in acetonitrile solution. The spectra of anion are observed more easily than the excited singlet-singlet (S_1-S_n) spectra of TCNB-toluene system. This anion decays in the course of several ten μ seconds. Some parts of the anion are quite stable and observable even by the usual spectrophotometer. No absorption band due to toluene cation was found, which may be ascribed to the following fact that the band of the cation is at ca. 460 nm¹¹ and may be hidden behind the band of TCNB anion.

The investigations upon other systems were performed, fixing the volume ratio of the donor solvent vs. a polar solvent to 1:2. The transient absorption spectra of TCNB anion produced by exciting the CT band of TCNB-toluene complex were also observed in isopropanol and in ethanol solution. The dissociation of other TCNB complexes were examined, and the absorption spectra of TCNB anion

in acetonitrile solution were observed with the present laser photolysis method in the cases of TCNB-benzene and TCNB-mesitylene complexes. In the case of latter complex the spectra of TCNB anion were also confirmed by the interesting technique, using the fluorescence of cyclohexane solution of tetraphenylbutadiene as a flash light.¹² Since this fluorescence has a short lifetime, the flash light has the same shape as an exciting laser pulse and this technique is convenient to observe short-lived species.

Thus, the ionic dissociations of TCNB complexes caused by exciting the CT bands in polar solvents are observed commonly for various TCNB complexes.

The Rise Curve of TCNB Anion by Nsec Flash Photolysis

The rise and decay curves of TCNB anion was obtained by the nsec flash photolysis, developed in the present work. The earlier stage of the decay of TCNB anion at 465 nm are given in Fig. 4. The referential oscillogram, using a Xe spark as a spectra-flash, are also shown in Fig. 5. These oscillograms show that the laser-induced production of anion is completed rapidly. Since in acetonitrile solution no CT fluorescence of TCNB-toluene complex was observed, the direct kinetic relation between the fluorescence decay and the rise curve of TCNB anion, which is an evidence for the ionic dissociation of the complex in the lowest excited singlet state, was not obtained for this system.

Measurements of the Transient Photocurrent Induced by Laser Excitation

Recently, the S_1-S_n spectra of TCNB-toluene and TCNB-benzene complexes have been reported by us,² and they are quite similar to the spectra of TCNB anion. We cannot distinguish the solvated anion from the "contact ion-pair" of excited TCNB-toluene complex by measuring only the absorption spectrum, although the dynamical behavior of this anion is different from that of the excited TCNB-toluene complex. We have measured the photocurrent induced by laser excitation of TCNB complexes in various solvents since this may be another useful method for examining the photoionization. It has been shown that the obtained photocurrent is due to the dissociated TCNB anion and toluene cations, by comparing the rise and decay curves of the photocurrent with those of the absorption of TCNB anion. The kinetic relation between the transient photocurrent and the transient absorption of the anion are given in Fig. 6. The rising curve and earlier stage of the decay of the photocurrent are almost the same as those of the absorption of TCNB anion. However, at the later stage of the decay a difference between the photocurrent and absorption appears. This difference may be due to secondary reactions as well as the dark current, which is due to dark reaction occurring at electrodes because of high applied electric field.^{9,13} In spite of the above problem concerning the measurement of the photocurrent, the observed photocurrent induced by laser excitation can be ascribed to the dissociated ion radicals. The rise

curve in the case of TCNB-toluene-acetonitrile and the excitation laser pulse are given in Fig. 7. The shape of the rise curve is the same as that of the time-integrated function of an exciting laser pulse. The same results are obtained in all other TCNB complexes in various solvents at room temperature.

We can observe both the CT fluorescence of TCNB-benzene complex and the photocurrent due to the dissociated ions in 1,2-dichloroethane solution. As shown in Fig. 8, the observed results show that the lifetime of the fluorescence is very short and the production of ion radicals is rapid.

The measurement of the photocurrent of aerated TCNB-toluene acetonitrile system was also performed and it was found that the production of TCNB anion in aerated system was almost the same as that in the degassed system. However, the decay of the ion in aerated solution is faster than that in degassed solution.

3-3 Discussion

Ionic Dissociation of TCNB Complexes in Their Lowest Excited Singlet States

Since a laser pulse is an intense exciting light, two-photon process, a two-step process with the excited singlet state as an intermediate and the collision process between the excited EDA complexes followed by ionic dissociation must be examined to elucidate the primary process of the dissociation. This problem was

studied by examining the excitation light intensity effect on the photocurrent.

In general the photocurrent density is given by¹⁴

$$i(t) = \sum_j z_j e n_j(t) \mu_j E \quad (1)$$

where z_j , μ_j and $n_j(t)$ represent an electric charge, the mobility and the number of the carrier j in unit volume, respectively. E is an applied electric field. In the present system of TCNB complexes, the charge carriers are TCNB anions and donor cations, and eq. (1) is reduced to the following equation.

$$i(t) = en(t)(\mu_+ + \mu_-)E \quad (2)$$

Since both ions are simultaneously produced by laser excitation and disappear by the recombination reaction, we have eq. (3).

$$\frac{dn}{dt} = aI - bn^2 \quad (3)$$

where a and b represent the rate constants of production and the disappearance of ions, respectively. I is the intensity of the exciting light. In the present cases of TCNB complexes in various solvents at room temperature, the dissociation into ion radicals occurs quite rapidly in nsec region while they decay slowly during the times more than ten μ seconds. Then the maximum value of the photocurrent, which is obtained immediately after the excitation, is proportional to the concentrations of the dissociated ions.

The excitation intensity effect on the maximum value of the photocurrent of TCNB-toluene-acetonitrile system is given in Fig. 9. The liner relation shows that this ionic dissociation is a

one-photon process.¹⁵ Then, it is concluded that the TCNB complexes in their excited CT singlet states dissociates spontaneously into ions in polar solvents. As mentioned before, the production of ions were also observed in aerated acetonitrile solution of TCNB-toluene complex. This experimental result is also consistent with ionic dissociation of the complex in its lowest excited CT singlet state.

Electronic Processes of TCNB-benzene and TCNB-toluene Complexes in Various Solvents.

The ionic dissociation of excited TCNB-benzene and TCNB-toluene complexes in various solvents were studied in detail, fixing the volume ratio of the donor solvent vs. a polar solvent to 1:2. Dielectric constant of the solution was calculated by the equation $\epsilon = \sum_i v_i \epsilon_i$, where v_i and ϵ_i represent the volume fraction and dielectric constant of the solvent i , respectively. The relative quantum yields of ionic dissociation were obtained by calibrating an applied electric field and excitation photons and by comparing the peak photocurrent.

We made an order estimation of the absolute quantum yield of dissociation in the following way; (1) The effective diameter of 347 nm pulse at the front face of the cell was determined from the burned spot of a colour sheet and distribution of the exciting photons was assumed to be uniform. (2) The distribution of TCNB anion in the monitoring portion of the sample cell was averaged.

(3) The absorption coefficient of TCNB anion at 465 nm was assumed to be 10^4 . (4) The optical density of TCNB anion obtained immediately after the excitation was used.

The lifetime and the relative quantum yields of fluorescence were measured by the usual method.³ All the results for TCNB-benzene and TCNB-toluene complexes are listed in Table 1 and Table 2.

Table 1. Results on the ionic dissociation and the fluorescence of TCNB-benzene complex.

solvents	ϵ	fluorescence lifetime	rel. Q.Y. ^a of fluorescence	rel. Q.Y. of dissociation
benzene	2.3	~100 nsec	1.0 (0.09) ^b	~0
ethylether	4.3		0.23(0.02)	~0
1,2-dichloroethane	10.4	~10	0.04(0.004)	0.01(0.001)
acetone	20.7	-	~0	0.42(0.04)
acetonitrile	37.5	-	~0	1.0 (0.1)

(a) rel. Q.Y. is the abbreviation of relative quantum yield.

(b) The values in parenthesis are absolute quantum yields.

Table 2. Results on the ionic dissociation of TCNB-toluene complex.

	ϵ	rel. Q.Y. of dissociation	Appearance of absorption of TCNB anion
toluene	2.4	~ 0	No
ethylether	4.3	~ 0	No
1,2-dichloroethane	10.4	0.01	No
isopropal	18.3	0.09	Yes
ethanol	24.3		Yes
acetonitrile	37.5	1.0	Yes

Now a general understanding on the electronic processes of the excited TCNB-benzene and TCNB-toluene complexes may be given as follows. The effect of the surrounding environments on the excited EDA complex can be divided into two parts. The first is its effect on the electronic structure of the excited complexes, and the re-orientation of the solvent as well as the intermolecular configuration transformation of the complex determine the electronic structure. Thus, at room temperature the excited equilibrium state is a "contact ion-pair", while at 77°K the excited state seems not to be so polar as at room temperature since the mirror^Y relationship between the fluorescence and absorption bands holds.^{2,3} The second is its effect on the electronic processes of excited EDA complexes at room temperature. Although the electronic structures of EDA complexes are quite polar even in nonpolar solvents, electronic pro-

cesses of excited complexes depend upon the polarity of the surrounding solvents. The CT fluorescence is observed in nonpolar solvents, while ionic dissociations occur in polar solvents.

About a tenth part of the transition from the excited singlet state to the ground state is effected by the polarity of the surrounding solvents as shown in Table 1. The remaining part of the transition is the non-fluorescent and nondissociative transition, which may be due to a rather intrinsic character of the EDA complexes. It is expected that the interaction between two components of the excited complex is the same order in strength as the solvation in the case of weak EDA complexes such as TCNB-benzene and TCNB-toluene. Detailed studies on the electronic processes are required to clarify such a problem.

Ionic Photo-Dissociation of TCNB Complexes with Different Donors

The ionic dissociation of TCNB complexes with different methyl-substituted benzenes in acetonitrile solution were studied, fixing the volume ratio of the donor solvent vs. acetonitrile to 1:2, except the TCNB-hexamethyl benzene (HMB) complex. The results are listed in Table 3, where the fluorescence lifetimes were observed in nonpolar solvents. The yield of ionic dissociation in acetonitrile solution of TCNB complexes decrease from benzene and toluene donors to hexamethylbenzene donor.

Table 3. Results on the ionic dissociation of TCNB complexes with methyl-substituted benzenes in acetonitrile solution.

donors	rel. Q.Y. of dissociation	Appearance of absorption of TCNB anion	fluorescence lifetime
benzene	1.0	Yes	~100 nsec
toluene	1.08	Yes	~100 nsec
mesitylene	0.43	Yes	43 nsec ¹⁶
HMB	0.05	No	5 nsec ¹⁶

The S_1-S_n absorption spectra of TCNB-HMB complex have not been found, although the S_1-S_n spectra of TCNB-benzene and TCNB-toluene complexes and of TCNB-mesitylene complex were observed by analyzing the re-absorption of CT fluorescence and by directly measuring the absorption band with nsec flash photolysis method, respectively. On the other hand, the electronic structure of the excited equilibrium state of TCNB complex has been shown to depend little upon the donor according to our theoretical consideration. Thus, the above results of the ionic dissociation of various TCNB complexes appear to contradict with the theoretical consideration. This contradiction may be removed by considering the fluorescence lifetimes of these complexes. The lifetimes of the CT fluorescence of TCNB-mesitylene and TCNB-HMB are 43 nsec and 5 nsec,¹⁶ respectively. Owing to these short lifetimes, it seems to be difficult to observe the S_1-S_n absorption spectra of TCNB-mesitylene and TCNB-

HMB complexes and the dissociation yields of these complexes may be low. Rather short lifetimes may be due to the large value of the intra-complex radiationless transition probability constant. This consideration on the short fluorescence lifetimes is, of course, the same as that given in the previous section. Although detailed quantitative studies on the radiationless processes of the EDA complexes are required for the elucidation of this problem, a more detailed examination on the electronic processes of weak EDA complexes will be given in the near future.

3-4 Summary

(i) From the present nsec laser experiments it has been concluded that the TCNB complexes in their lowest excited singlet states dissociate spontaneously into ions in polar solvents.

(ii) The effect of the solvents on the electronic processes of excited TCNB-benzene and TCNB-toluene complexes are elucidated in detail. About a tenth part of the transition from the excited singlet state to the ground state is affected by the polarity of the solvents. The CT fluorescence is observed in nonpolar solvents while ionic dissociation occur in polar solvents. The remaining part of the transition is the nonfluorescent and nondissociative one, which may be due to a rather intrinsic character of the EDA complexes. It is expected that the interaction between two components of the excited complex is the same order in strength as the solvation.

(iii) The yield of ionic dissociation in acetonitrile solution of TCNB complexes decreases from benzene and toluene donors to HMB donor. The low yields in the cases of TCNB-mesitylene and TCNB-HMB are explained well with their short fluorescence lifetime in nonpolar solvents, which may be due to the large value of the intra-complex radiationless transition probability constant.

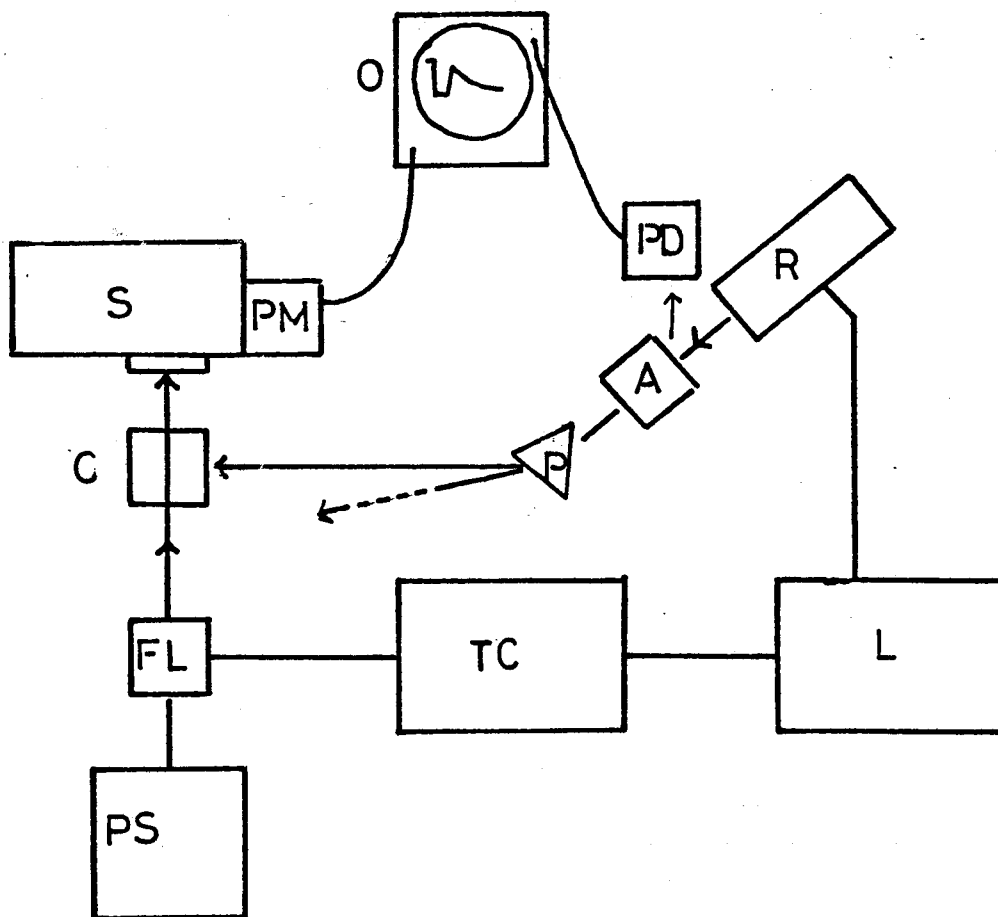

Fig. 1. The block diagram of the nsec flash photolysis apparatus. R, ruby; A, ADP frequency doubler; P, separating prism; C, sample cell; L, laser power supply; TC, timing circuit; PS, power supply; FL, monitoring flash lamp; S, spectrograph; PM, photomultiplier; PD, photodiode; O, oscilloscope.

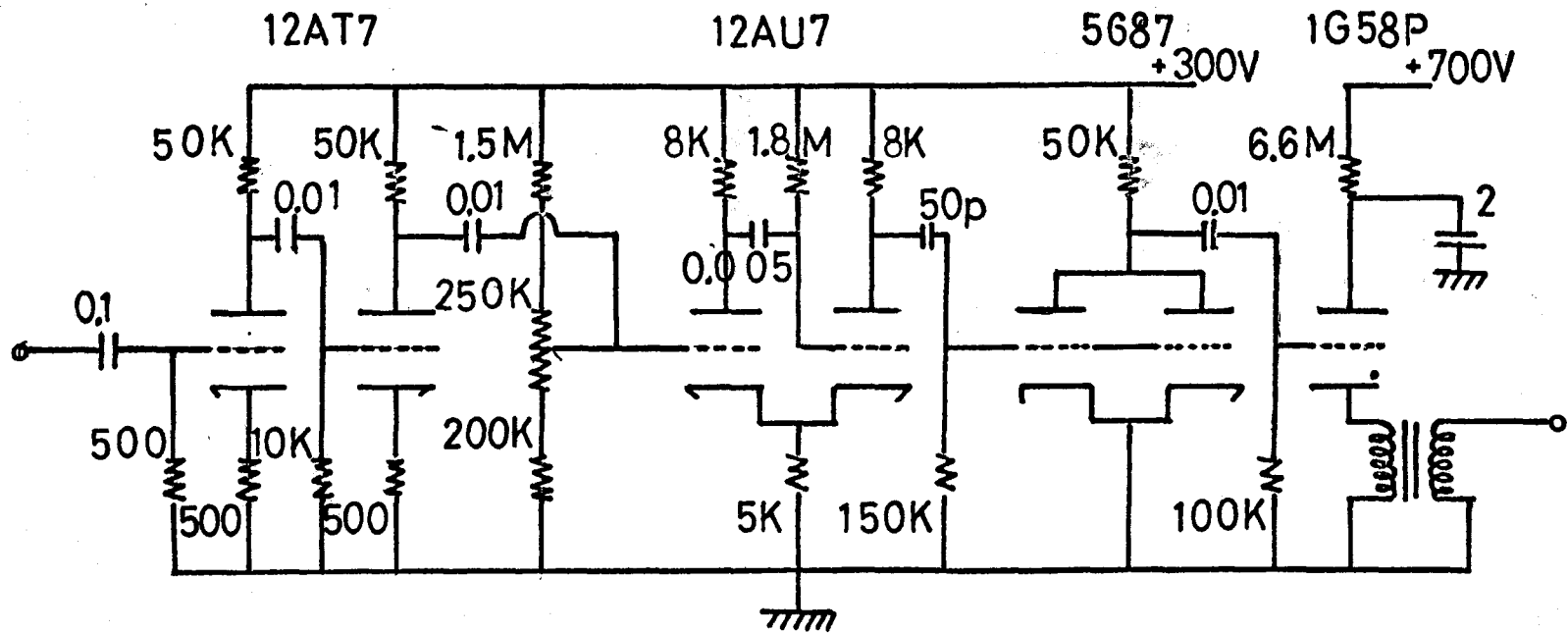

Fig. 2. The timing circuit.

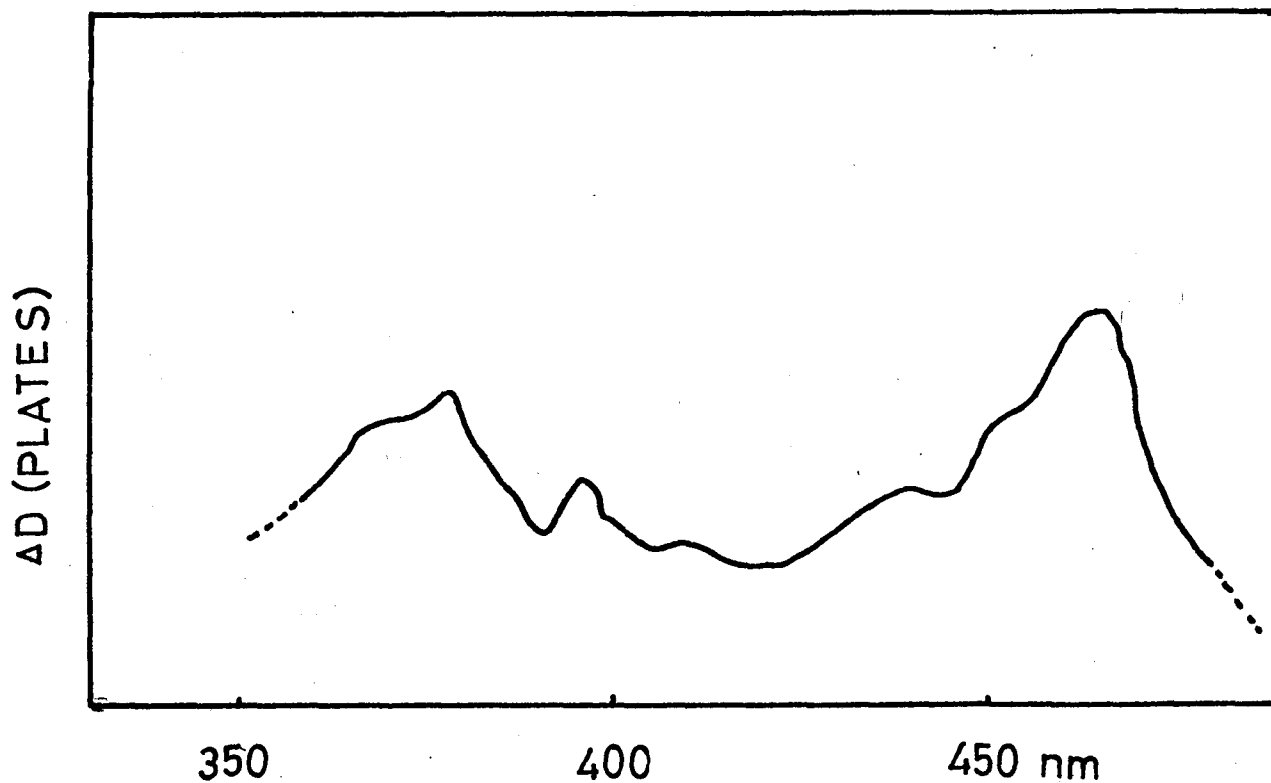

Fig. 3. The transient absorption spectra of TCNB-toluene-acetonitrile system. Concentration of TCNB; $6 \times 10^{-3} \text{M}$. Volume ratio of toluene vs. acetonitrile, 1:2.

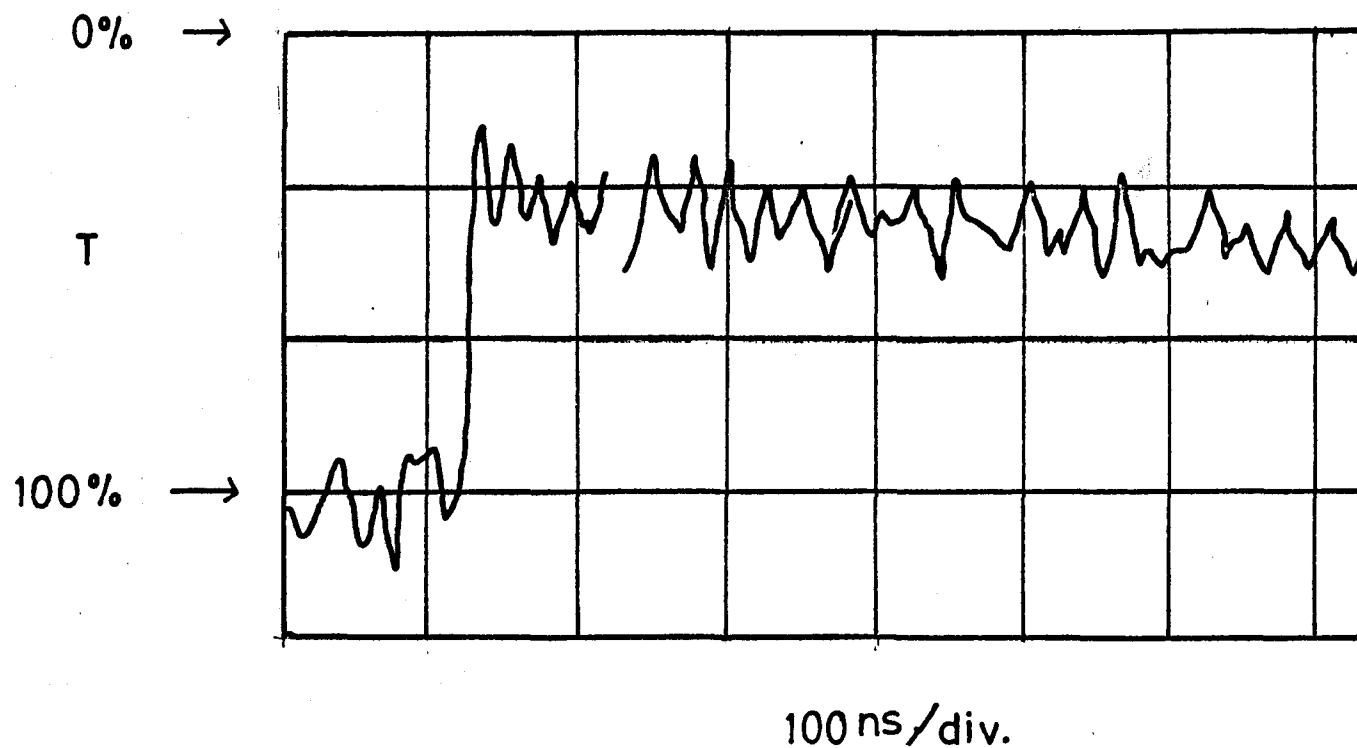

Fig. 4. The rise and decay of the absorption of TCNB anion produced by irradiating TCNB-toluene-acetonitrile system. Observed at 465 nm.

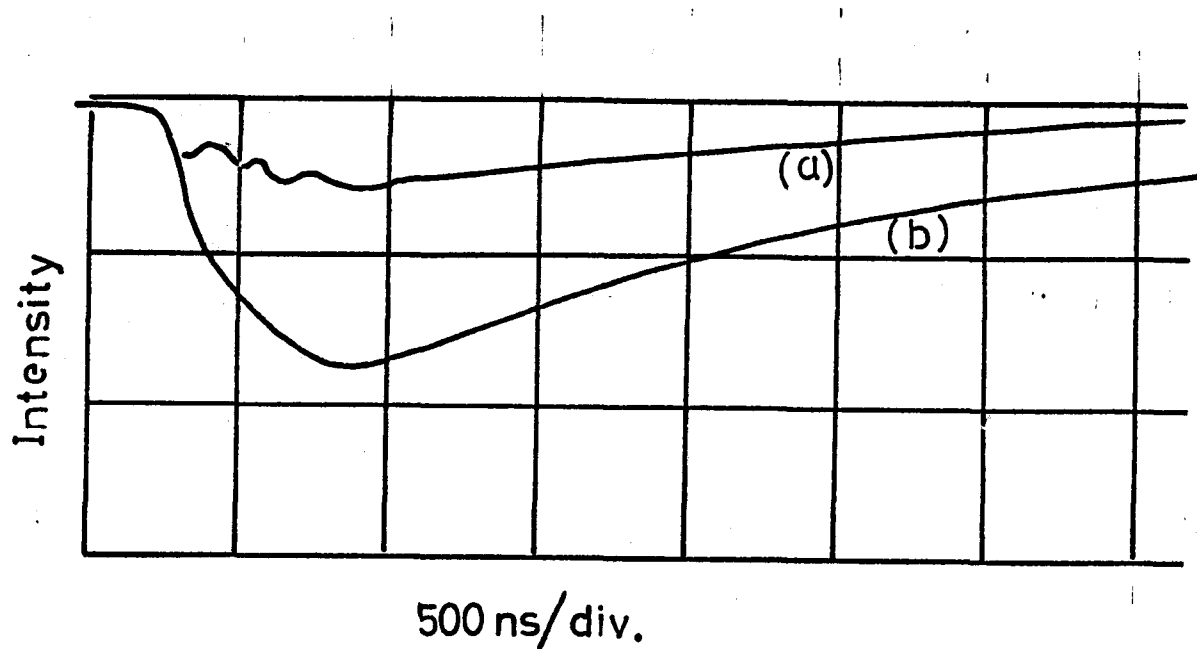
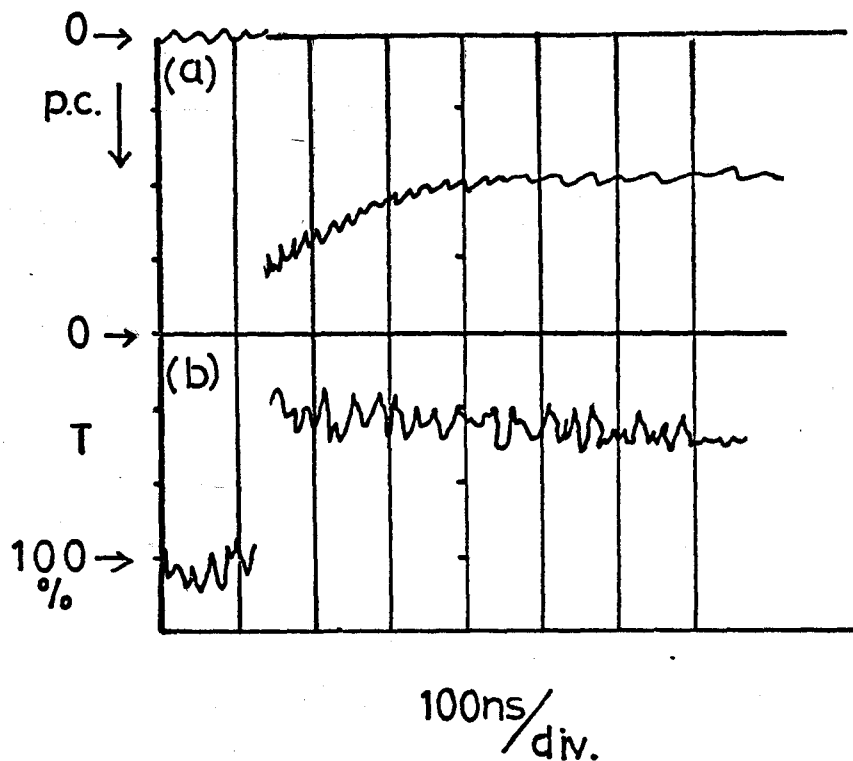

Fig. 5. Oscillograms of a Xe spark at 465 nm.

(a) With the absorption of TCNB anion produced by irradiating TCNB-toluene-acetonitrile system.

(b) Without the absorption of TCNB anion.



(a) photocurrent (b) absorption

Fig. 6. The kinetic relation between the transient photocurrent and the absorption of TCNB anion, produced by irradiating TCNB-toluene-acetonitrile system.

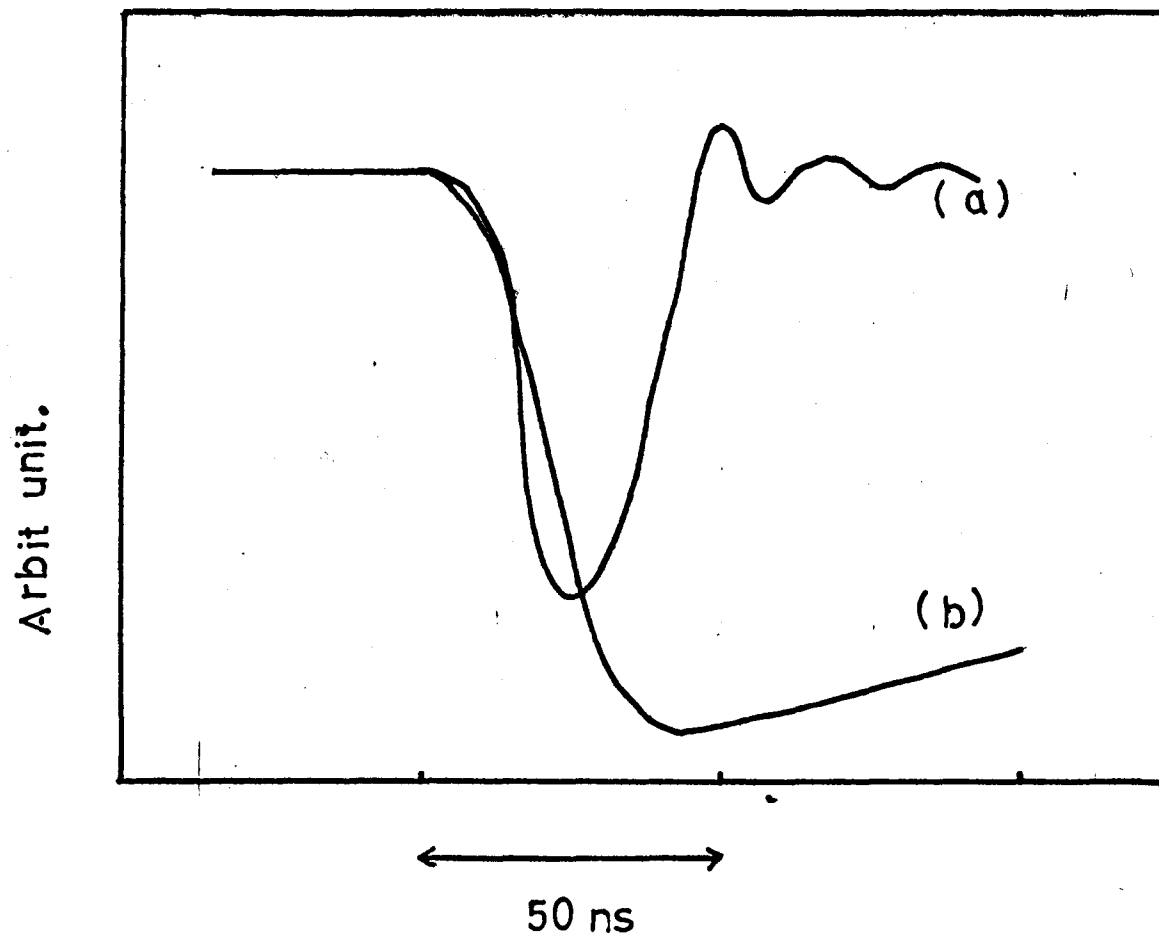

Fig. 7. The rise and decay of the photocurrent in the case of TCNB-toluene-acetonitrile system. (a) a laser pulse, (b) the transient photocurrent.

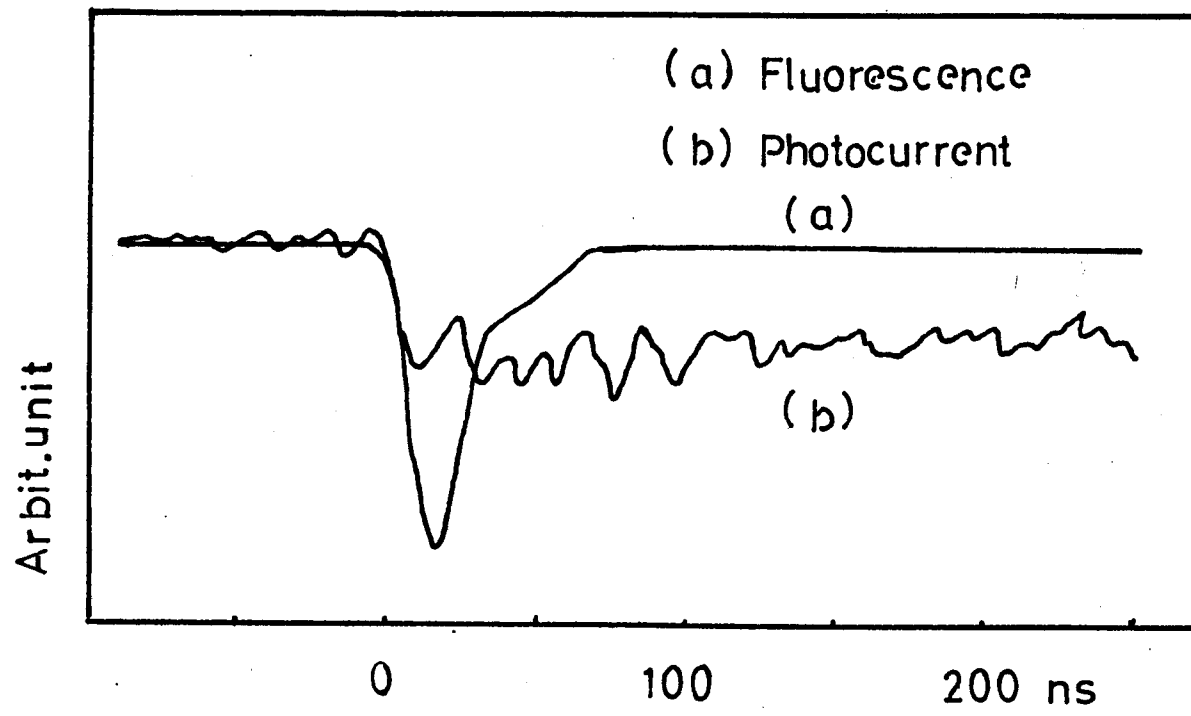

Fig. 8. The kinetic relation between the photocurrent and the CT fluorescence in the case of TCNB-benzene-1,2-dichloroethane system.

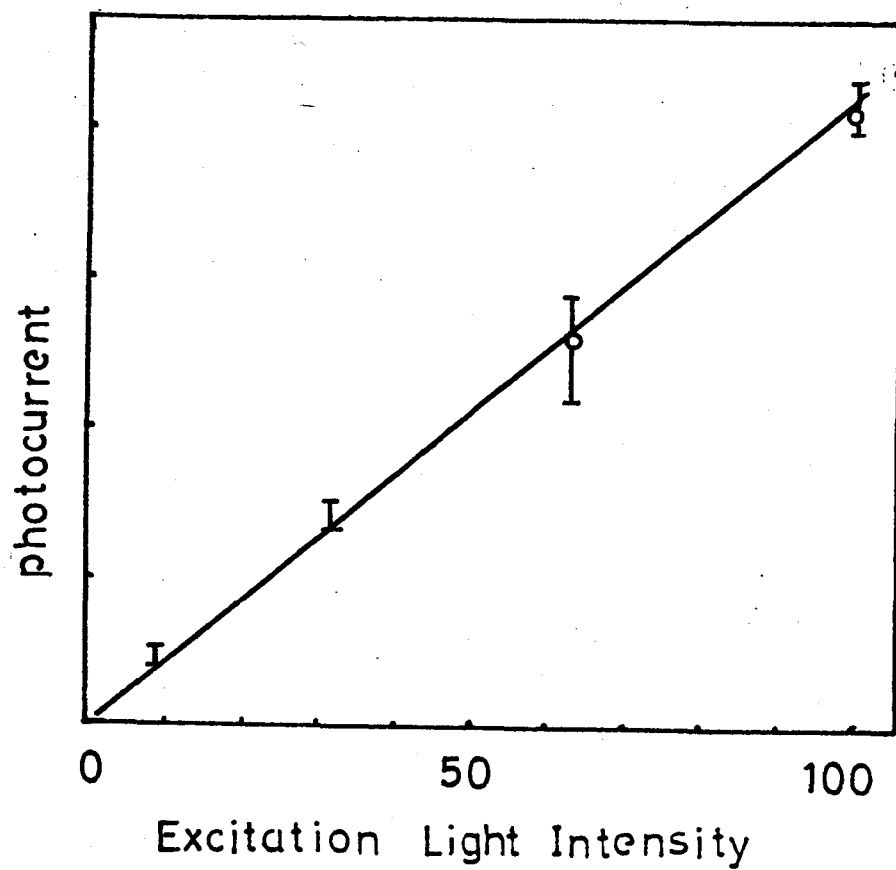

Fig. 9. The excitation intensity effect on the peak photocurrent of TCNB-toluene-acetonitrile system.

CHAPTER IV

INTERACTIONS BETWEEN EXCIPLEXES AND BETWEEN EXCITED
ELECTRON DONOR-ACCEPTOR COMPLEXES IN SOLUTION

Since the irradiation of solutions with some kind of laser can produce excited states quite densely, it may be expected that there arise some interactions between those excited states.

Actually, an interaction between pyrene excimers has been demonstratedⁿ by using a pulsed N_2 laser.¹ It may be expected also that an interaction between exciplexes can be observed not only in the case of excimer but also in the case of heteroexcimer.

In this paper the results on anthracene-*N,N*-dimethylaniline (DMA) heteroexcimer and pyrene excimer will be reported.² Anthracene is an appropriate solute for studying the interaction between the heteroexcimers, since it forms no excimer. Pyrene forms excimer readily and is also appropriate solute, although its molecular extinction coefficient at 347 nm is rather small. The high intensity irradiation of these concentrated solutions leads to the lifetime shortenings and non-exponential decay of exciplex fluorescence. The analysis of fluorescence decay curves shows that the bimolecular interaction between exciplexes contributes to the disappearance of exciplexes.

The solutions of anthracene-DMA system and those of pyrene were excited with the 347 nm laser pulse. For the excitation with relatively low intensity light, the laser pulse was adjusted by using neutral filters composed of wire gauzes. The filters reduced the light intensity to 0.3%, 8% and 31.6% respectively. For the high intensity excitation, the pulsed beam without filters was focussed on the front face of the solution. In the case of rather dilute

solutions, such as solutions of 5×10^{-4} M anthracene and 0.1M DMA in ethylether and of 10^{-2} M pyrene in cyclohexane, the decay curves have nothing to do with the excitation light intensity and are exponential. In the case of concentrated solutions, such as benzene solution of 0.05M anthracene and 2M DMA and toluene solution of 0.25M pyrene, the decay curves are ^{almost} exponential only when the excitation intensity is reduced to 0.3% of 347 nm out-put. With higher excitation intensity, however, the fluorescence decay of these concentrated solutions are shortened and are not exponential. Nevertheless, in the latter case, the curve is exponential at the later stage of the decay and the lifetimes estimated from these exponential part are identical with those obtained in the case of the excitation intensity reduced to 0.3%. The half-value-width of the fluorescence decay function ^Y at 500 nm, at which no monomer emission is observed, are listed in Table 1. The shape and band position of the fluorescence spectra of exciplexes have nothing to do with the excitation light intensity.

Table 1. Half-value-width of the fluorescence decay function.

Solutions	Excitation Light Intensity			
	0.3%	8%	100%	focussed
Anthracene 0.05M & DMA 2M in benzene	65 ns	45 ns	35 ns	30-37 ns
Anthracene 5×10^{-4} M & DMA 0.1M in ethylether	85	70	80	65
Pyrene 0.25M in toluene	40	35	28	25
Pyrene 0.01M in cyclohexane	45-65	65	60	60

Usually the exciplex fluorescence disappears unimolecularly and the decay curve is given as follows.

$$E = E_0 e^{-at} \quad (1)$$

$$\frac{1}{E} = \frac{1}{E_0} e^{at} \quad (2)$$

where E is the concentration of fluorescent state, E_0 is the value of E at $t=0$ and a is the rate constant of unimolecular decay.

When the exciplex is produced densely with laser excitation, it is expected that the intermolecular interaction of exciplex can occur and by this interaction the exciplex decays bimolecularly. In this case, the rate equation can be given as

$$\frac{dE}{dt} = -aE - bE^2 \quad (3)$$

where b is the rate constant of bimolecular decay. The integrated solution of eq. (3) is

$$\frac{1}{E} = \left(\frac{1}{E_0} + \frac{b}{a} \right) e^{at} - \frac{b}{a} \quad (4)$$

Plotting $\frac{1}{E}$ against e^{at} , straight lines are expected in both cases of eq. (2) and eq. (4). The difference between eq. (2) and eq. (4) is in the value of the intercepts of these straight lines.

Our experimental results were analyzed according to the above method, as indicated in Fig. 1 and Fig. 2. In the case of low

intensity irradiation of concentrated solutions and in the case of dilute solutions, the obtained lines pass the origine. However, in the case of high intensity irradiation of concentrated solutions, the value of the intercept is negative. Then, it can be concluded that the intermolecular interaction of heteroexcimer as well as excimer occur in the latter case. An estimation of the effective concentration of exciplex in the range of thickness $\sim 10^{-3}$ cm at the front face gives ca. 5×10^{-3} M. Under this concentration the bimolecular collisional interaction of exciplexes controlled by diffusion, can occur.

In the above discussion the bimolecular collision of exciplexes is assumed to lead to the radiationless degradation of both exciplexes. But it may also be expected that the excited state of exciplex is formed under the bimolecular collision in the way similar to the case of triplet-triplet annihilation. Although the produced excited state of exciplex has a much larger energy compared to the binding energy of the exciplex, the rapid radiationless transition to the fluorescent state of exciplex might occur. Such circumstance are similar to those observed when the ground state EDA complex is excited. The rate equation of these processes may be written as follows.

$$\frac{dE}{dt} = -aE - bE^2 + cE^* \quad (5)$$

$$\frac{dE^*}{dt} = \alpha bE^2 - cE^* \quad (6)$$

where E and E* represent, respectively, the concentrations of fluorescent and excited states of exciplex, c represents the rate constant of the radiationless transition from the excited state to the ground state of exciplex. a and b are the same quantity as given in eq. (1) and eq. (3), α is the quantum yield of the formation of the excited state of exciplex due to the diffusion-controlled collision of the exciplexes. Since eq. (3) can reproduce the experimental results quite satisfactorily, it may be argued that the effect of this E-E annihilation process on the fluorescence decay is very small. However, it may be possible also that the rate constants in eq. (3) contain implicitly the E-E annihilation effect. For a closer examination of this problem, it should be necessary to solve the coupled eq. (5) and (6) numerically, though we do not attempt it here.

In the case of anthracene-DMA heteroexcimer the higher excited state of exciplex can be produced also by the irradiation of both 347 nm and 694 nm pulses since the excited S_1-S_n absorption of heteroexcimer is observed in the region of 600~1000 nm.³ Thus, we can see whether the excitation of this exciplex affects its behavior significantly or not. Irradiating the solutions with 347 nm and 694 nm pulses, the observed decay curves of the exciplex were the same as those obtained with 347 nm irradiation only. Therefore the excited state of the exciplex produced by E-E anni-

hilation or successive two quantum absorption, seems to make a rapid internal conversion to its fluorescent state and no substantial effect specific to it seems to arise.

The higher excited state of s-tetracyanobenzene (TCNB)-benzene and TCNB-toluene complexes can always produced by the re-absorption of the CT fluorescence by the excited complex itself.⁴ The rate equations of these processes may be written as follows.

$$\frac{dE}{dt} = -aE - fE + cE^* \quad (7)$$

$$\frac{dE^*}{dt} = \alpha fE - cE^* \quad (8)$$

where f represents the rate constant of re-absorption, which is proportional to the CT fluorescence intensity, i.e., the concentration of the fluorescent state E . Thus, $f = b'E$ and the eq. (7) and eq. (8) reduced to eq. (5) and eq. (6). Thus the lifetime shortenings of these complexes through the re-absorption of the CT fluorescence can be expected. The problem on the higher excited state and interactions of exciplexes and of electron donor-acceptor complexes will be solved by progress of the laser experiments.

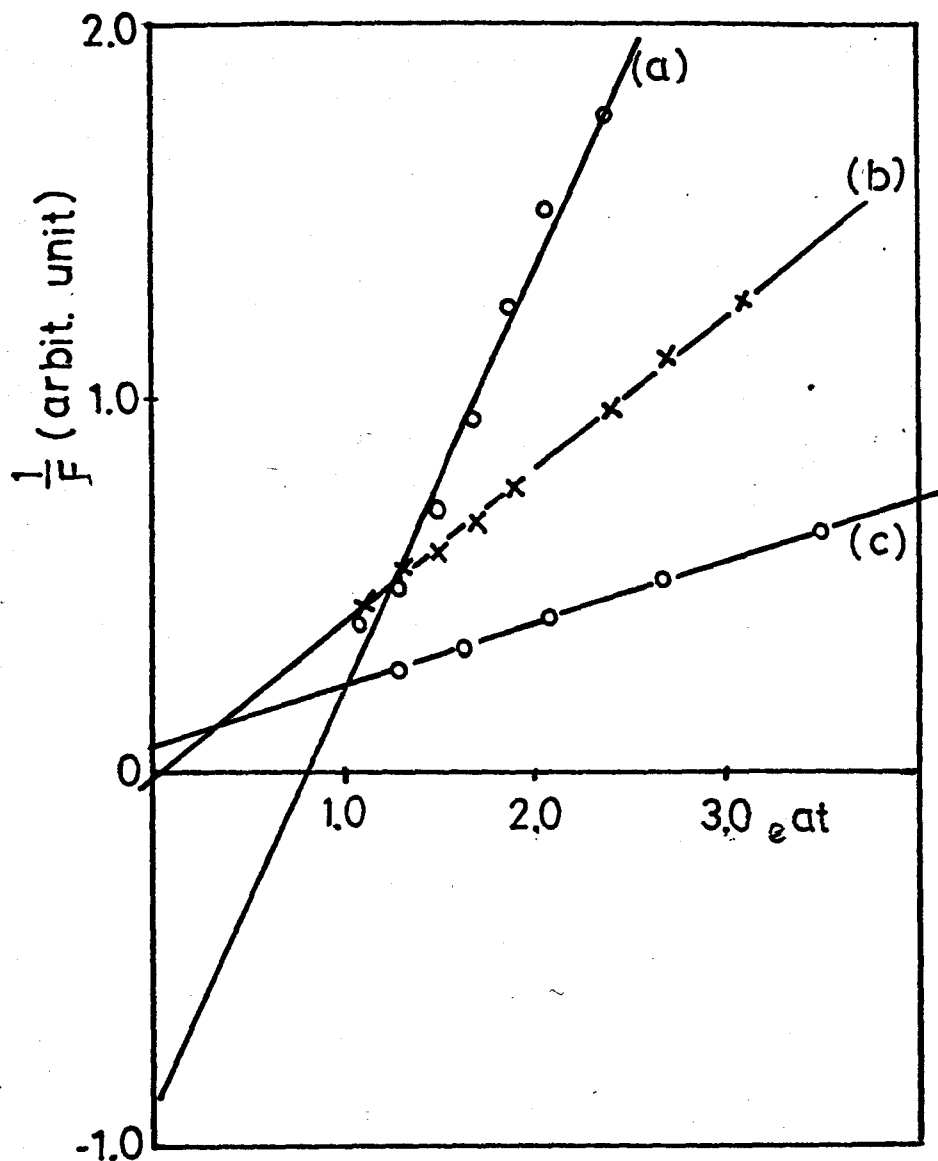

Fig. 1. Kinetic analysis on anthracene-DMA heteroexcimer

- (a) Anthracene 0.05M and DMA 2M in benzene, excited with focussed laser pulse.
- (b) Anthracene 0.05M and DMA 2M in benzene, excited with 0.3% intensity of the pulse.
- (c) Anthracene 5×10^{-4} M and DMA 10^{-1} M in ethylether, excited with normal intensity of laser.

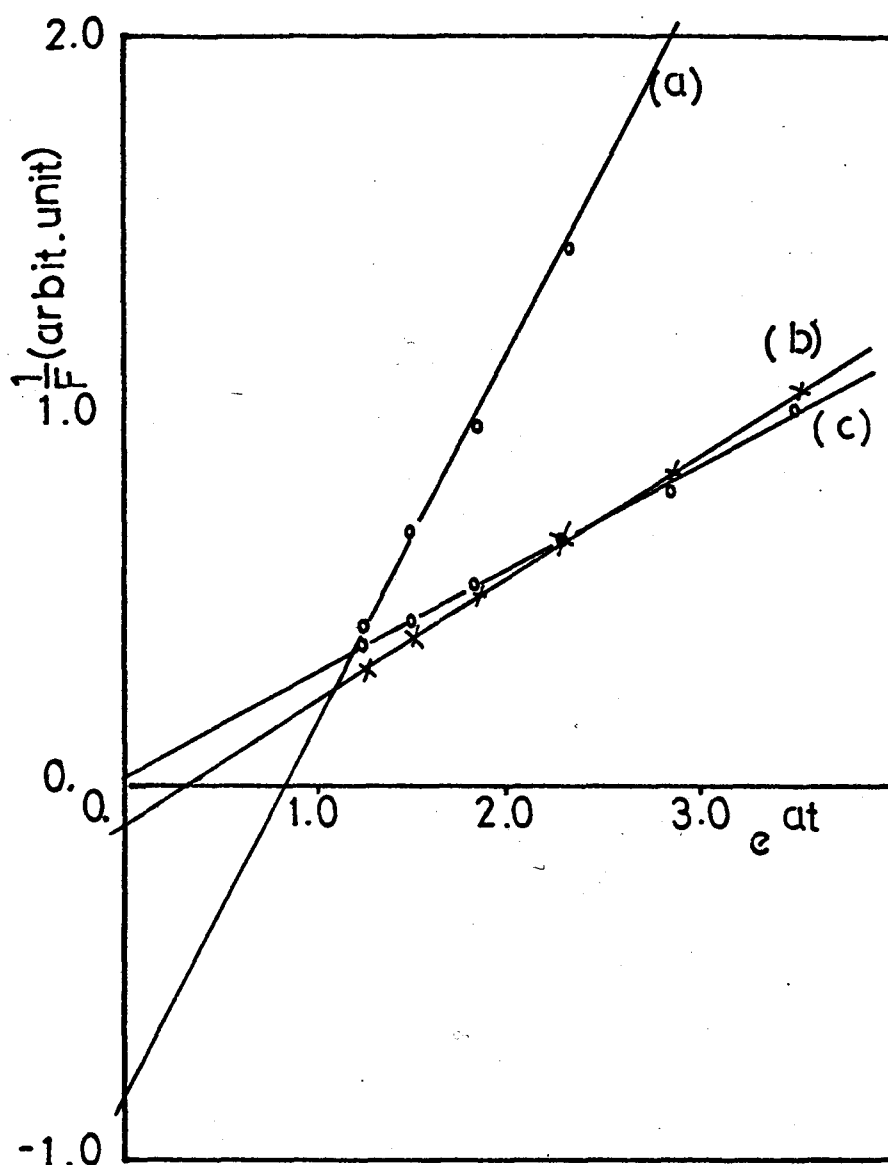

Fig. 2. Kinetic analysis on pyrene excimer

(a) Pyrene 0.25M in toluene, excited with focussed laser pulse.

(b) Pyrene 0.25M in toluene, excited with 0.3% intensity of the pulse.

(c) pyrene 10^{-2} M in cyclohexane, excited with normal intensity of laser.

REFERENCES

Chapter I

- (1) R.G.W.Norrish and G.Porter, Nature, 164, 658 (1949).
- (2) S.Glaesson, Ed., "Fast Reactions and Primary Processes in Chemical Kinetics," Nobel Symposium 5, Interscience Publishers, New York, 1967, p33, p81, p141, p263.
- (3) J.R.Novak and M.W.Windsor, Proc.Roy.Soc.A, 308, 95 (1968); J.Chem.Phys., 47, 3075 (1967); Science, N.Y., 161, 1342 (1968).
- (4) A.Müller, Naturforschung, 23a, 946 (1968).
A.Müller and E.Pflüger, Chem.Phys.Letters, 2, 155 (1968).
- (5) A.Müller and U.Sommer, Ber.Bunsenges.Physik.Chem., 73, 819 (1969).
- (6) Y.Nakato, N.Yamamoto, and H.Tsubomura, Chem.Phys.Letters, 1, 57 (1968), Observed by conventional flash photolysis method.
- (7) R.McNeil, J.T.Richards, and J.K.Thomas, J.Phys.Chem., 74, 2290 (1970).
- (8) R.Bonneau, J.Faure, and J.Joussot-Dubien, Chem.Phys.Letters, 2, 65 (1968).
- (9) D.S.Kliger and A.C.Albrecht, J.Chem.Phys., 50, 4109 (1969).
- (10) R.Bonneau, J.^oJussot-Dubien, and R.Besasson, ibid., 3, 353 (1969).
- (11) G.Porter and M.R.Topp, Proc.Roy.Soc.A, 315, 163 (1970).
- (12) C.R.Goldschmidt and G.Stein, Chem.Phys.Letters, 6, 299 (1970).
- (13) D.Huppert and K.H.Bar-Eli, J.Phys.Chem., 74, 3285 (1970).

- J.T.Richards, G.West, and J.K.Thomas, J.Phys.Chem., 74, 4137 (1970).
- (14) J.T.Richards and J.K.Thomas, Chem.Phys.Letters, 5, 527 (1970).
- (15) C.R.Goldschmidt and M.Ottolenghi, J.Phys.Chem., 74, 2041 (1970).
- (16) C.R.Goldschmidt and M.Ottolenghi, Chem.Phys.Letters, 4, 570 (1970).
- (17) H.Masuhara and N.Mataga, *ibid.*, 6, 608 (1970).
- (18) R.Potashnik and M.Ottolenghi, *ibid.*, 6, 525 (1970).

Chapter II

- (1) N.Mataga and Y.Murata, J.Am.Chem.Soc., 91, 3144 (1969).
- (2) S.Iwata, J.Tanaka, and S.Nagakura, J.Chem.Phys., 47, 2203 (1967).
- (3) H.Hayashi, S.Iwata, and S.Nagakura, *ibid.*, 50, 993 (1969).
- (4) N.Mataga, T.Okada, and K.Ezumi, Mol.Phys., 10, 201, 203 (1966).
- N.Mataga, T.Okada, and N.Yamamoto, Bull.Chem.Soc.Japan, 39, 2562 (1966).
- N.Mataga and K.Ezumi, *ibid.*, 40, 1355 (1967).
- N.Mataga, T.Okada, and N.Yamamoto, Chem.Phys.Letters, 1, 119 (1967).
- T.Okada, H.Matsui, H.Oohari, H.Matsumoto, and N.Mataga, J.Chem.Phys., 49, 4717 (1968).

- H. Leonhardt and A. Weller, Ber. Bunsenges. Physik. Chem., 67, 791 (1963).
- H. Knibbe, D. Rehm, and A. Weller, Z. Physik. Chem. (Frankfurt), 56, 95, 99 (1967).
- H. Beens, H. Knibbe, and A. Weller, J. Chem. Phys., 47, 1183 (1967).
- H. Knibbe, D. Rehm, and A. Weller, Ber. Bunsenges. Physik. Chem., 73, 839 (1970).
- (5) D. Rehm and A. Weller, Z. Physik. Chem. (Frankfurt), 69, 183 (1970).
H. Beens and A. Weller, Acta Phys. Polon., 34, 593 (1968).
- (6) T. Okada, H. Oohari, and N. Mataga, Bull. Chem. Soc. Japan, 43, 2750 (1970).
N. Mataga and O. Tanimoto, Theoret. Chim. Acta (Berl.), 15, 111 (1969).
D. Rehm and A. Weller, Ber. Bunsenges. Physik. Chem., 73, 834 (1970).
- (7) H. Masuhara, M. Shimada, and N. Mataga, Bull. Chem. Soc. Japan, 43, 3316 (1970).
- (8) R. Potashnik, C. R. Goldschmidt, and M. Ottolenghi, J. Phys. Chem., 73, 3170 (1969).
- (9) J. R. Novak and M. W. Windsor, Proc. Roy. Soc. A, 308, 95 (1968).
G. Porter and M. R. Topp, *ibid.*, 315, 163 (1970).
- (10) M. Sofue and S. Nagakura, Bull. Chem. Soc. Japan, 38, 1048 (1965).
- (11) Details of the measurements on the photocurrent will be published shortly by Taniguchi and Mataga.
- (12) H. Masuhara and N. Mataga, Chem. Phys. Letters, 6, 608 (1970).
- (13) Details of the estimation of the re-absorption effect and the supplemental experiments will be published shortly.

- (14) Th.Förster, "Fluoreszenz Organischer Verbindungen," Vandenhoeck and Ruprecht, Göttingen, 1951, p35.
- (15) K.Egawa, N.Nakajima, N.Mataga, and C.Yamanaka, Chem.Phys. Letters (in press).
- (16) H.M.Rosenberg and E.C.Eimuits, J.Phys.Chem., 70, 3494 (1966).
- (17) J.Czekalla and K.O.Mayer, Z.Physik.Chem.(Frankfurt), 27, 185 (1961).
- (18) T.Kobayashi, Y.Yoshihara, and S.Nagakura, The Symposium on EDA Complexes (Osaka), 1970, Preprint.
- (19) R.Potashnik and M.Ottolenghi, Chem.Phys.Letters, 6, 525 (1970).
- (20) C.R.Goldschmidt and M.Ottolenghi, *ibid.*, 4, 570 (1970).
- (21) S.Iwata, J.Tanaka, and S.Nagakura, J.Am.Chem.Soc., 88, 894 (1966).
- (22) H.Masuhara, M.Okuda, and M.Koizumi, Bull.Chem.Soc.Japan, 44, 38 (1971).
- (23) A.Ishitani and S.Nagakura, Theoret.Chim.Acta (Berl.), 4, 236, (1966).
- (24) T.Shida and H.Hamill, J.Chem.Phys., 44, 2375 (1966).
- (25) The authors acknowledge the assistance of Mr. N.Tsujino for calculating the overlap integrals and intermolecular electrostatic interaction terms.
- (26) R.S.Mulliken, C.A.Rieke, D.Orloff, and H.Orloff, J.Chem.Phys., 17, 1248 (1949).
- (27) G.Briegleb, J.Trencsényi, and W.Herre, Chem.Phys.Letters, 3,

146 (1969).

(28) H.Masuhara, M.Shimada, and N.Mataga, to be published.

Chapter III

(1) R.S.Mulliken and W.B.Person, "Molecular Complexes," Wiley-Interscience, New York, 1969.

(2) H.Masuhara and N.Mataga, to be published. Detail description and confirmation are included in Chapter II of the present thesis.

(3) N.Mataga and Y.Murata, J.Am.Chem.Soc., 91, 3144 (1969).

(4) H.Masuhara, M.Shimada, and N.Mataga, Bull.Chem.Soc.Japan, 43, 3316 (1970).

(5) T.Okada, H.Oohari, and N.Mataga, *ibid.*, 43, 2750 (1970).

H.Leonhardt and A.Weller, Ber.Bunsenges.Physik.Chem., 67, 791 (1963).

H.Knibbe, D.Rehm, and A.Weller, *ibid.*, 72, 257 (1968).

O.D.Dmitrieffsky and A.N.Terenin, Doklady Akad. Nauk SSSR, 151, 122 (1963).

M.Koizumi and H.Yamashita, Z.Physik.Chem.(Frankfurt), 57, 103 (1968).

K.Kawai, N.Yamamoto, and H.Tsubomura, Bull.Chem.Soc.Japan, 42, 369 (1969).

(6) F.S.Stewart and M.Eisner, Mol.Phys., 12, 173 (1967).

D.F.Ilten and M.Calvin, J.Chem.Phys., 42, 3760 (1965).

- E.M.Kosower and L.Lindquist, *Tetrahedron Letters*, 50, 4481 (1965).
- R.F.Cozzes and T.A.Cover, *J.Phys.Chem.*, 74, 3003 (1970).
- W.C.Meyer, *ibid.*, 74, 2118 (1970).
- (7) R.Potashnik, C.R.Goldschmidt, and M.Ottolenghi, *ibid.*, 73, 3170 (1969).
- (8) J.Millman and H.Taub, "Pulse and Digital Circuits," McGraw-Hill, New York, 1966, p187.
- (9) Y.Taniguchi and N.Mataga, to be published.
- (10) M.Sofue and S.Nagakura, *Bull.Chem.Soc.Japan*, 38, 1048 (1965).
A.Ishitani and S.Nagakura, *Theoret.Chim.Acta (Berl.)*, 4, 236 (1966).
- (11) T.Shida and H.Hamill, *J.Chem.Phys.*, 44, 2375 (1966).
- (12) G.Porter and M.R.Topp, *Proc.Roy.Soc.A*, 315, 163 (1970).
- (13) Ni electrodes dissolved under high electric field. The dark current is larger than the laser-induced transient photocurrent.
- (14) G.E.Johnson and A.C.Albrecht, *J.Chem.Phys.*, 44, 3179 (1966).
T.Imura, N.Yamamoto, and H.Tsubomura, *Bull.Chem.Soc.Japan*, 43, 1670 (1970).
- (15) This excitation light intensity effect on ionic dissociation was examined under rather low concentration. In the case of the high concentration of TCNB complexes (O.D. at 347 nm ~ 1.0), the saturation effect of the photocurrent induced by high intensity laser excitation was observed. This problem is now

investigated upon.

- (16) T.Kobayashi, Y.Yoshinara, and S.Nagakura, The Symposium on EDA Complexes (Osaka), 1970, Preprint.

Chapter IV

- (1) C.R.Goldschmidt, Y.T.Tomkiewics, and I.B.Berlman, Chem.Phys. Letters, 2, 520, 536 (1968).
- (2) H.Masuhara and N.Mataga, *ibid.*, 7, 417 (1970).
- (3) C.R.Goldschmidt and M.Ottolenghi, *ibid.*, 4, 570 (1970).
- (4) H.Masuhara and N.Mataga, *ibid.*, 6, 608 (1970).

ACKNOWLEDGEMENTS

The author wishes to express his sincere thanks to Prof. N.Mataga for his kind guidance. Thanks are also given to Mr. M.Shimada and Mr. N.Tsujino for their assistance in the experimental works. The author is indebted to all members of his laboratory, particularly to Mr. T.Okada.