

Title	Roles of Interactions between the Red Blood Cell Membrane, Plasma Proteins and Electrolytes in the Regulation of Red Blood Cell Deformability
Author(s)	Kikuchi, Yuji
Citation	大阪大学, 1982, 博士論文
Version Type	VoR
URL	https://hdl.handle.net/11094/24333
rights	
Note	

Osaka University Knowledge Archive : OUKA

<https://ir.library.osaka-u.ac.jp/>

Osaka University

Roles of Interactions between the Red Blood Cell
Membrane, Plasma Proteins and Electrolytes in
the Regulation of Red Blood Cell Deformability

by

Yuji KIKUCHI

Division of Physiology
Research Institute of Applied Electricity
Hokkaido University
Sapporo, Japan

ABSTRACT

Nucleopore filter method was improved to investigate the deformability of red blood cells (RBCs). The method gives an average passage time for single RBCs through 5 μm pores in the filter as an index of the deformability. The deformability of RBCs in fresh human blood was studied under varying concentrations of electrolytes and proteins in the plasma. RBC deformability was improved as the protein concentration in the medium was reduced. Further, effect of hyperosmolarity on RBC deformability was found to be much dependent on the protein concentration. RBC deformability was reduced with increasing osmolarity above 320 mOsmol when the protein concentration was normal, however it remained constant up to 370 and 430 mOsmol when the protein concentration was lowered to 1/3 and 1/6 of normal, respectively.

The interactions between the red cell membrane, plasma proteins and electrolytes were studied in another series of experiments. An increase in the adsorption of plasma proteins to the red cell surfaces was observed with an increment in the ionic strength of the medium induced by an addition of NaCl. The following succession of events was assumed to interpret these results. An electric repulsive force between RBCs and plasma proteins is weakened by an increased Na^+ ion concentration. This reduction in the repulsive force increases the adsorption of proteins to the surfaces of RBCs. The adsorbed proteins will restrict the red cell membrane flexibility, causing

a reduction in RBC deformability. Furthermore, results were obtained showing that the adsorbed proteins prevent a deterioration of RBC deformability with time and that K^+ ions have no effect to increase the adsorption of proteins to the red cell membrane contrary to Na^+ ions. It was suggested that Na^+ and K^+ ions may play an important role in controlling the adsorption of proteins to the red cell membrane, i.e. in the regulation of the deformability of RBCs and in maintaining the red cell membrane functions.

CONTENTS

1. Introduction	1
2. Blood Composition	9
3. Methods	
a) RBC deformability	15
b) Hematocrit	33
c) Ionic osmolarity	34
d) Total protein concentration	34
e) Colloid osmotic pressure	34
f) Distribution of radio-isotope labeled human serum albumin	35
4. Sample Preparations	36
5. Experimental Results	39
6. Discussion	54
7. Roles of Na^+ and K^+ ions in the red cell membrane functions	
a) Role of the protein adsorption in RBC passage through a 3 μm pore	69
b) Roles of Na^+ and K^+ ions in controlling the adsorption of proteins to the red cell membrane	73
8. Appendix	
a) Electric diffuse double layer around a red blood cell	80
b) van der Waals interaction	83
References	87
Acknowledgements	92

1. INTRODUCTION

Mammalian red blood cells (RBCs) take the well-known biconcave disc shape under the static equilibrium conditions. This shape of RBCs is remarkably regular and preserved even when the interior contents are lost by hemolysis, suggesting that the biconcave shape is maintained by the red cell membrane structure and elasticity. On the other hand, a number of evidences have shown that RBCs are extremely deformable. RBCs take various odd shapes in the flowing blood in response to mechanical stresses acting on them. This deformable character of RBCs has been discussed to be of critical importance for blood flow through microvessels. The diameters of mammalian capillary vessels range from 10 μm down to 3 μm , mostly smaller than that of an unstressed RBC (about 8 μm for human and 6-8 μm for different species of mammals). The relationship between RBC and capillary dimensions is not constant but varies for different organs depending on the importance of roles of RBCs in their physiologic functions. The capillary diameters are relatively small in the organs where RBCs play significant roles in their functions, while they are relatively large in those where the roles of RBCs are less significant. For example, in muscles, where the nutritive function of the capillary beds is crucial for the muscle contractile ability, the mean diameter of capillaries is 25-45 % smaller than that of RBCs (Sobin and Tremer, 1977). RBCs must deform considerably in order to pass through those vessels; the

deformability of RBCs becomes a determinant factor for the blood flow through such fine capillaries. The least diameters of capillaries are found in the spleen, whose function is to remove aged RBCs from the circulating blood. The selective trapping of aged RBCs in the spleen is thought to be due to their reduced deformability compared to that of the younger cells. Thus, the deformability of RBCs plays critical roles in the nutritating function of capillary blood flow and in maintaining the RBC population in the circulating blood.

Both the regular shape and high deformability of RBCs are related to the elastic properties of the red cell membrane. Fung (1966) showed that the biconcave shape of RBCs allows an infinite variety of shape deformations without accompanying changes in the surface area and volume. The importance of the cell geometry for the deformability has been confirmed by the observations that the stiffness of the red cell membrane against areal stretching is much larger than that against uniaxial stretching. The first estimate of the elastic modulus of the red cell membrane was given by Katchalsky et al. (1960) based on the sphering phenomenon of RBCs in a hypotonic solution. RBCs swell due to the inflow of water to be finally spheres as the osmolarity of the surrounding medium is reduced. This sphering of RBCs proceeds without changing the surface area; when the stretching of the surface area exceeds 7 %, the cell membrane ruptures. The estimated value of the elastic modulus is 3.1×10^7 dynes/cm² (corrected by Skalak et al., 1973).

Rand and Burton (1964) confirmed the range of this estimate by the experiment using glass micropipettes. A part of the red cell membrane was sucked into a micropipette with nearly 2 μm diameter; the hemispherical deformation of the membrane in the pipette and the applied negative pressure were analyzed using the Laplace relation. Their estimates ranged from 7.3×10^6 to 3.0×10^8 dynes/cm². Hochmuth and Mohandas (1972) observed the elongation of RBCs adhering to a glass surface under the stream of the suspending fluid. Their estimation, however, yielded much lower values of the order of 10^4 dynes/cm² for the elastic modulus. Further, Hoeber and Hochmuth (1970) obtained a value 7.2×10^5 dynes/cm² by analyzing the time course of recovery of deformed RBCs to their unstressed shape. The stiffness of the red cell membrane seemed to vary greatly depending on how it was stressed. It has been considered that the highest and lowest estimates corresponded to the elastic moduli against areal and uniaxial stretchings, respectively. RBCs are deformed complicatedly in the capillaries because the deformations are restricted in diameter, but general features of the capillary passability of RBCs are consistent with the above observations. When the diameter of a capillary is so small that RBCs cannot pass without deformations accompanying the surface area stretching, the passability of RBCs is strictly restricted or hemolysis occurs during the passage (Gregersen et al., 1967; Chien et al., 1971).

Since the red cell contains the concentrated hemoglobin

solution of about 30 g/dl, the viscosity of the hemoglobin solution is supposed to affect the deformability. Dintenfass (1968) estimated the internal viscosity of RBCs to be within the range of 1 to 6 cP. Cokelet and Meiselman (1968) obtained a value of about 6 cP from measurements on the hemoglobin solutions with concentrations around 30 g/dl. These values are unexpectedly low and the internal viscosity seems to be too low to affect the deformations of RBCs with observed speeds. However, it has been known that deoxygenated hemoglobin molecules in sickle RBCs are crystalized within the cells to affect not only the deformability but even the shape of the cells. The pronouncedly reduced deformability of sickle RBCs due to the crystalization of the hemoglobin molecules causes serious illness and anemia. Therefore, the internal viscosity may possibly become important when hemoglobin molecules or their solubility are modified under some pathological conditions.

These three basic factors; 1) cell geometry, 2) cell membrane elasticity and 3) internal viscosity; would be in close relations with each other in determining the cellular deformability. Further, the regulation mechanisms of these basic properties would involve much more intra- and extracellular factors. It has been shown that the deformability of RBCs changes under various internal and external conditions. A reduced deformability has been observed in aged RBCs (Shiga et al., 1979). A decrease in the deformability occurs in hyperosmotic media (Schmid-Schönbein et al., 1969). The depletion of ATP in aRBC causes a reduction in the deformability

(Weed et al., 1969) and alterations in the cell shape (Nakao, 1974). Impaired deformability of RBCs in several severe diseases and its amelioration by some drugs have been reported by several researchers (Dintenfass, 1977; Ehrly, 1978; Tsushima et al., 1980; Kikuchi et al., 1980, 1981). These findings suggest that the mechanical properties of the cell membrane and interior contents of a RBC are closely related with the cellular chemical or metabolic states. Problems in these aspects of RBC deformability are now extensively studied and providing new knowledges important not only in physiology of the microcirculation but also from general points of view of functions of the biological membrane and cellular phenomena.

In the present study a simple but reliable method for the deformability measurement has been developed and applied to human RBCs in fresh whole blood to show an important role of the interactions between the red cell membrane, plasma proteins and electrolytes in the regulation of RBC deformability. The passage of RBCs through pores of 5 μ m diameter in the Nuclepore membrane filter was studied under varying concentrations of plasma proteins and electrolytes in the suspending fluid media.

A reduction in RBC deformability under hyperosmotic conditions has been reported by several investigators but there remains a discrepancy with respect to the extent of the reduction in RBC deformability. Schlick and Schmid-Schönbein (1975) reported that the micropore passability of RBCs suspended in saline remained almost unaffected under the osmotic pressure in the range of 200 to 600

mOsmol, while Ehrly (1978) noted that the whole blood passage through a Millipore filter was much impeded by an increment in osmotic pressure from normal 300 mOsmol to 400 mOsmol. Further, Schmid-Schönbein et al. (1969) observed different extents of reduction in the flow rate of RBC suspensions through Millipore filters of different pore sizes; the flow rate through 5 μ m pores was not much affected up to 400 mOsmol, whereas the one through 8 μ m pores was much reduced. The present study seems to provide a new explanation of the discrepancy; the effect of hyperosmolarity on the deformability of RBCs strongly depends on the plasma protein concentration in the suspending media. This aspect further indicates the importance of the RBC-plasma protein interactions for the deformability of RBCs.

In order to study the interactions between RBCs and plasma proteins, measurements were carried out on the total protein concentration (T.P.) and colloid osmotic pressure (COP) of plasma and on the distribution of ^{131}I human serum albumin between RBCs and plasma. An increase in the adsorption of plasma proteins to the red cell surfaces was observed with increasing ionic strength of the suspending medium. It was shown that the reduction in the deformability of RBCs exposed to hyperosmolarity may be caused by the increased amount of adsorbed proteins which would restrict the red cell membrane flexibility. The amount of proteins adsorbed to RBCs, which was estimated to be close on the number which can form a single layer of proteins covering the whole surface of a red cell

under normal protein and electrolyte concentrations in the plasma, seemed to be doubled under 450 mOsmol. The passability of RBCs through 5 μ m pores was improved as the amount of adsorbed proteins was reduced by lowering the protein concentration in the medium.

Protective effects of albumin on the shape and fragility of RBCs have been reported by several investigators. Albumin maintains the biconcave shape of RBCs, restores the normal shape of RBCs deformed by repeated washing with saline (Ponder, 1971) and protects RBCs from osmotic and mechanical destructions (Katchalsky et al., 1960; Williams, 1973). This aspect of the RBC-plasma protein interactions was confirmed in the experiment using 3 μ m pores; the passability of RBCs was often impaired immediately and decreased quickly with time when RBCs were suspended in saline. The changes in the red cell membrane structures would be more sensitively reflected in the passability of RBCs through 3 μ m pores, since the red cell membrane is forced to deform to a much greater extent compared to the case of 5 μ m pores.

Furthermore, an interesting result was obtained concerning with the specificity of ions. No increase in the adsorption of plasma proteins to the red cell surfaces was observed under comparative osmotic pressures when the osmolarity of plasma was elevated by adding KCl instead of NaCl. It is suggested that the distributions of Na^+ and K^+ ions between the outside and inside of a red blood cell may play an important role in controlling the adsorption of plasma proteins, which has been shown to influence the functions

and mechanical properties of the red cell membrane.

A brief description of the blood composition is given in Sect. 2 as a background for the material in the present study. The method for the deformability measurement, which has been developed by the present author, is described rather precisely in Sect. 3. The present study seems to have owed to the performance of this method, which enables reliable measurements in a short time using fresh blood samples. Sample preparations, experimental results and discussions are given in Sect. 4, 5 and 6, respectively. The roles of Na^+ and K^+ ions in the red cell membrane functions are considered based on the present experimental results in Sect. 7. Some experimental results are given in Sect. 6 and 7 for making up the discussions. Calculations of the electric potential around a RBC and the van der Waals interaction between a RBC and a plasma protein are given in Appendix.

2. BLOOD COMPOSITION

Blood is a suspension of blood cells in the plasma. Plasma itself is an aqueous solution of a numerous number of low molecular weight inorganic and organic materials and proteins. The blood cells and main solutes in plasma are listed in Tables 1 and 2, respectively. Most of the blood cells are RBCs, whose volume % in blood, called "hematocrit", ranges from 40 to 45 % normally, while all the other cells amount to less than 1 %. Therefore, from a point of mechanical view, the blood can be regarded as a suspension of RBCs in plasma.

The osmolarity of plasma is determined mainly by sodium and chloride ions, being in the range of 280 to 300 mOsmol. The total protein concentration ranges from 6 to 8 g/dl, which gives the colloid osmotic pressure from 20 to 30 mmHg.

The dimensions and composition of the red cell are shown in Fig. 2-1 and Table 3, respectively. RBCs are formed in the bone marrow and released in the circulating blood after matured in it. An immature RBC possesses a nucleus, which is shed during the maturation. RBCs circulate for about 120 days and aged RBCs are destroyed in the spleen. Despite the lack of a nucleus and mitochondria, RBCs are metabolically active. The cell membrane possesses $\text{Na}^+ - \text{K}^+$ exchange pumps, which pump Na^+ out and K^+ in against electro-chemical potential gradients using energy produced from the glucose metabolization.

Most of white cells are bigger than RBCs and their deformability is thought to be less than that of RBCs. Therefore, white cells may block the capillary vessels transiently, causing an interference to the blood flow through the microcirculation. However, the interfering effect is usually negligible because of the small number of white cells (1-2 per 1000 RBCs). Platelets are more numerous than white cells (50-100 per 1000 RBCs), but their influence to the mechanical properties of blood is also negligible because of the small size. Both white cells and platelets become important under pathological conditions.

Plasma is a Newtonian fluid with viscosity 1.2 cP at 37° C. Whole blood shows a strong non-Newtonian behavior; the viscosity decreases markedly with increasing shear rate. It has been shown that the steep increase in the viscosity at low shear rates below 1 sec^{-1} is caused by the progressive aggregation of RBCs and that the gradual decrease at high shear rates by the deformation of RBCs.

Cell	Number/mm ³	Unstressed shape and dimensions (μm)	Volume % in blood
Red blood cell (Erythrocyte)	4-6 x 10 ⁶	Biconcave disc 8 x 1-3	45
White blood cells (Leucocytes)			
Total	4-11 x 10 ³		
Granulocytes			
Neutrophils	1.5-7.5 x 10 ³] Roughly spherical 7-22	1
Eosinophil	0-4 x 10 ²		
Basophil	0-2 x 10 ²		
Lymphocytes	1-4.5 x 10 ³		
Monocytes	0-8 x 10 ²		
Platelets	250-500 x 10 ³	Rounded or oval 2-4	

Table 1. Cells in blood (Caro et al., 1978)

Material	Concentration (g/100 ml)	Molecular weight $\times 10^{-3}$	Molecular dimensions (nm)
Water	90-92		
Proteins			
Serum albumin	3.3-4.0	66	15x4
α_1 globulins	0.31-0.32	44-200	
α_2 globulins	0.48-0.52	150-300	
β globulins	0.78-0.81	90-1300	20-50
γ globulins	0.66-0.74	160-320	23x4
Fibrinogen	0.34-0.43	400	50-60x3-8
Inorganic constituents			
Cations			
Sodium	0.31-0.34		
Potassium	0.016-0.021		
Calcium	0.009-0.011		
Magnesium	0.002-0.003		
Anions			
Chloride	0.36-0.39		
Bicarbonate	0.20-0.24		
Phosphate	0.003-0.004		

Table 2. Outline of composition of plasma (Caro et al., 1978)

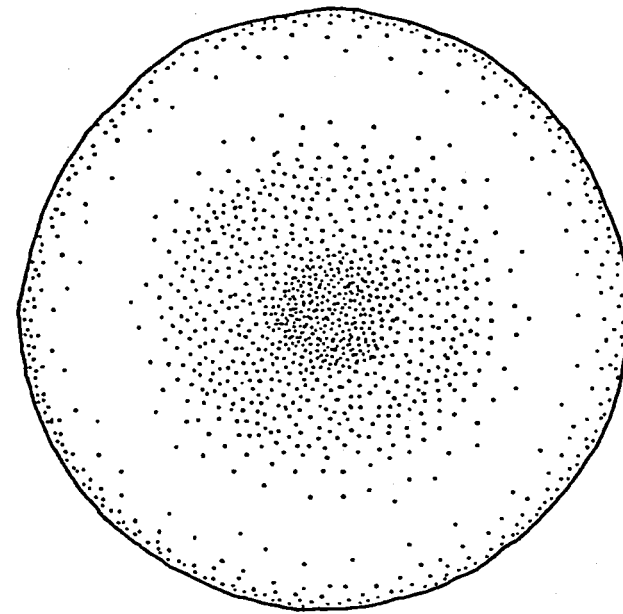

7.82±0.62 μm

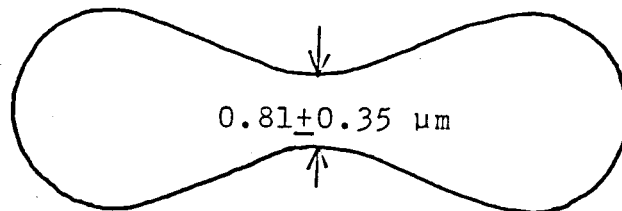

0.81±0.35 μm

2.58±0.27 μm

Volume = 94±14 μm^3

Surface area = 135±16 μm^2

Fig. 2-1. Diagram of an unstressed red blood cell (Fung, 1977)

	Percentage of mass
Water	65
Membrane components (protein, phospholipid, cholesterol)	3
Hemoglobin	32
Inorganic:	
Potassium	0.420g/100 ml
Sodium	0.025g/100 ml
Magnesium	0.006g/100 ml
Calcium	small amount

Table 3. Composition of the red cell (Caro et al., 1978)

3. METHODS

a) RBC deformability

a-1) Introductory remarks to the RBC deformability measurement

Several investigators have made great efforts to quantify the deformability of RBCs as definitely as possible to analyze it based on the mechanical properties of the red cell membrane and intracellular contents (Rand and Burton, 1964; Hoerber and Hochmuth, 1970; Hochmuth and Mohandas, 1972; Bessis and Mohandas, 1975; Bull and Brailsford, 1975). Their methods, however, require troublesome procedures and a long time for measurement and further involve artificial modifications of blood samples. Largely scattering values reported in their studies seem to have been caused probably by the time wasting and highly artificial procedures of the methods. As described in Sect. 1, RBC deformability changes with time depending on the cellular metabolic states and is strongly influenced by the composition of the surrounding plasma. Further, only to wash RBCs with saline often causes an impairment in the deformability. These results indicate that RBC deformability should be measured on whole blood in a short time after the sampling if informations relevant to in-vivo conditions are to be obtained. However, available methods which are suitable for whole blood are restricted to qualitative measurements. For the study of changes in RBC deformability under different environmental conditions and of the regulation mechanisms of RBC deformability, methods are required which can give

quantitative results with an accuracy within 10 % in a short time using whole blood.

a-2) Development of the present method

The present method satisfies the above requirements to some extent. It is based on the filtration method which was initiated by Teitel (1965). Gregersen et al. (1967) used newly developed Nuclepore membrane filters, which have straight cylindrical pores of constant defined diameters, to quantify RBC deformability by passability of a RBC through a pore using pore size of 2-3 μm . Reid et al. (1976) constructed a simple apparatus for the Nuclepore membrane filter method and applied it to the use of whole blood; volume flow rate through a filter with 5 μm pores under 20 cmH_2O pressure difference was taken as an index of RBC deformability. Because of its simplicity, the method of Reid et al. has been used by many researchers. However, their measurements showed a large scattering in the healthy subjects and a simple calculation of the blood passage time through the 5 μm pore and the driving pressure showed a large discrepancy from the values expected for the blood flow in capillary blood vessels in-vivo (Kikuchi et al., 1979). A lack of consistency was experienced also in our trials using an apparatus constructed according to their description.

Such experiences motivated the author to examine the Nuclepore filter method. It became clear that air bubbles adhering to the filter had caused largely different blood flow rates in serial

measurements. A technique which enables complete removal of air bubbles from the filter improved the reproducibility to a great extent and at the same time increased the volume flow rate of whole blood by more than ten times (Kikuchi et al., 1979). Further, the improved reliability made clear that the flow rate of blood through the filter is dependent on the hematocrit; consequently flow rate alone is an insufficient measure of RBC deformability. A simple analysis of the observed dependence on hematocrit made it possible to estimate an average passage time for single RBCs through pores of 5 μm in diameter and 10 μm in length (Kikuchi et al., 1980). This quantity is more suitable as an index of RBC deformability. In addition, some technical improvements of the original apparatus has been made for a routine use. A washing system was added and electrically-operated valves were fully installed. It has become possible to repeat measurements at three minute intervals with an accuracy within 5 %. This improved filtration method has shown its usefulness in a basic study of RBC deformability (Kikuchi and Koyama, 1981) and in clinical applications (Kikuchi et al., 1980, 1981).

a-3) Apparatus and operations

A diagram of the apparatus is shown in Fig. 3-1. The electric circuit to control the solenoid valves is given in Fig. 3-2. Blood is introduced into the 0.5 ml graduated cylinder (S), which is connected to the inlet of the filter holder (H), up to a level about 0.1 ml above the top graduation. The blood is made to flow through

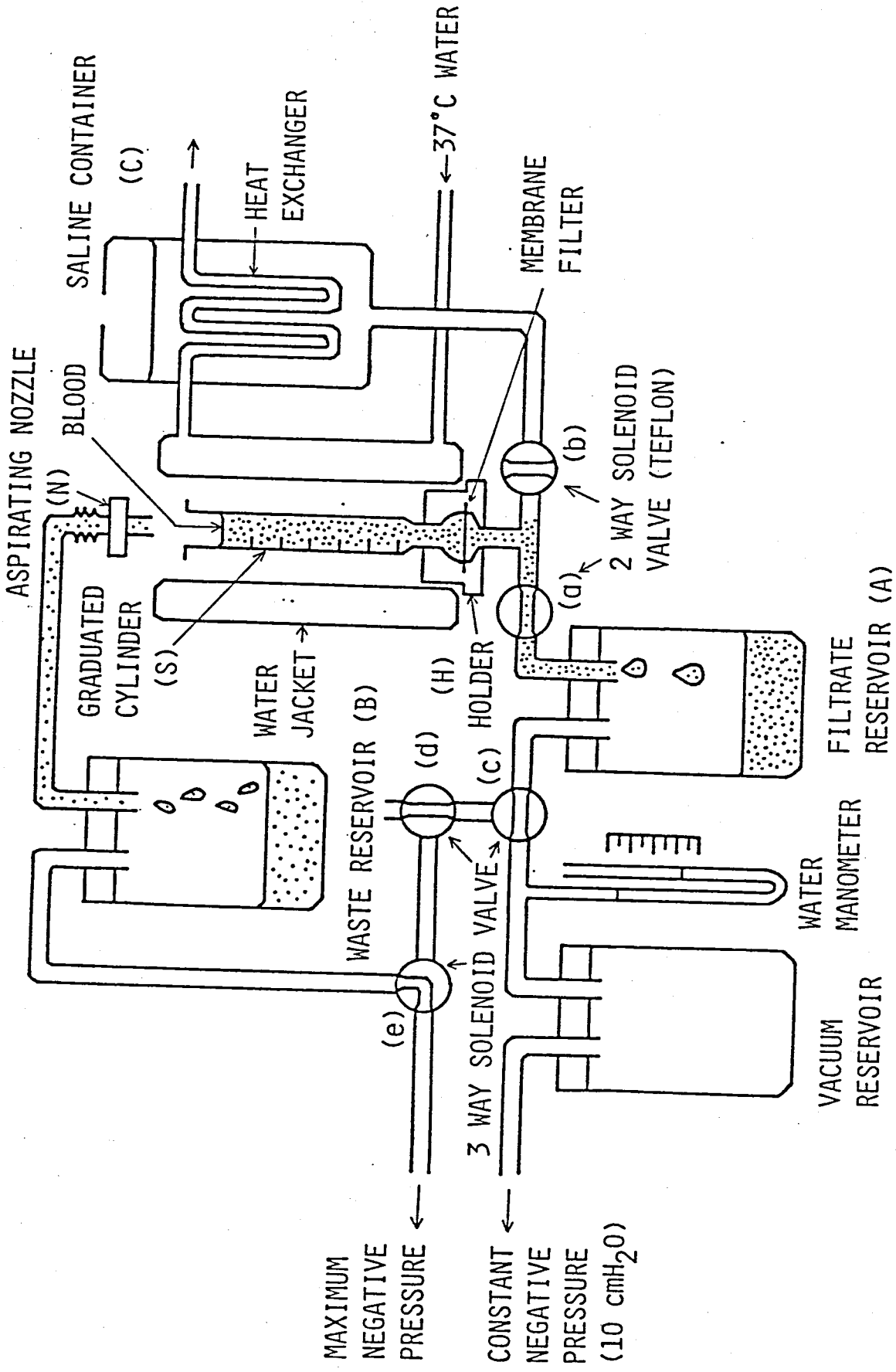

Fig. 3-1. Diagram of the apparatus for the deformability measurement

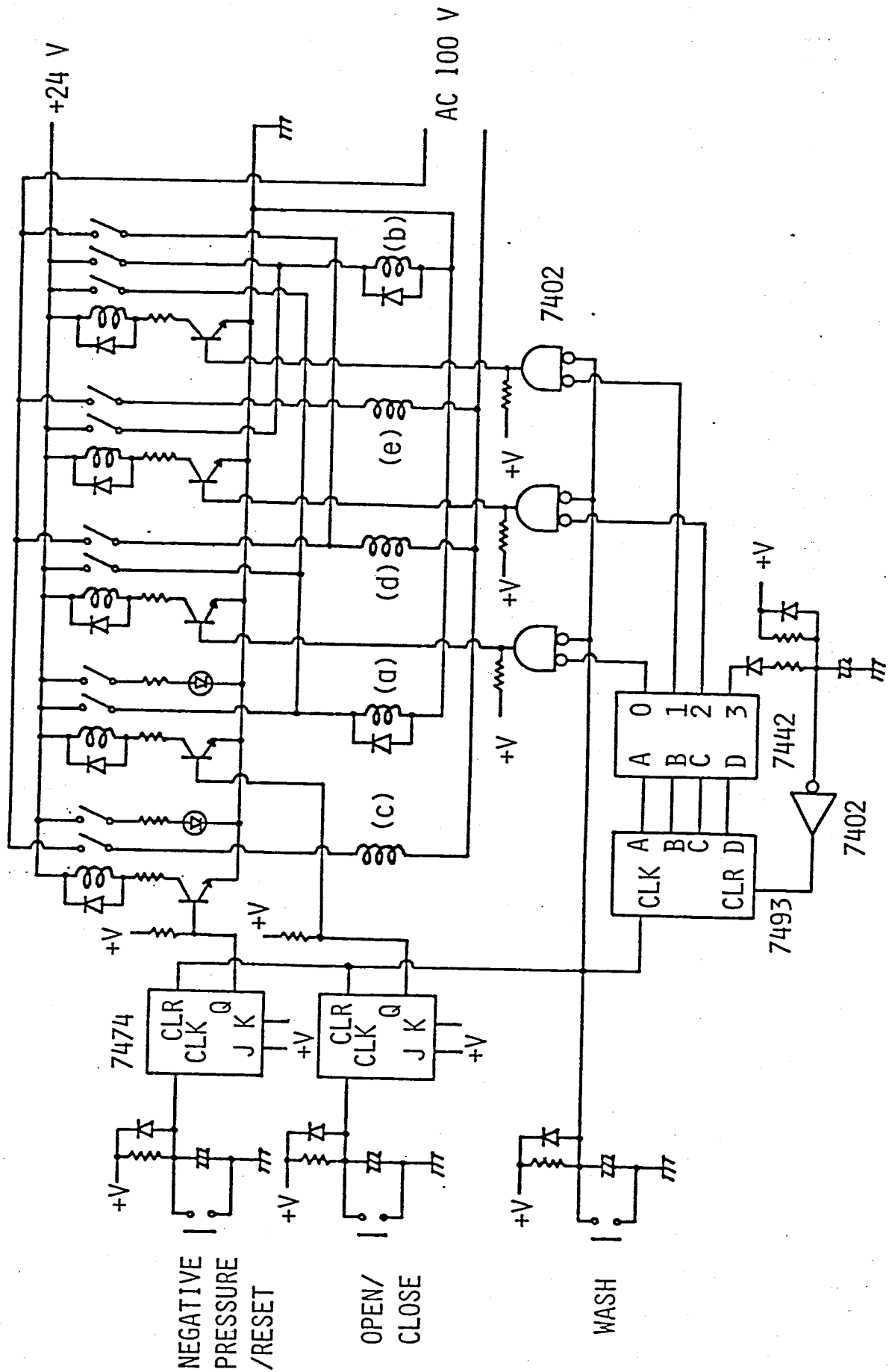

Fig. 3-2. Electric circuit to control the solenoid valves in the apparatus

the filter by applying 10 cmH₂O negative pressure in the bottle (A), which is a filtrate reservoir, and opening the valve (a). The moments when the upper surface of the blood crosses every 0.05 ml graduation from 0.5 to 0 ml graduation are timed by an electronic timer. The times are printed out or stored in IC memories and used for the estimation of a mean pore passage time of single RBCs described below. Complete removal of air bubbles from the filter is essential for reproducible measurements. To accomplish this, saline is rapidly drawn from the bottle (C), which is a saline container, through the filter into the bottle (B), which is a waste reservoir, by applying strong negative pressure in (B) and connecting the aspirating nozzle (N) to the inlet of the graduated cylinder (S). The upward stream of saline takes away any air bubbles trapped in the pores of the filter. The aspirator (Yamato Scientific Co., LTD., WP-45) provides two levels of negative pressure; one adjusted to 10 cmH₂O by a leak valve for the measurement and the other maximum negative pressure for making rapid stream of saline. Saline which fills the graduated cylinder (S) when the suction is stopped is made to flow through the filter by applying 10 cmH₂O negative pressure in (A) and opening (a), i.e. the same pressure difference for the blood measurement. The time for 0.5 ml of saline to flow is measured by the timer in order to check the filtering property of the filter, i.e. proper pore density and tight package in the holder. Then saline is again strongly sucked into (S) from (C). The saline filling (S) is drained this time by opening (a) without applying

negative pressure. Valve (a) is closed when the top surface of the saline comes to the zero graduation in (S). A blood sample is gently introduced onto the small quantity of saline remaining at the bottom of (S). As the filter is not exposed to air, no more air bubbles remain adhering to the filter. After the blood is drawn for measurement, the graduated cylinder and the blood flow path are flashed with saline. By applying the maximum negative pressure in (A) and opening the valves (a) and (b), saline is rapidly drawn from (C) into (A) to clean the path beneath the filter holder. Saline can also flow rapidly upward or downward through the graduated cylinder, filter and holder to clean them. Each process of washing and removing air bubbles can be done automatically by pressing one button on the control panel. Although a used filter can be cleaned and similar results may be obtained with a cleaned filter, a new filter was used for every measurement to increase reliability.

a-4) Flow characteristics of whole blood

The flow rate of blood is not constant but decreases slightly during the passage through the filter since the actual pressure difference, which exceeds the applied one by the weight of blood sample in (S), is reduced as the blood sample is drawn. The correction for this change in pressure difference is easily made by multiplying the observed flow rate, which is determined for every 0.05 ml sample volume, by $(\Delta P_0 + \rho gh_0)/(\Delta P_0 + \rho gh)$ or $(\Delta P_0 + \rho gh)/\Delta P_0$,

where h is the corresponding height of blood sample in (S) from the 0 graduation; h_0 , length from 0 to 0.5 ml graduation; ΔP_0 , pressure difference when $h=0$; ρ , specific gravity; g , acceleration of gravity. The flow rate is corrected to the one for the initial ($h=h_0$) or final ($h=0$) pressure difference, respectively. Examples of corrected and uncorrected flow curves are shown in Fig. 3-3. The corrected ones are almost linear as expected.

Since whole blood contains less deformable white cells, it is necessary to consider their effect on the blood flow through the filter; the pores in the filter might be blocked by white cells, causing a pronounced decrease in the blood flow rate. The number of open pores may change with time due to the blocking of open pores and reopening of blocked pores. The following rate equation seems to be usable to simulate the change in open pore number;

$$\frac{dN}{dt} = -\alpha N + \beta(N_0 - N) \quad (1),$$

where N is the number of open pores; N_0 , total number of pores; α , rate constant of blocking; β , reopening rate constant. This equation can be easily solved to give the volume flow rate as

$$\frac{dV}{dt} = k \frac{\beta}{\alpha + \beta} N_0 + k \frac{\alpha}{\alpha + \beta} N_0 \exp(-(\alpha + \beta)t) \quad (2),$$

where k is the proportionality constant of flow rate to open pore number ($\frac{dV}{dt} = kN$). Integrating the above equation, the flow curve is given as

$$V = k \frac{\beta}{\alpha + \beta} N_0 t + k \frac{\alpha}{(\alpha + \beta)^2} N_0 (1 - \exp(-(\alpha + \beta)t)) \quad (3).$$

α is related to the white cell concentration C in the blood sample

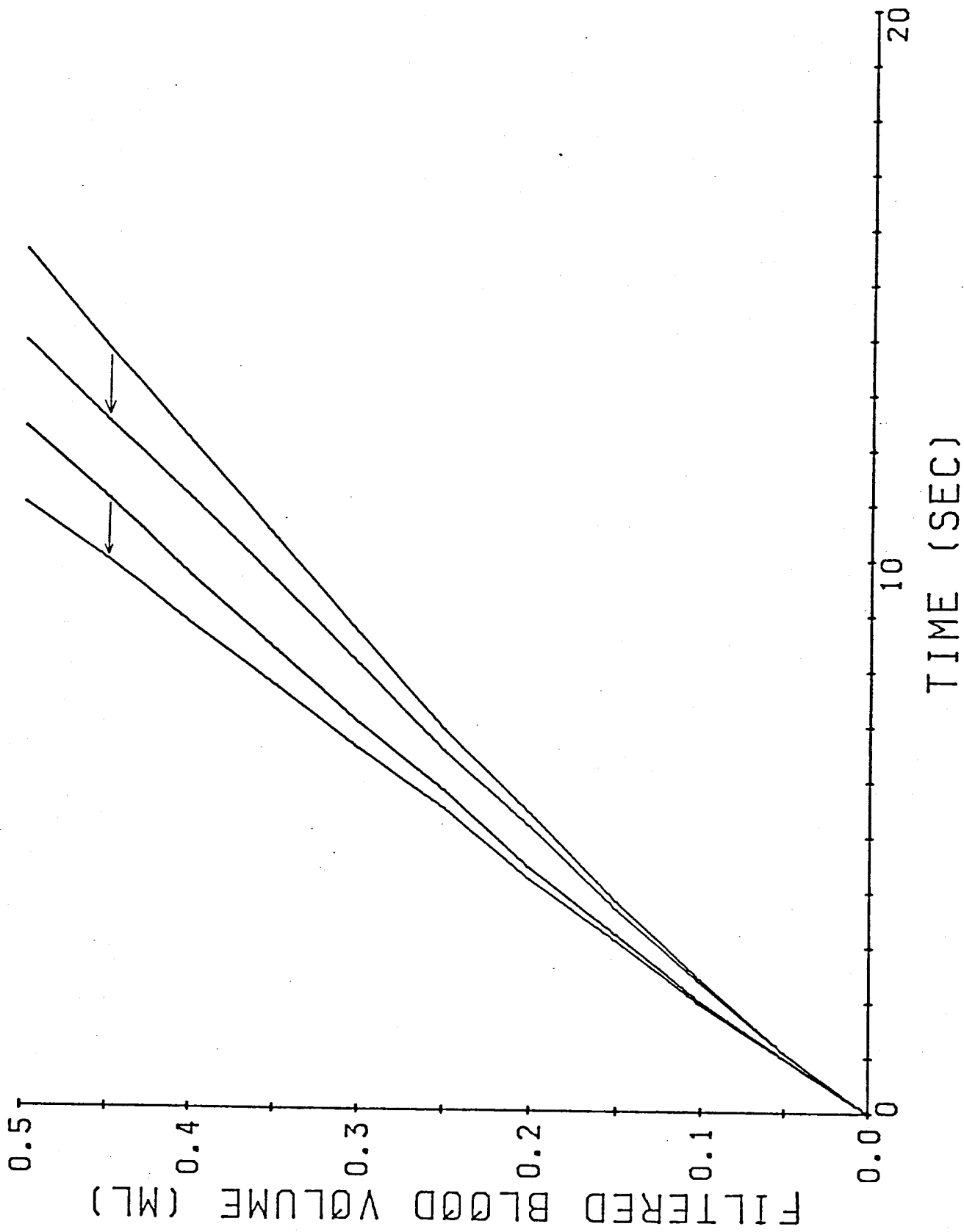

Fig. 3-3. Blood flow curves through the filter : correction for the blood sample weight

as $\alpha = Ck$ (4).

The following consideration seems to be necessary to obtain the relation between β and the mean pore passage time of white cells τ . If it can be assumed that all white cells have the same pore passage time of τ , then the following equation

$$\frac{dN}{dt} = -\alpha N(t) + \alpha N(t-\tau) \quad (5)$$

becomes available to give N . The both models (1) and (5) give similar changes in N as shown in Fig. 3-4. N approaches to a constant value, i.e. a steady state is attained where the pore blocking rate and reopening rate are equal with each other. By comparing the steady state values of N in the above two equations (1) and (5), the relation between β and τ can be obtained. The steady state value of N in the latter equation (5), which cannot be given in a simple form, can be approximated by the values of N at times $t = \tau, 2\tau, 3\tau, \dots$;

$$t = \tau, N(\tau) = N_0 e^{-\alpha\tau}$$

$$t = 2\tau, N(2\tau) = N_0 e^{-\alpha\tau} (e^{-\alpha\tau} + \alpha\tau)$$

$$t = 3\tau, N(3\tau) = N_0 e^{-\alpha\tau} (e^{-2\alpha\tau} + 2\alpha\tau e^{-\alpha\tau} + \frac{1}{2}\alpha^2\tau^2)$$

.....

By equating $\frac{\beta}{\alpha+\beta}N_0$ with one of the above equations, β can be calculated from τ . The curves 2 and 3 in Fig. 3-4 were given from the equation (1) using β determined from $\frac{\beta}{\alpha+\beta}N_0 = N(\tau), N(2\tau)$, respectively. As can be seen in the figure, the first approximation seems to be sufficient for the present accuracy of the measurement.

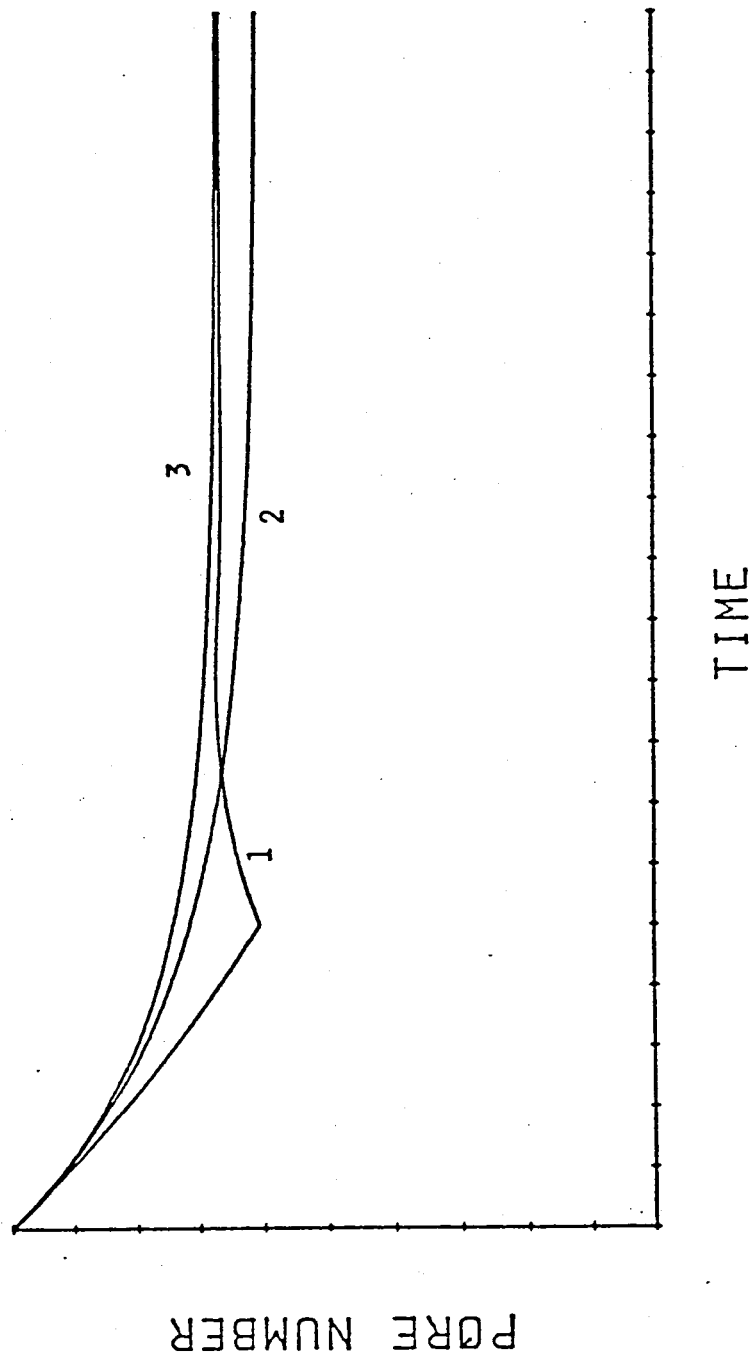

Fig. 3-4. An illustrative comparison of the changes of open pore number in the filter with time during the blood passage calculated from the equations (1) and (5) in the text. Curve 1 shows a solution of the equation (5), while curves 2 and 3 were given by the equation (1) using β determined from the relations $\frac{\beta}{\alpha+\beta} N_0 = N(\tau)$ and $\frac{\beta}{\alpha+\beta} N_0 = N(2\tau)$, respectively.

Then, the following equation

$$\tau = \frac{1}{\alpha} \ln\left(1 + \frac{\alpha}{\beta}\right) \quad (6)$$

is available. This becomes a simple relation of $\beta=1/\tau$ for the case of $\alpha/\beta \ll 1$. An example of flow curves simulated using the equation (3) is shown in Fig. 3-5. The characteristic change in the flow rate becomes more prominent as the mean pore passage time of white cells becomes longer.

Bagge et al. (1977) measured the time length for a granulocyte to be sucked into a glass micropipette with nearly 5 μm diameter. A typical value was given to be about 0.4 sec for the granulocyte to be finally deformed to a cylindrical shape of 5 μm in diameter and 19 μm in length under a pressure difference of 4 cmH_2O . Therefore, the mean passage time of granulocytes through the pores of 5 μm in diameter and 10 μm in length may be estimated to be around 0.1 sec under the present pressure difference. As can be seen in Fig. 3-5, this estimation suggests that the effect of white cells on the blood flow through the 5 μm filter might be less than 5 %. This was confirmed by comparing the flow rates of white cell poor blood samples with those of whole blood samples. The interfering effect of white cells will be negligible unless their deformability might be impaired by sample preparation procedures.

a-5) Hematocrit dependence of the blood passage time

An example of measurements on whole blood of 16 healthy subjects is shown in Fig. 3-6. The passage time of 0.5 ml blood

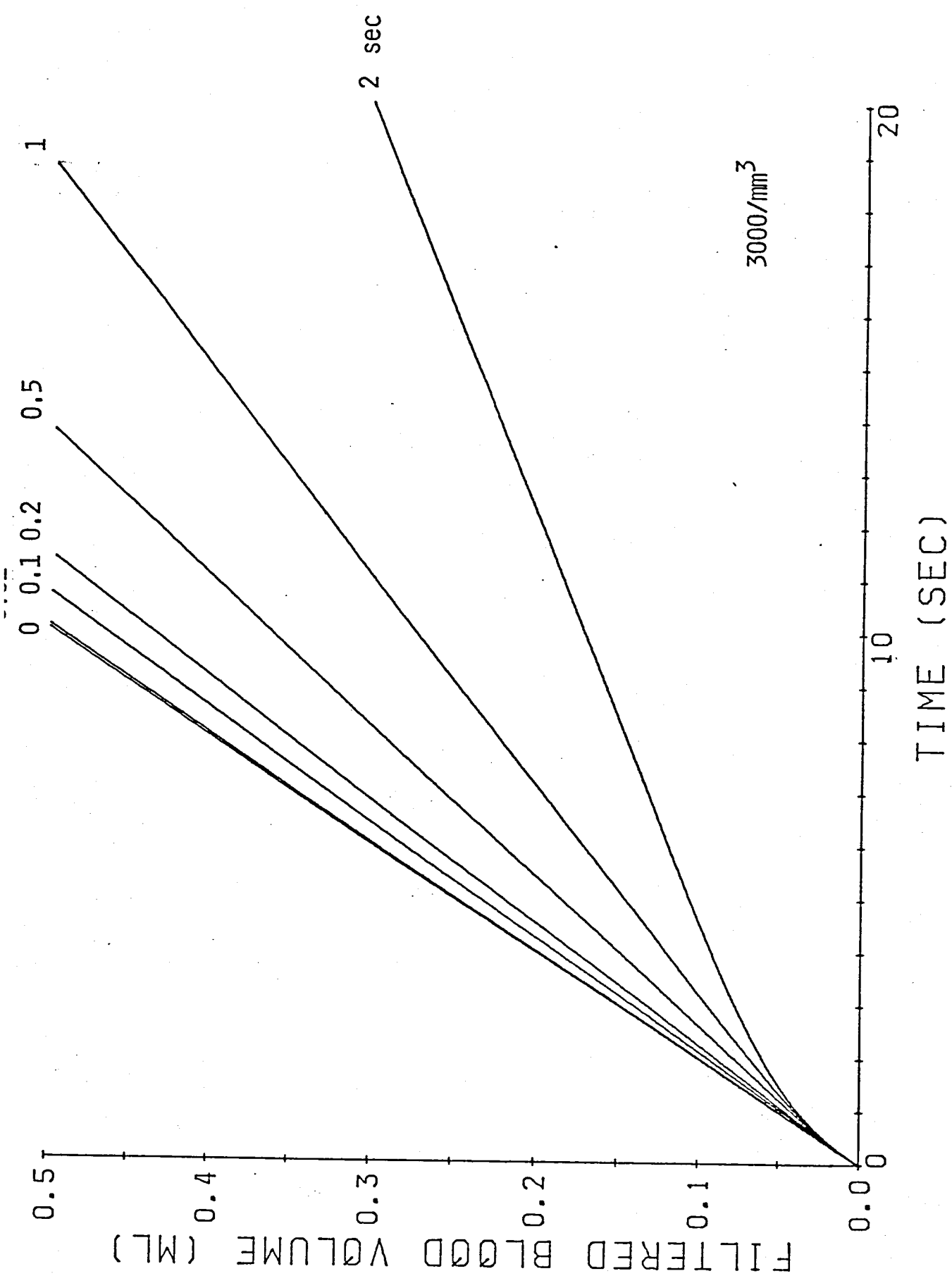

Fig. 3-5. An example of simulated blood flow curves, where the concentration of white cells was taken to be constant. The mean pore passage time was varied from 0.01 to 2 sec.

through the filter was corrected to the one under the pressure difference of 10 cmH₂O and plotted against the hematocrit value. Blood was taken using heparin as an anticoagulant at a ratio of 100 units per 1 ml blood. Blood samples were kept in a water bath of 37°C and measured within 30 minutes after the sampling. As is seen in the figure, the variation in the whole blood passage time is moderate. This suggests that RBC deformability may be well controlled in normal subjects. It is also apparent that the whole blood passage time is related to the hematocrit value. This hematocrit dependence was further studied in 6 subjects, to whom different marks are given in the figure. Blood was diluted with fresh plasma of the same donor and immediately measured. The results are shown in Fig. 3-7. A linear relation between the blood passage time and hematocrit can be seen for hematocrit values below about 30 %. Open circles in the figure show white cell poor blood samples. Whole blood was centrifuged at 5000 G for 10 minutes. The upper half of the red cell column containing buffy coat was thrown away and the remaining lower half was remixed with the plasma. Although white cells might not be completely removed, the number of white cells would be reduced to a great extent by this preparation. The effect of white cells on the whole blood passage time was undetectable under our experimental conditions as suggested in the previous subsection.

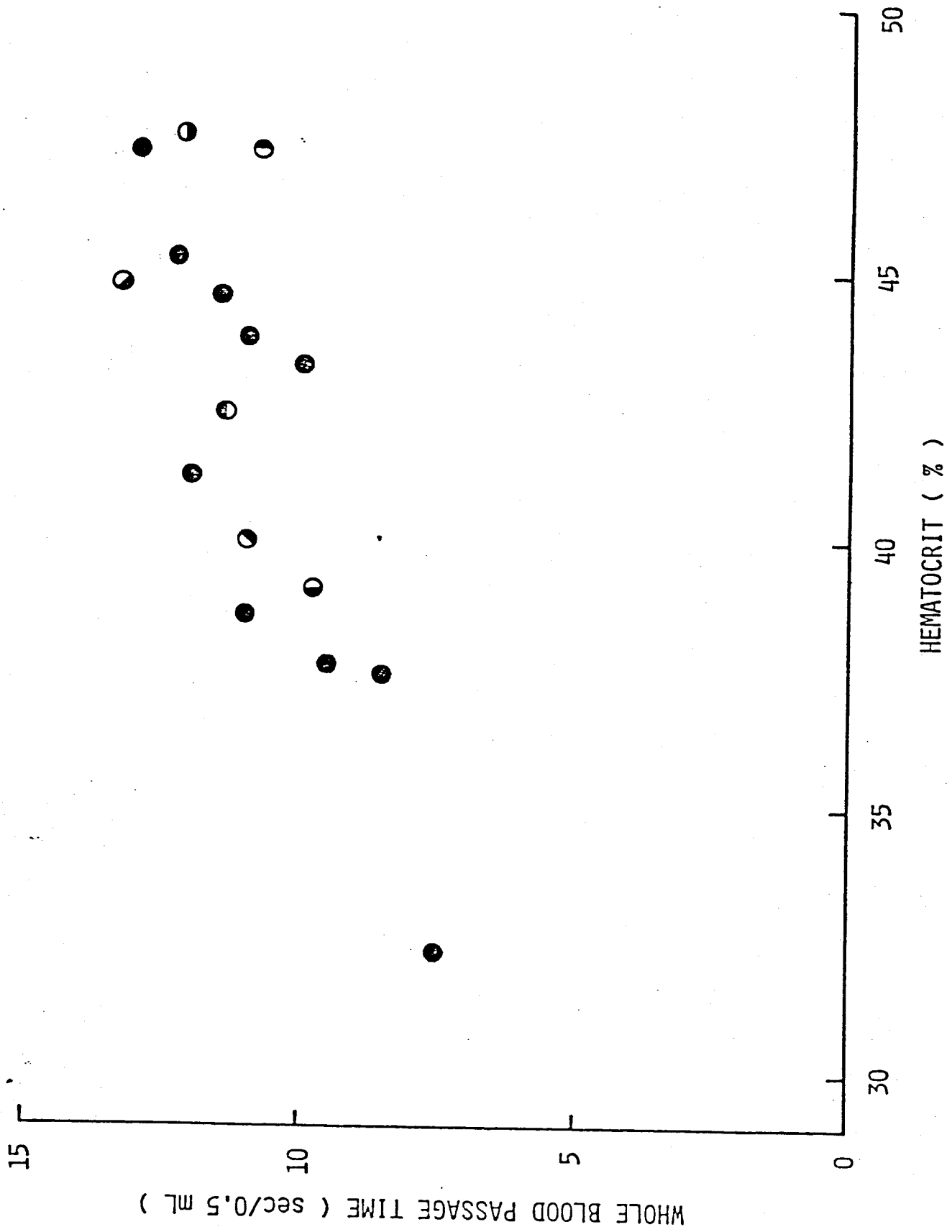

Fig. 3-6. Whole blood passage times and hematocrits in 16 healthy subjects.

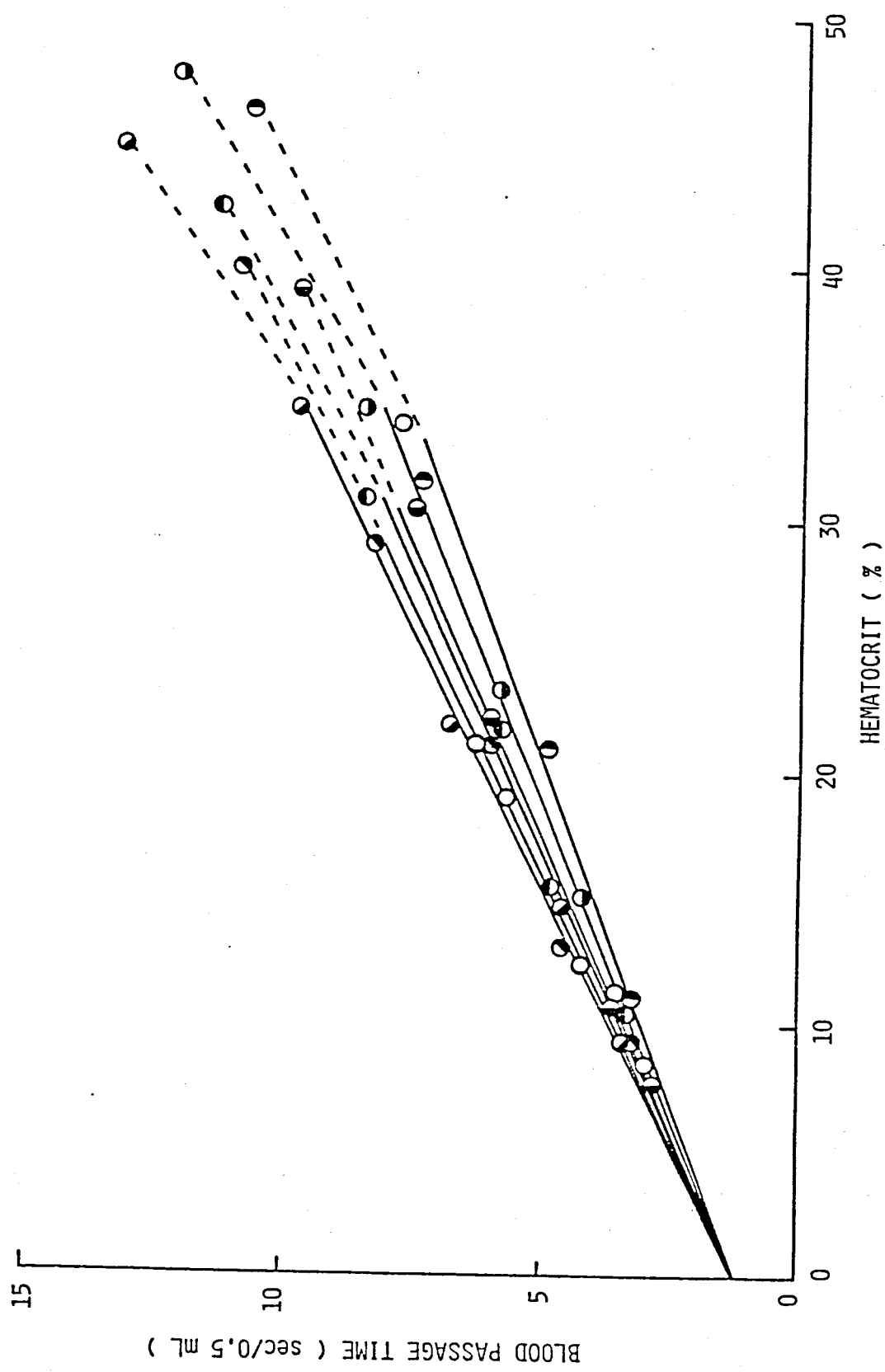

Fig. 3-7. Relations between the blood passage time and hematocrit. Blood samples were diluted with autologous plasma. Open circles show white cell poor blood samples.

a-6) Deformability index

An analysis of the observed hematocrit dependence was given based on a simple filtration model (Kikuchi et al., 1980). The model, which is applicable below hematocrit 30 %, gives an equation expressing the linear relation:

$$T = \left\{ \frac{1}{V_p} + \frac{h_t}{a} \cdot \left(T_{cp} - \frac{a+l}{V_p} \right) \right\} / (A \cdot d \cdot S) \quad (7),$$

where T is the time required for a unit volume of blood to pass through the filter; T_{cp} , average pore passage time of single RBCs; V_p , flow velocity of plasma in a pore; h_t , hematocrit expressed as a decimal; a, average length of a RBC contained in a pore (mean RBC volume/S); l, length of a pore, i.e. thickness of the filter (10 μ m); A, area of the filter effective for filtration; d, pore density; S, cross sectional area of a pore.

A schematic time course of a RBC passage through a pore is shown in Fig. 3-8. The blood passage shown in the figure takes a time length of $T_{cp} + (b-l)/V_p$ and a blood volume of $(a+b)S$ flows in that time length. The blood volume passing through the whole filter in the same time length is given by multiplying $(a+b)S$ with the total pore number of $A \cdot d$. Therefore, T is given as

$$T = \{ T_{cp} + (b-l)/V_p \} / (a+b) \cdot A \cdot d \cdot S \quad (8).$$

While a and b should be related with hematocrit h_t as

$$a/(a+b) = h_t \quad (9)$$

on an average. By putting this relation into (8), the equation (7) is obtained. Applying this equation to measured T and h_t , which must be less than 0.33 ($=a/(a+l)$, $a \approx 5 \mu$ m), T_{cp} can be estimated.

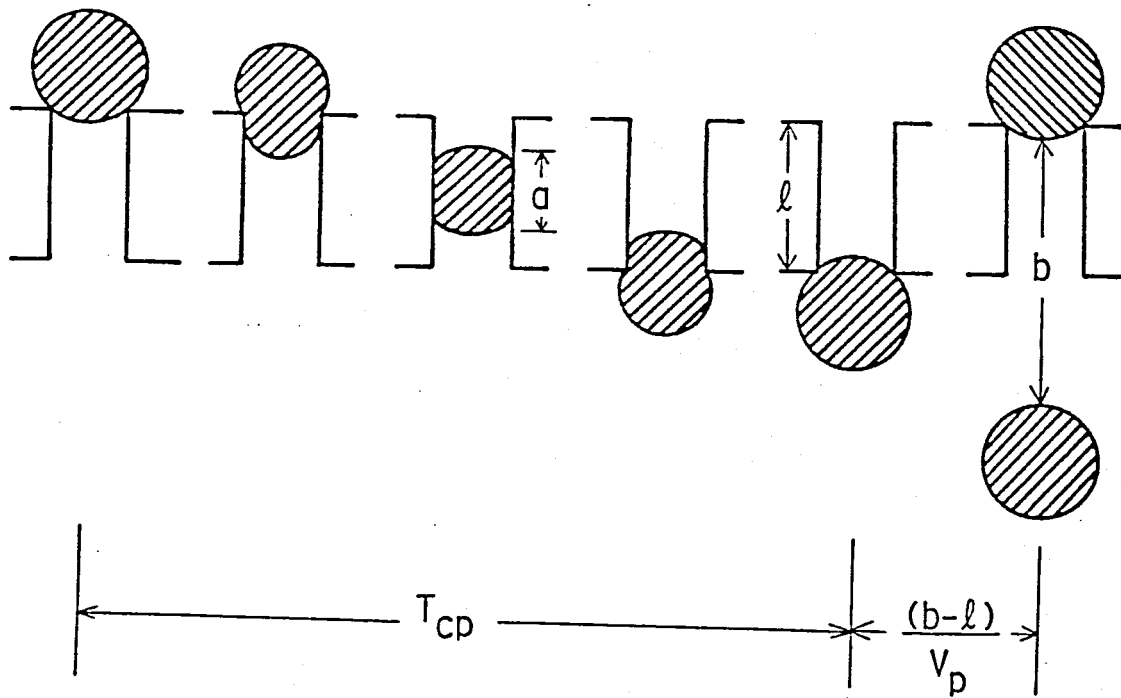

Fig. 3-8. A schematic representation of the passage of a red blood cell through a pore of $5 \mu\text{m}$ in diameter.

Vp can be determined by dividing the flow rate of plasma (the value at hematocrit 0 % in Fig. 3-7) with $A \cdot d \cdot S$, which is the total area in the filter across which flow occurs.

T_{cp} is used as an index of RBC deformability in the present study. T_{cp} may be affected by the lubrication factor acting between the surface of a deformed RBC and the inner wall of the pore. In spite of this drawback, T_{cp} seems to be a well quantified index of RBC deformability at the present as clearly seen in the diagrammatic representation of the RBC passage given in Fig. 3-8. Further, this index might be advantageous since it is directly relevant to the passability of RBCs through blood capillary vessels in-vivo. In this sense, T_{cp} should be designated as an index of the micropore passability of RBCs. Since the term RBC deformability is used rather in a wide sense and it is certain that the importance of RBC deformability is exhibited in the passability of RBCs through capillaries, the two terms RBC deformability and the micropore passability of RBCs are used in the same meaning in the following description.

b) Hematocrit

A small portion of each blood sample was centrifuged at 11,000 rpm for 5 minutes using a hematocrit centrifuger and microhematocrit tubes. The ratio of the length of separated red cell column to the total length (red cell column plus plasma column) in the tube gives the hematocrit (volume percent of RBCs in blood). An average of

coupled measurements was taken as the hematocrit.

c) Ionic osmolarity

The fluid portion of each sample was separated by centrifugation. The osmolarity of the fluid was determined by an osmometer (Knauer Co.), which measures the depression in the freezing point of the fluid due to the ion concentration.

d) Total protein concentration (T.P.)

The refractive index of the fluid medium separated from each sample was measured by an Abbe type refractometer (Atago Co.). The following equation was used to calculate the total protein concentration from the refractive index:

$$\text{T.P.} = (n - 1.33529)/0.00191$$

where n is the refractive index of the medium. This equation was proposed by Yoshikawa (1945) as a slight modification of the Reiss' equation (Sunderman, 1944). In the measurement of T.P. in hyperosmotic media the contributions of the increased ion concentrations in the refractive index were corrected with the values determined by the osmolarity measurement.

e) Colloid osmotic pressure (COP)

The colloid osmotic pressure which is caused by the thermal motions of protein molecules in the plasma was measured by means of a new needle type colloid osmometer which has been developed by

Kakiuchi et al. (1979). The measurement can be made on blood samples without centrifuging them. COP can be determined independently of the ion concentrations of blood samples.

f) Distribution of radio-isotope labeled human serum albumin

The γ radiations from ^{131}I human serum albumin were counted by a scintillation counter on the same volumes of separated red cell and plasma portions. The measurements were carried out at the Isotope Center of Hokkaido University.

4. SAMPLE PREPARATIONS

Since the microrheological properties of RBCs are unstable with time and readily influenced by the changes in the environmental conditions as described before, the following procedures were adopted to minimize the preparation time and artificial treatments added on blood samples.

20 ml venous blood was taken from each of healthy volunteers into a disposable syringe containing 1 ml heparin sodium solution (1,000 units) as an anticoagulant. Plasma was separated from the blood by centrifugation at 5,000 G for 10 minutes. Five plasma samples having osmolarities of five different levels were prepared by adding appropriate amounts of NaCl to the plasma. At the same time five NaCl solutions with osmolarities similar to those of the plasma samples were prepared by adding NaCl to saline. Then, blood was again taken from the same donor and divided into ten portions, which were diluted with the prepared plasma samples and NaCl solutions, respectively. For the sake of brevity, the two kinds of samples are distinguished as PD (plasma diluted) and SD (saline diluted) samples, respectively, in the following description. The PD samples have lowered hematocrits, different osmolarities and a constant plasma protein concentration. Whereas the SD samples have lowered hematocrits and different osmotic pressures in a similar fashion but are distinguished from the PD samples in having decreased concentrations of plasma proteins. For the sake of

comparison serum samples were prepared for two subjects by centrifuging defibrinated blood and used to dilute blood instead of adding plasma. Since no difference was observed between serum diluted and PD samples in the micropore passability of RBCs, the serum cases are included in PD in the following description. The pore passage times of RBCs were measured after 10 minutes incubation at 37°C. Then, hematocrit and osmolarity of each sample were determined using a small portion of the sample.

For the measurements of the total protein concentrations (T.P.) and colloid osmotic pressures (COP) of the suspending media, the sampled blood was first diluted with plasma or saline having normal osmolarity and then divided into five portions, each of which was added crystalline NaCl to increase the osmolarity. The blood samples prepared in this way have the same number of RBCs in a unit volume; the changes in the cell volume due to the different osmotic pressures of the media are reflected in the changes in the hematocrit between the samples. COP was measured directly on the blood samples, while T.P. was measured on the fluid portions separated from the samples by centrifugation.

Similar steps were taken to prepare samples for the experiment using radio-active isotope labeled albumin. 50 µl saline containing 25 µg ¹³¹I human serum albumin was added to 21 ml of the sampled blood. The blood was divided into seven portions, three of which were added NaCl and the other three were added KCl, while the remaining one was used as the control sample. The osmolarities were inc-

reased to three levels of 350, 400 and 450 mOsmol. After 5 hours incubation at 20°C, each sample was centrifuged at 5,000 G for 10 minutes. The radiation was counted on the same volumes of plasma and red cell portions.

As the final experiment different amounts of RBCs washed with saline were added to the separated plasma samples. The suspensions were again centrifuged after 20 minutes incubation. The plasma T.P. was measured on the newly separated fluid media.

5. EXPERIMENTAL RESULTS

The relations between the blood passage time and experimentally altered hematocrit in PD samples having normal osmolarity are already shown in Fig. 3-7. The results obtained in SD samples are given in Fig. 5-1, where the relations show an upward concavity in contrast to the linear relations in PD samples. In Fig. 5-2 a comparison is made between PD and SD samples in one subject. For the sake of further comparison, the relation obtained in RBC suspensions in saline, which were prepared using freshly separated RBCs of the same subject (the samples are denoted as SS), is shown in the same figure. The linear relations in PD and SS samples indicate, as previously shown in Sect. 3, the same micropore passability of RBCs in different PD samples and the same fact for the SS samples. Furthermore, it is noteworthy that the both curves intersect the ordinate at the almost same heights, i.e. plasma and saline without RBCs (hematocrit 0 %) showed the almost same passage times. This is probably because of the small difference in the viscosity between plasma and saline and further because of the short pore length of 10 μm , which seems to be too short for developing the Poiseuille flow in the pore which makes the flow resistance to depend linearly on the viscosity. In other words, differences in the blood passage time are irrespective of the viscosities of the media but are attributable to the differences in the hematocrit and in the pore passage time of RBCs. Therefore,

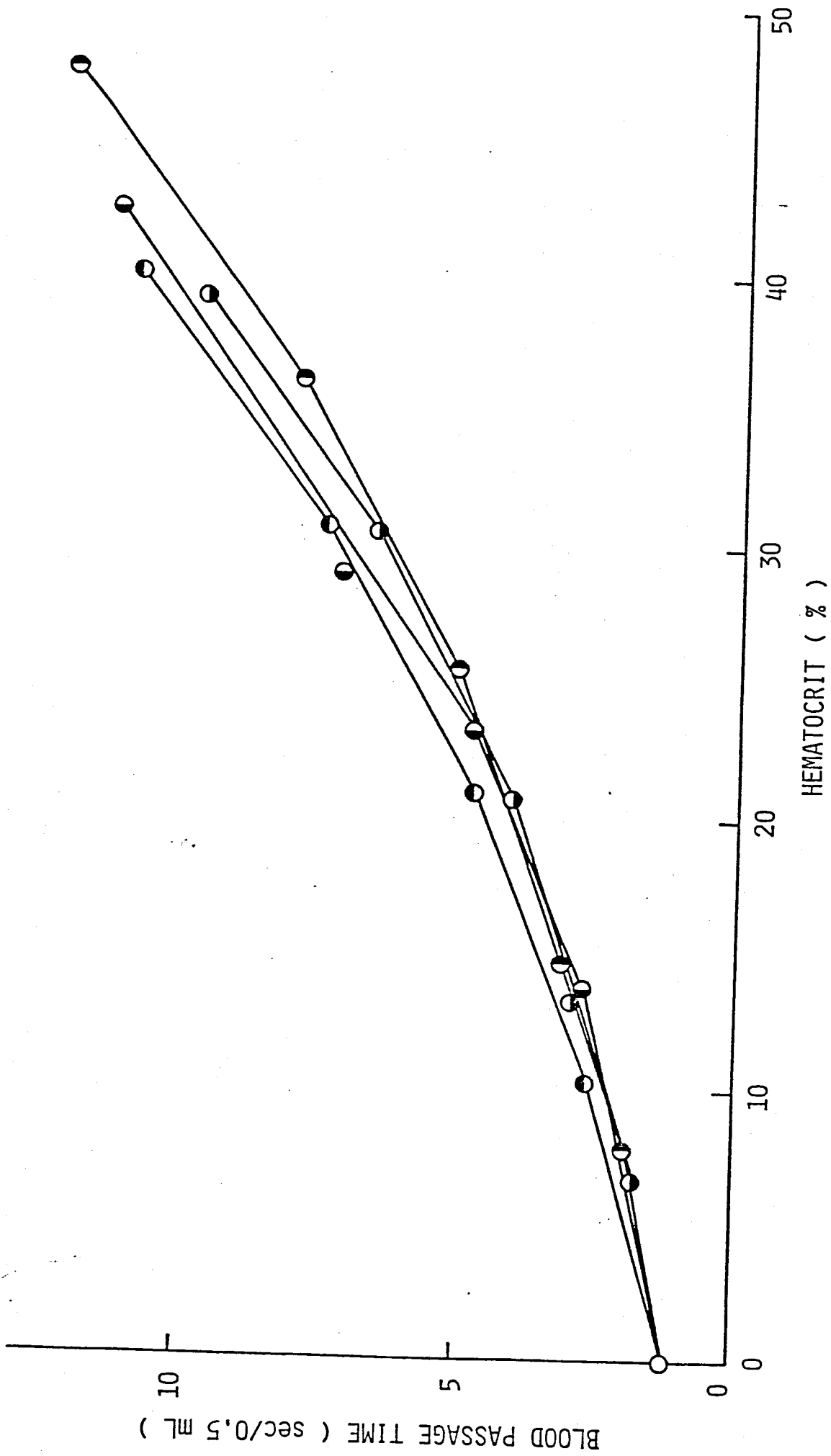

Fig. 5-1. Relations between the blood passage time and hematocrit in SD samples (blood samples diluted with saline).

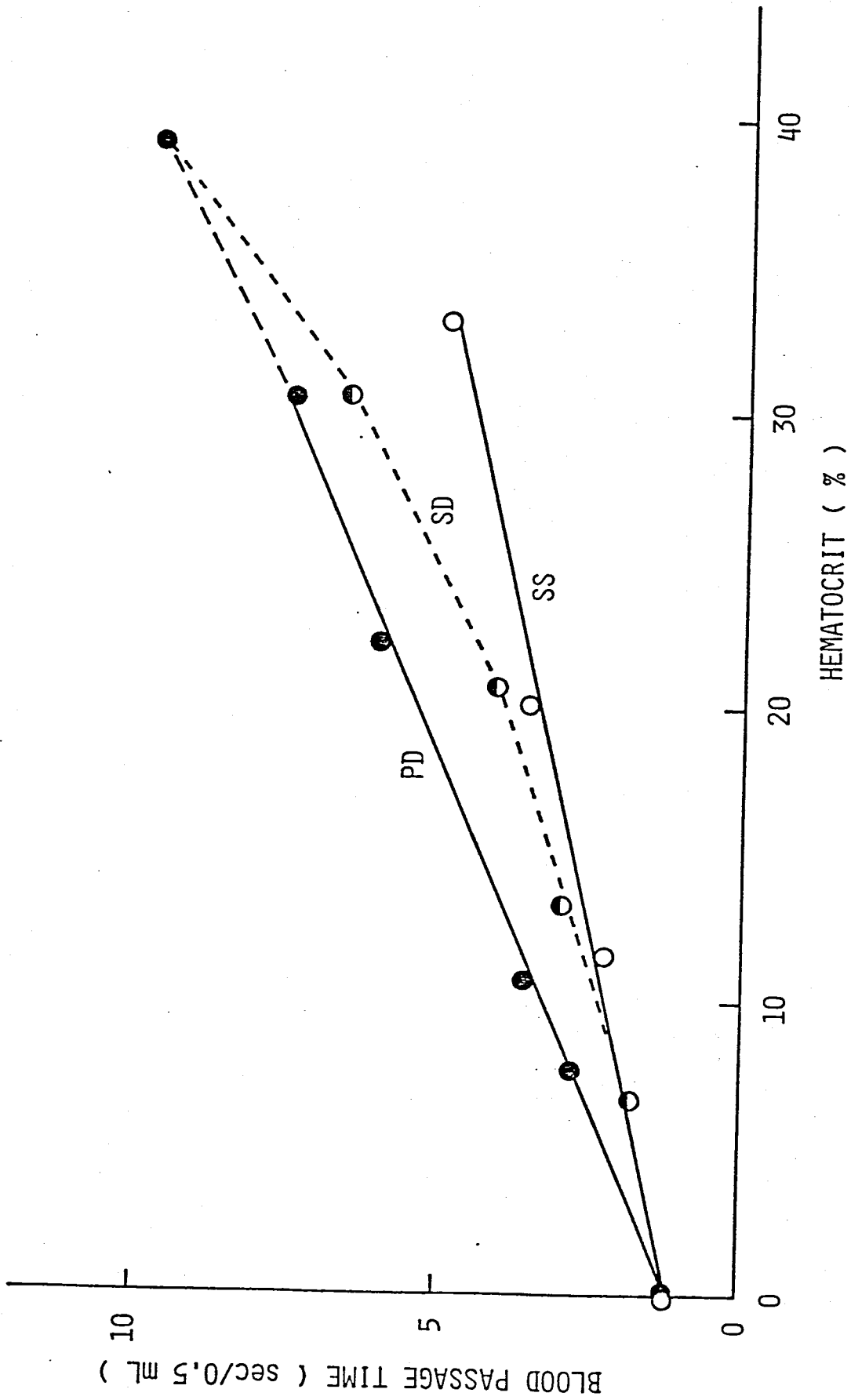

Fig. 5-2. Relations between the blood passage time and hematocrit in PD, SD and SS samples :
a comparison in one subject.

the nonlinear relation in SD samples shown in Fig. 5-2 indicates different micropore passability of RBCs in different SD samples, which seem to result from the altered plasma protein concentrations in SD samples. Whereas the protein concentrations kept constant in PD and SS samples would yield the same pore passage times of RBCs in them. The pore passage times of single RBCs were estimated from the blood passage times and hematocrit values given in Fig. 5-1 and are plotted against T.P. in the media of SD samples in Fig. 5-3. As can be seen in the figure, the micropore passability of RBCs is increased as the plasma protein concentration in the suspending medium is reduced.

The relations between the blood passage time and hematocrit in PD samples having elevated osmolarities are shown in Fig. 5-4. The blood passage time seems to increase linearly with hematocrit up to 20 % with a different slope depending on the osmolarity. Much greater increases in the blood passage time were seen at hematocrit 30 % especially in the samples having higher osmolarities (not shown in the figure). The linear relations shown in Fig. 5-4 indicate that the increased passage times of the samples having hematocrits below 20 % under hyperosmotic conditions are mainly caused by the reductions in the micropore passability of single RBCs, while the nonlinear increases seen above hematocrit 20 % show that the contributions of RBC-RBC interactions become important at higher hematocrits and elevated osmotic pressures.

The upward concavity observed in the relations between the

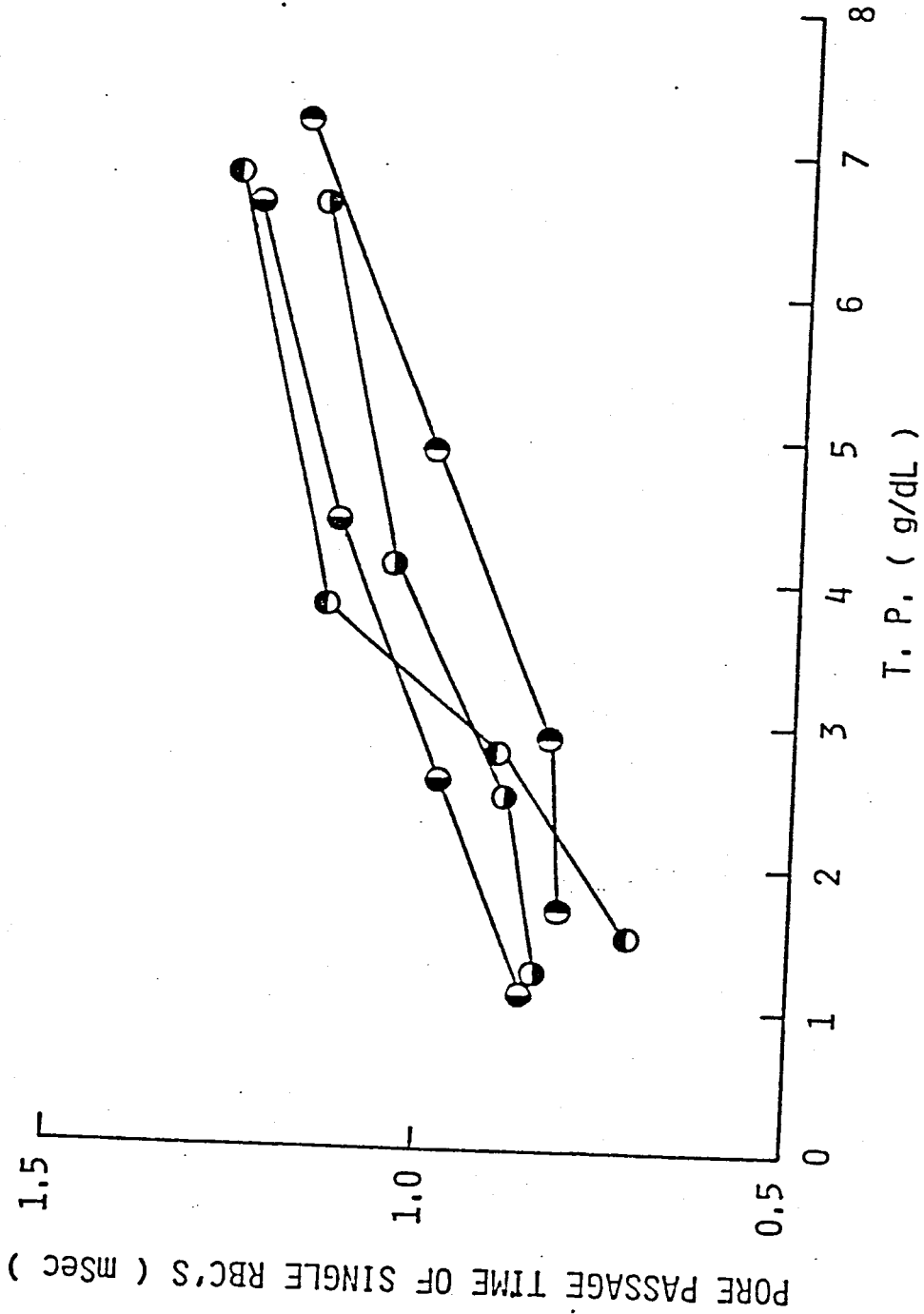

Fig. 5-3. Changes in the pore passage time of single RBCs with plasma protein concentration (T.P.) in the media.

blood passage time and hematocrit in SD samples (Fig. 5-1) was much pronounced under hyperosmotic conditions. The pore passage times of RBCs in PD and SD samples having the same hematocrit values but different osmolarities are compared in Fig. 5-5 (hematocrit 10 %) and in Fig. 5-6 (20 %). The protein concentrations are equal with each other in SD samples with the same hematocrits. As can be clearly seen in Fig. 5-5, the relations between the pore passage time of single RBCs and the osmolarity of the medium are strikingly different in PD and SD samples. The pore passage time of single RBCs is constant up to 430 mOsmol in SD samples, while it increases at 320 mOsmol in PD samples. The different values in PD and SD samples at the same normal 300 mOsmol corresponds to the different blood passage times seen at hematocrit 10 % in Fig. 5-2 and the difference in the pore passage times at normal T.P. and around 1 g/dl in Fig. 5-3. In the case of hematocrit 20 % (Fig. 5-6), the pore passage time of single RBCs starts to increase at 370 mOsmol in SD samples. This result seems reasonable as the protein concentration is higher than in SD samples of hematocrit 10 %. The relation in PD samples coincides with the one in Fig. 5-5 as expected from the linear increases in the blood passage time shown in Fig. 5-4. The marked differences in the effect of hyperosmolarity on the micropore passability of RBCs in PD and SD samples seem to be again closely related with the different protein concentrations in the suspending media as can be supposed from these results.

The T.P. in the fluid media decreases markedly with increasing

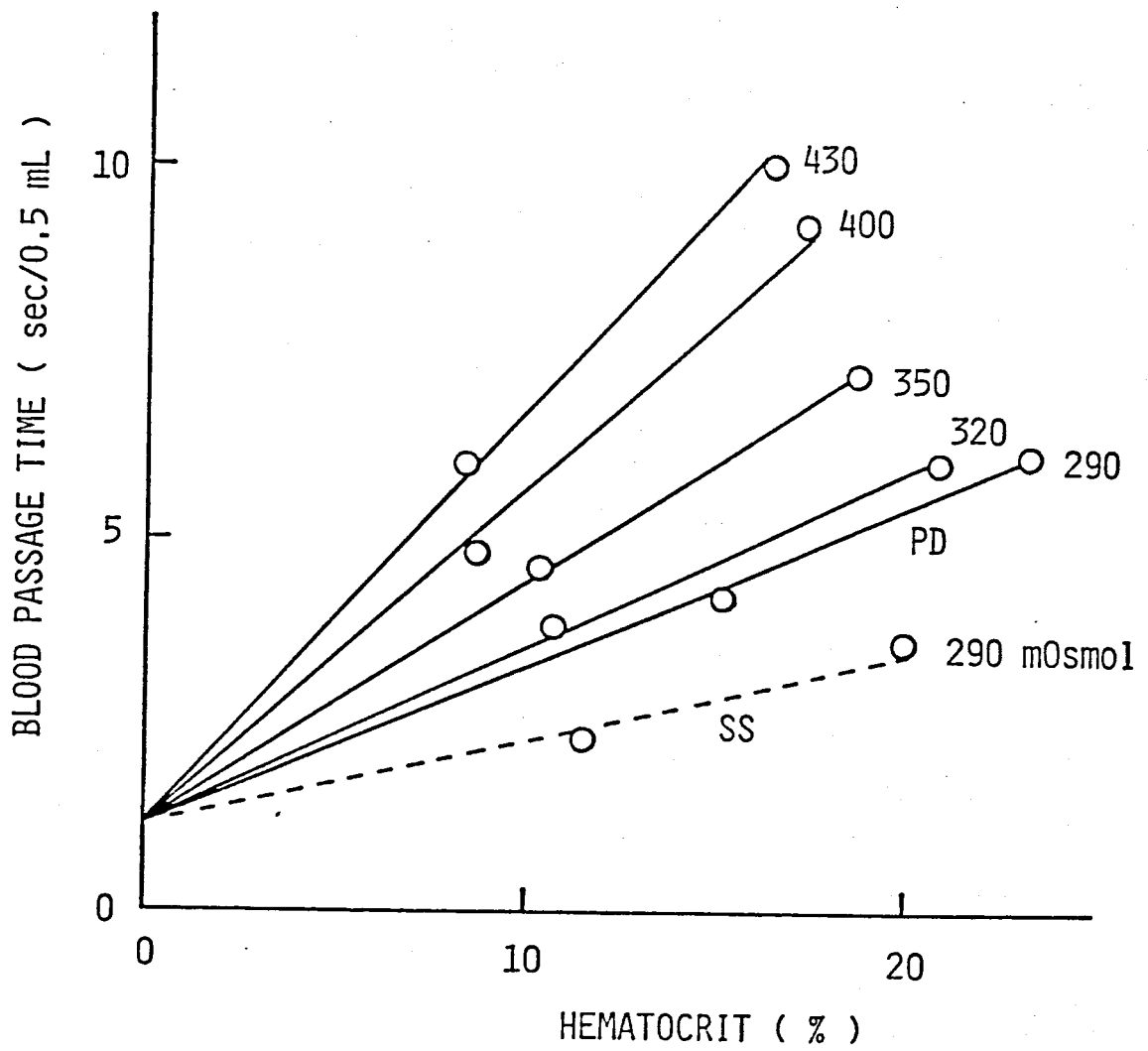

Fig. 5-4. Relations between the blood passage time and hematocrit in PD samples having different osmotic pressures.

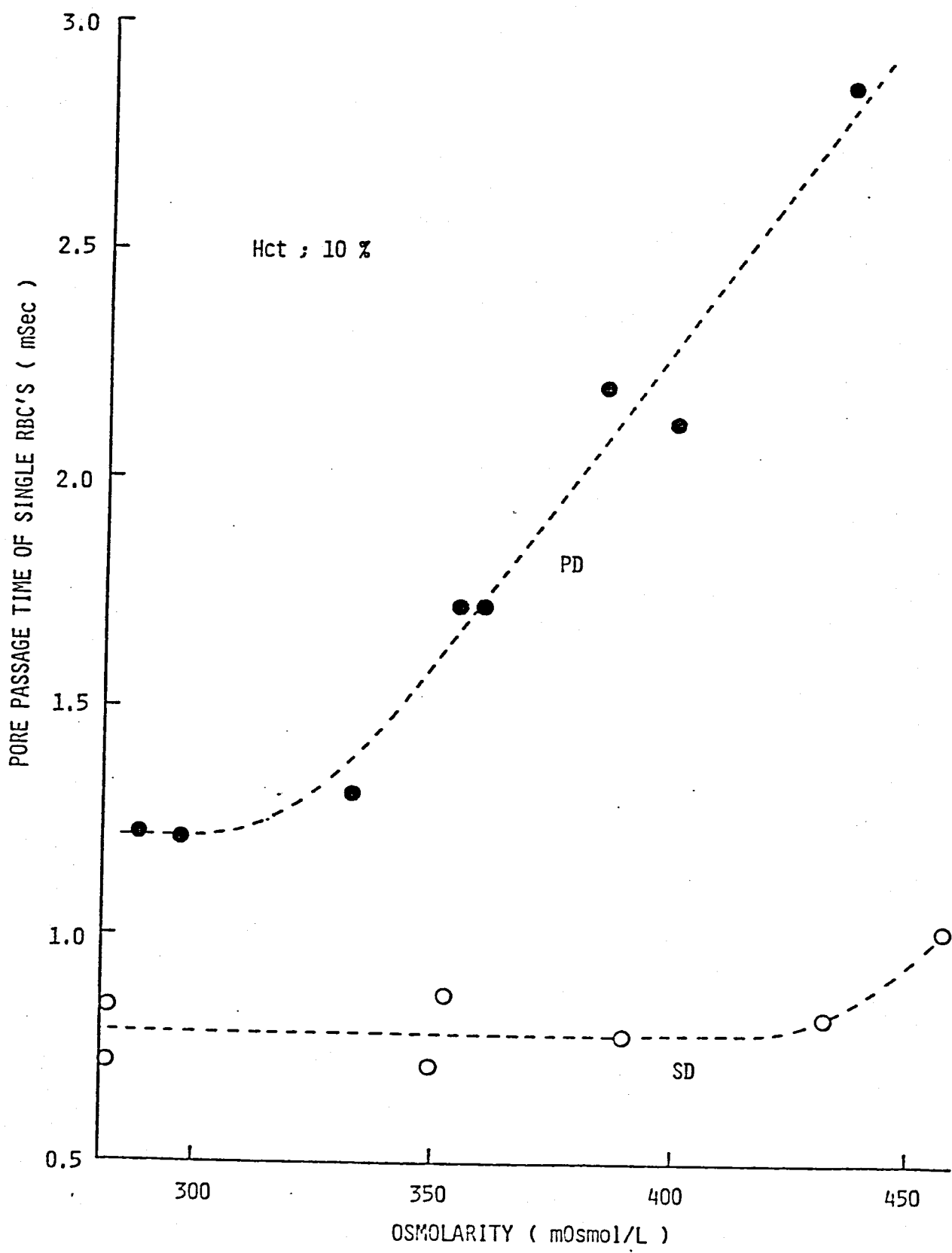

Fig. 5-5. Changes in the pore passage time of single RBCs with increasing osmolarity of the medium. T.P. in PD and SD samples are 6.8 and 1.1 g/dL, respectively.

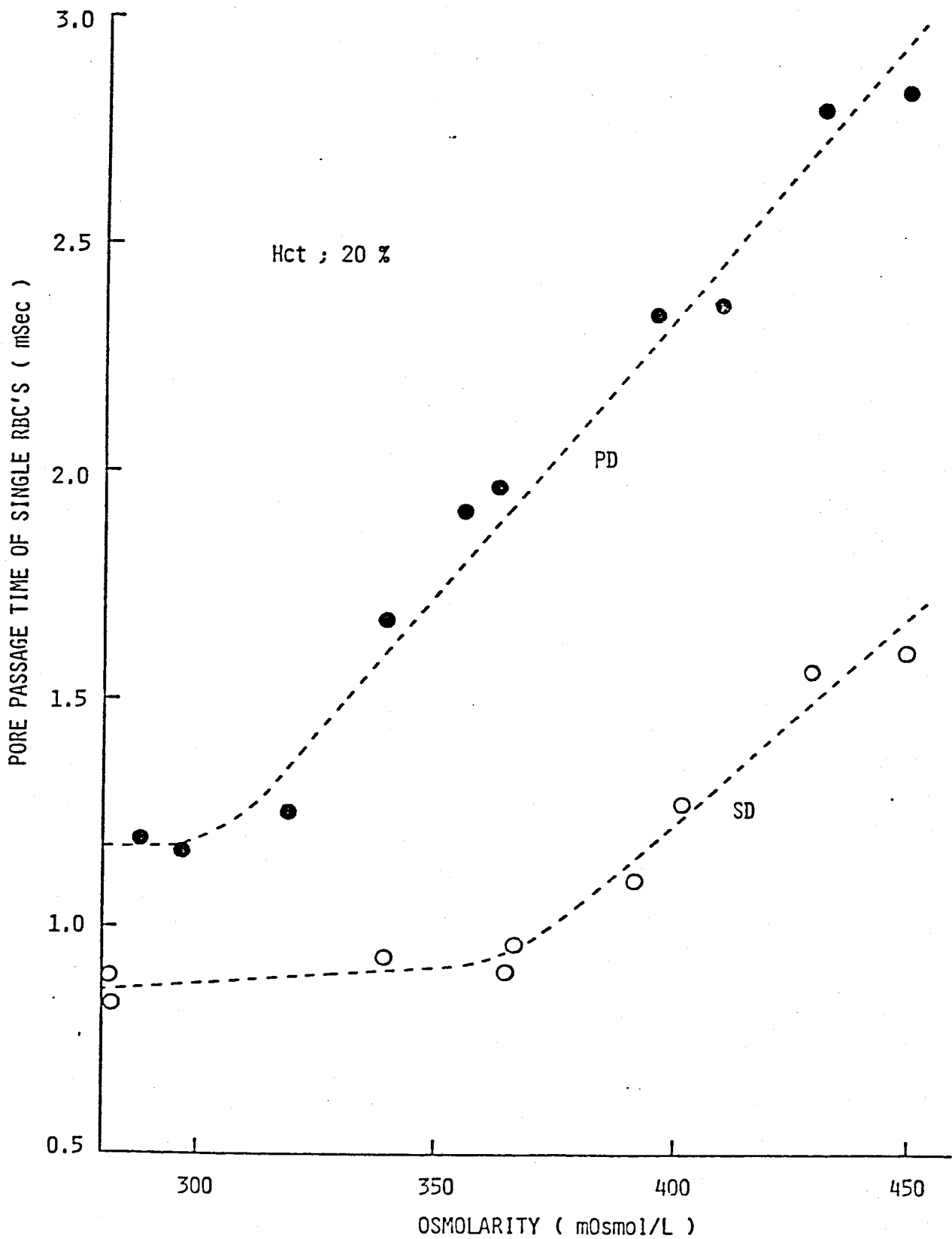

Fig. 5-6. Changes in the pore passage time of single RBCs with increasing osmolarity of the medium. T.P. in PD and SD samples are 6.8 and 2.4 g/dL, respectively.

osmolarity in PD samples (Fig. 5-7a). Whereas no changes in T.P. were observed when the osmolarity of plasma was increased up to 700 mOsmol without the presence of RBCs (Fig. 5-8). Therefore, the reduction in T.P. is related to RBCs or to some interactions between RBCs and plasma proteins. A part of the reduction is obviously due to a simple plasma dilution, as water shifts from RBCs to plasma by the experimentally elevated osmolarity of the plasma. The amount of the water shifted can be estimated from the decreases in the hematocrit of the samples. The levels of protein concentrations expected from the water shifts are shown by the dotted lines in Fig. 5-7. The actually observed reductions in the protein concentration clearly exceed the estimated levels as shown by the solid lines in Fig. 5-7a. The excess reduction in the protein concentration in the medium is supposed to be caused by the interactions between RBCs and plasma proteins which would be strengthened under hyperosmotic conditions. On the other hand, the protein concentrations in SD samples decrease slightly in accordance with the plasma dilution due to the water shift (Fig. 5-7b). When these results are compared with the relations shown in Fig's 5-5 and 5-6, it can be said that the greater the decrease in the plasma protein concentration, the longer becomes the pore passage time of single RBCs. The relations between the protein concentration and osmolarity in PD samples obtained at three hematocrit values are shown in Fig. 5-9. The excess reduction in the protein concentration was estimated at a constant osmolarity as the difference between the solid and dotted

lines. Thus, the excess reduction in the protein concentration due to the RBC-protein interactions could be plotted against the hematocrit value. An example obtained at the osmolarity of 400 mOsmol is shown in Fig. 5-10.

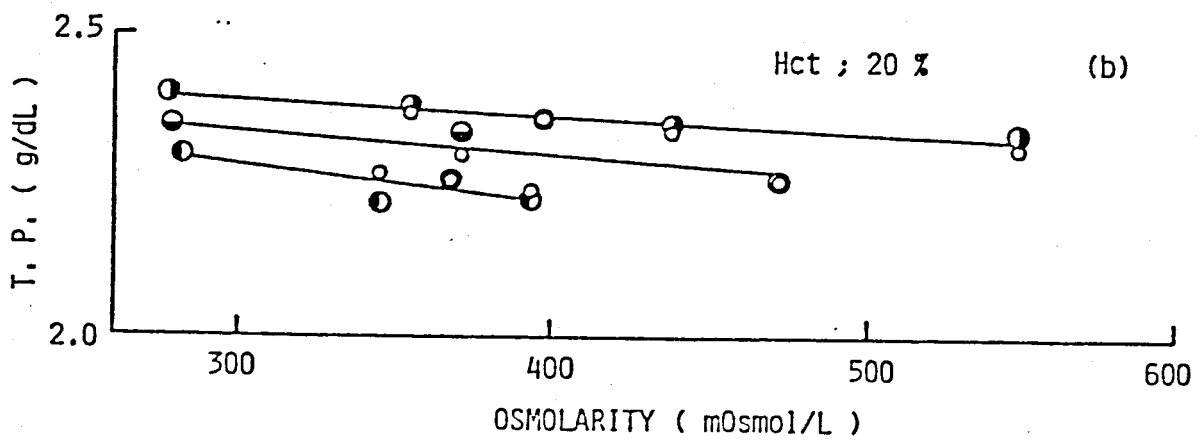
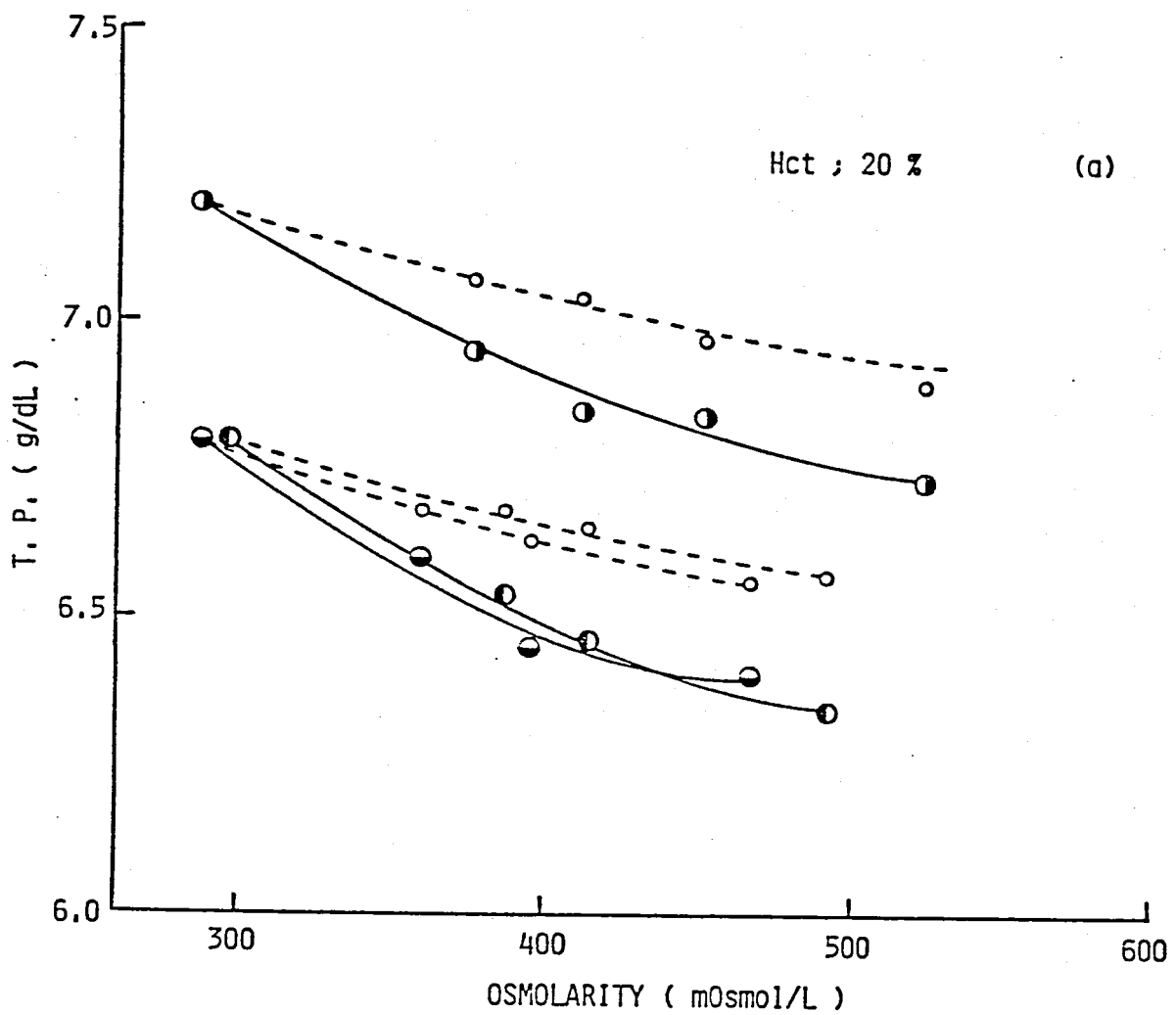

Fig. 5-7. Changes in T.P. detectable in the fluid media of PD (a) and SD (b) samples. The changes in T.P. due to the osmotic water shift (simple plasma dilution) were estimated from changes in the hematocrit of samples and are shown by small open circles.

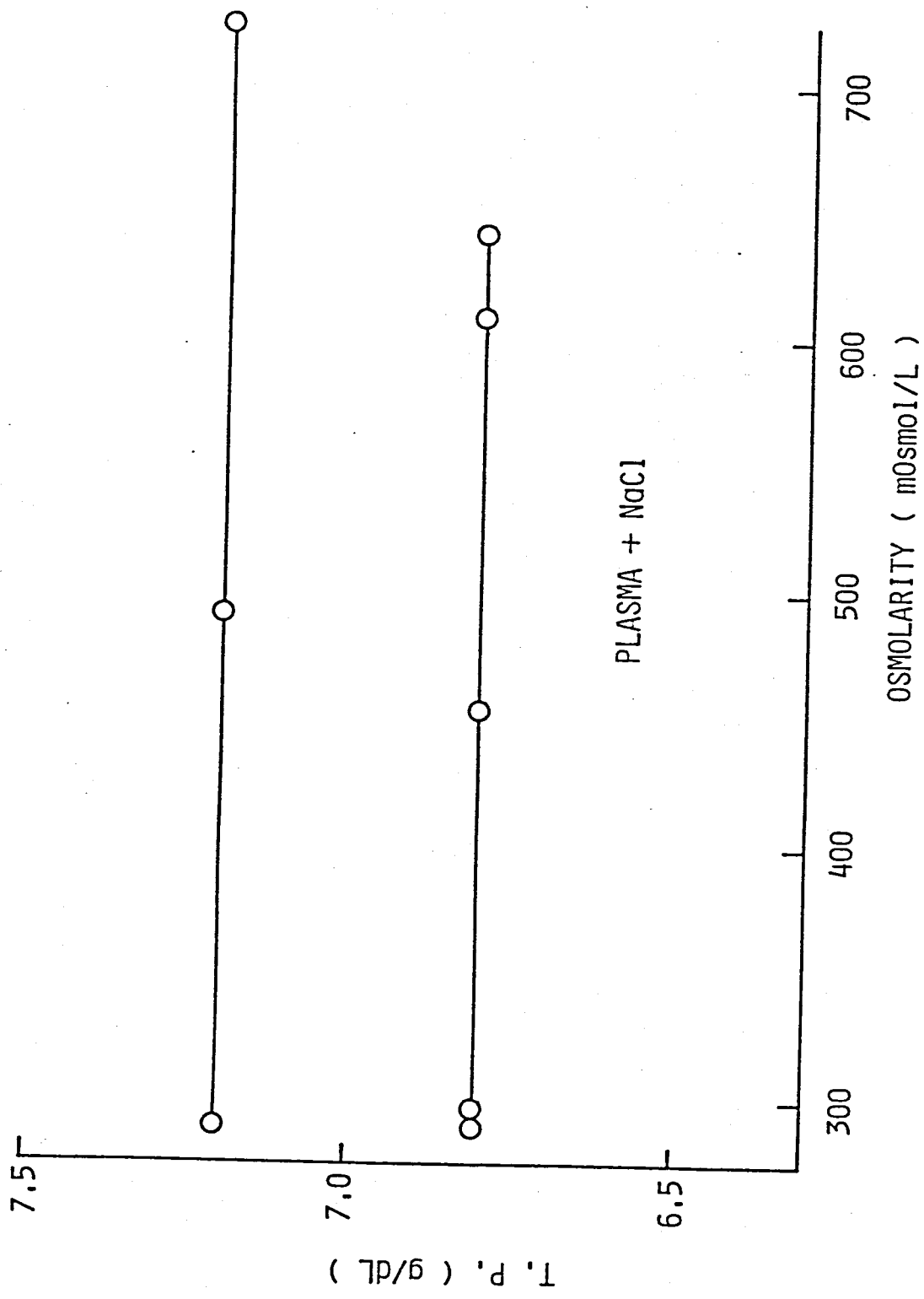

Fig. 5-8. Total protein concentrations in the plasma samples whose osmotic pressures were elevated by additions of crystalline NaCl. No RBCs exist in the samples.

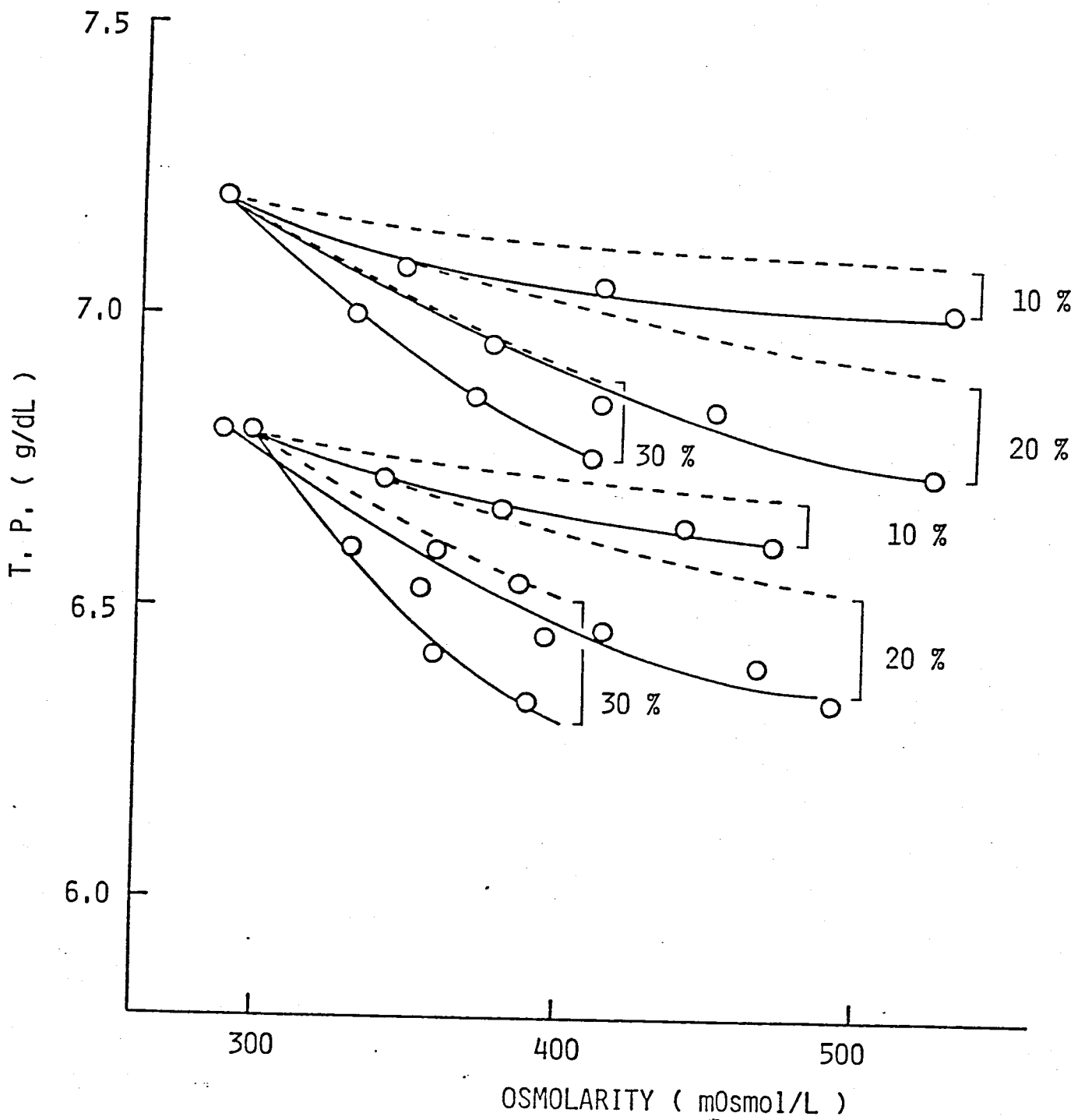

Fig. 5-9. Changes in T.P. in the fluid media of PD samples having different hematocrits with increasing ionic osmolarity of the media.

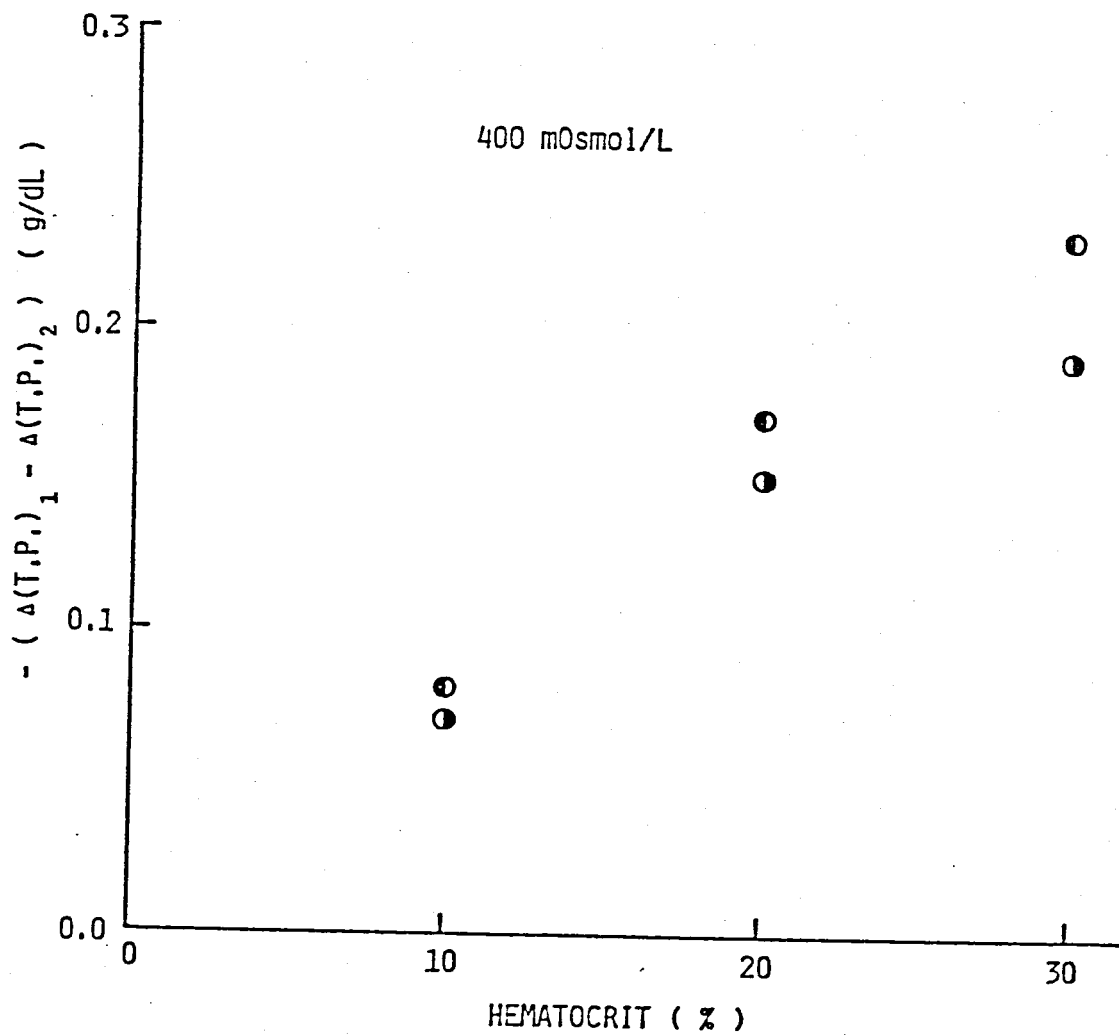

Fig. 5-10. The relation between the excess reduction in the plasma protein concentration and hematocrit when the ionic strength of the fluid media was kept constant at 400 mOsmol. $\Delta(T.P.)_1$; the observed reduction in the protein concentration, $\Delta(T.P.)_2$; the reduction estimated from the osmotic water shift.

6. DISCUSSION

The most obvious difference between the PD and SD samples exists in the concentrations of plasma proteins in the fluid media as often noted in the previous sections. Therefore, it seems reasonable to attribute the observed striking differences in the effect of hyperosmolarity on the micropore passability of RBCs in PD and SD samples to the different plasma protein concentrations in the fluid media. Since the RBC surface is in close contact with the surrounding fluid, there should be interactions between the RBC membrane constituents and plasma proteins in the medium. The interactions, which will be modified by the concentrations of plasma proteins themselves and ions in the medium, will significantly influence the physical properties of the RBC membrane. The importance of the interactions between the cell membrane constituents and proteins within the cell at the inner surface has been noted by Weed et al. (1969) in studies on the effect of cellular metabolic states on RBC deformability. The interactions between the outer surface of the cell membrane and plasma proteins have been partly exhibited as a protective effect of albumin against the cell membrane rupture due to hypoosmolarity (Katchalsky et al., 1960) and strong mechanical stresses (Williams, 1973). The importance of the RBC-plasma protein interactions for RBC deformability has been clearly demonstrated by the present experimental results. The pore passage time of RBCs becomes shorter as the protein concentration in the medium is reduced (Fig. 5-3).

The effect of hyperosmolarity on the micropore passability of RBCs disappears up to 370 and 430 mOsmol when the protein concentration in the medium is lowered to 1/3 and 1/6 of the normal level, respectively (Fig's 5-5 and 5-6). This result further suggests that the reduced RBC deformability having been considered to be caused directly by the effect of hyperosmolarity, i.e. by the water shift, may rather be a result of the strengthened interactions between RBCs and plasma proteins under hyperosmotic conditions. The reduction in RBC deformability exposed to hyperosmolarity has been attributed to an increased internal viscosity due to the loss of water from the inside of RBCs. However, it is obvious that this assumption cannot explain the present results, since the dehydration of RBCs proceeds similarly in both PD and SD samples. Besides, the actually observed decreases in the hematocrit in SD samples seemed to exceed slightly those in PD samples. The internal viscosity will be still too low to affect the deformability, even though increased considerably. The supposition that the RBC-protein interactions may play essential roles in the phenomena seen under hyperosmotic conditions is supported by the observations that the reduction in RBC deformability seems to accompany an increase in the adsorption of plasma proteins to RBCs (Fig's 5-5, 5-6 and 5-7). The increased adsorption of plasma proteins to the RBC surfaces was clearly demonstrated by the excess reduction in the protein concentration in the medium under elevated osmolarity (Fig. 5-7). When the adsorption of plasma proteins to RBCs increases under hyperosmotic

conditions, the protein concentration detectable in the medium further decreases from the level expected from the plasma dilution by the amount of proteins adsorbed, causing the excess reduction. The possibility that the plasma proteins may aggregate with each other to cause an apparent reduction in T.P. is eliminated since no changes in T.P. were observed up to 700 mOsmol when the osmolarity of plasma was increased without the presence of RBCs (Fig. 5-8). Further, the observation that the excess reduction in T.P. seems to be proportional to the hematocrit within the studied low hematocrit region (Fig. 5-10) indicates that the decrease in T.P. is related to the whole surface area of presenting RBCs, also suggesting the possibility of the adsorption of plasma proteins to the RBC surfaces.

A more clear evidence of the protein adsorption to RBCs was obtained in the experiment using ^{131}I human serum albumin. The radiation count on the separated RBC portion increases as the osmolarity of the medium is elevated (Fig. 6-1). Since albumin cannot penetrate the red cell membrane, the increase in the number of ^{131}I human serum albumin counted in the RBC portion shows the increase in the adsorbed albumin to the RBC surfaces. Now it seems certain that the adsorption of plasma proteins to the red cell membrane increases as the osmolarity of the medium is elevated.

The lowered protein concentration in the medium, which will encourage the adsorbed proteins to redissolve into the fluid, causes an amelioration of RBC deformability at normal osmolarity

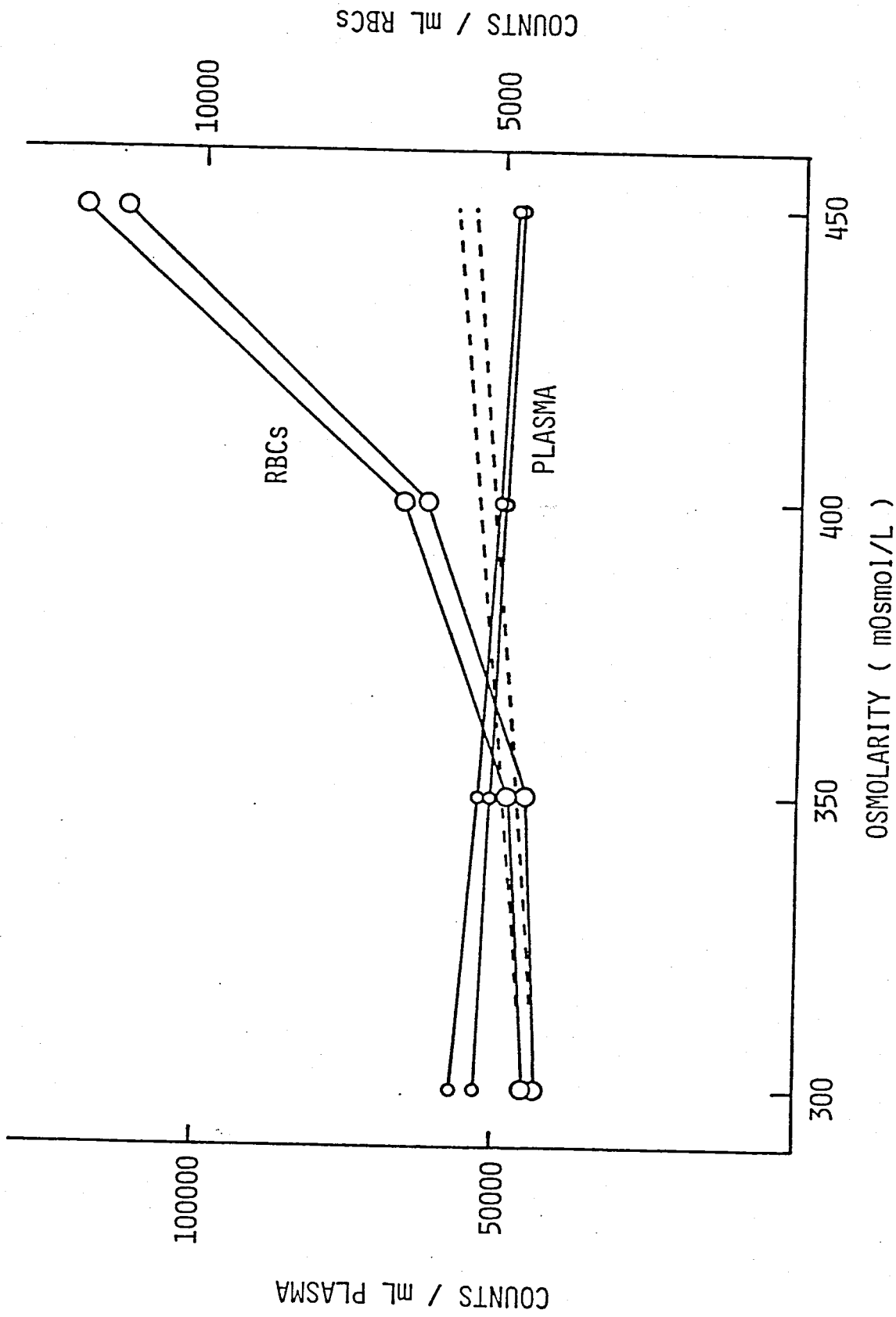

Fig. 6-1. γ radiation counts from the separated RBC and plasma portions of the blood samples containing ^{131}I human serum albumin.

(Fig. 5-3). The micropore passability of RBCs decreases when the adsorption of proteins to the RBC surfaces increases with osmolarity, while RBC deformability remains constant when no increase in the protein adsorption is seen (Fig's 5-5, 5-6 and 5-7). Therefore, it can be supposed that the adsorbed proteins restrict the cell membrane flexibility to cause a reduction in the deformability.

As discussed above, the contribution of added NaCl to the deformability through the increase in osmotic pressure of the medium is less important but their direct effect as ions seems to be primary in the phenomena observed under hyperosmotic conditions. It has been known that the electric repulsive force between colloid particles suspended in an electrolyte solution is weakened as the ionic strength of the solution is increased and that the colloid particles finally aggregate with each other to cause the sedimentation above a certain critical value of the ion concentration. The so-called DLVO theory (Derjaguin and Landau, 1941; Verwey and Overbeek, 1948) has been established to explain the stability of colloid suspensions taking into account the electric double layer interaction and the van der Waals interaction. The interactions between RBCs and plasma proteins taking place in blood will be similarly the electric repulsive forces between the negative charges on the both surfaces and the van der Waals attractive forces. The electric repulsive force may probably be reduced, as supposed from the general cases of colloid suspensions, when the ionic strength of the medium is increased. Therefore, when the strengths of the

both interactions are of the same order, the reduction in the electric repulsive forces will accelerate the adsorption of plasma proteins to the red cell surfaces. The surface potential of RBCs has been reported to be around -10 mV. This causes an electric repulsive interaction of the order of 10^{-20} Joule against a protein, whose negative charge is estimated to be of several tens of the charge of an electron, i.e. $\sim -10^{-18}$ Coulomb at blood pH 7.4. While the van der Waals attractive interaction can be shown to be of the same order of 10^{-20} Joule (see APPENDIX). The thermal energy kT is 0.4×10^{-20} Joule ($37^\circ\text{C} = 310 \text{ K}$). Therefore, the interaction energies relating to the adsorption of plasma proteins to the red cell surface and releasing of adsorbed proteins from the surface are of the same order, supporting the above considerations. Further, the surface potential of RBCs and negative charges of proteins may be reduced by the adsorption of cations to RBCs and proteins. Haydon and Seaman (1967) reported that the zeta potential of RBCs decreases with the increasing concentration of NaCl in the medium. The decrease in the surface potential of RBCs directly reduces the electric repulsive interaction, encouraging the adsorption of plasma proteins to RBCs. These considerations seem to be able to explain the present results consistently.

The following order-estimations can be made for the amount of adsorbed proteins to RBCs based on the radiation count experiment. The added amount of ^{131}I human serum albumin (^{131}I HSA) is

1.2 μg ^{131}I HSA / ml blood (hematocrit 40 %)

or 2.0 μg ^{131}I HSA / ml plasma.

The average T.P. (6.7 g/dl) and ratio of albumin to globulin (A/G=1.5) in the plasma give the concentration of native albumin as 4.0 g/dl plasma.

Therefore, the ratio of radio-isotope labeled albumin to native ones is 1 : 20,000.

Using the following notations:

Crbc ; radiation counts / ml RBCs,

Cplasma ; radiation counts / ml plasma

and Hct ; hematocrit value expressed in decimal,

the amount of albumin existing on the RBC surfaces is given as

$$1.2 \times \frac{\text{Crbc} \cdot \text{Hct}}{\text{Cplasma} \cdot (1 - \text{Hct}) + \text{Crbc} \cdot \text{Hct}} \times 20,000 \mu\text{g} / \text{ml blood.}$$

The results shown in Fig. 6-1 yield the following values;

1.1 mg albumin / ml blood at 300 mOsmol

and 2.2 mg albumin / ml blood at 450 mOsmol.

Since the molecular weight of albumin is 66,000, these values are converted to

2.2×10^6 albumin / RBC at 300 mOsmol

and 4.4×10^6 albumin / RBC at 450 mOsmol.

The additionally adsorbed proteins to RBCs at 450 mOsmol cause a reduction of 0.18 g/dl in T.P. in the plasma. These estimations assume that the affinity of ^{131}I HSA to the red cell membrane is exactly the same with that of native albumin and that the equilibrium distribution of ^{131}I HSA is fully attained after the incubation time.

The average dimensions of the red cell are given in Fig. 2-1. When an albumin molecule is assumed to be a sphere having a radius of 30 Å, the maximum number of albumin molecules which can be packed in a single layer covering the whole surface of a red cell can be estimated to be 4.8×10^6 / RBC. The above value of 2.2×10^6 / RBC (at 300 mOsmol) is a half of this maximum number.

When compared to the results given in Fig. 5-10, the estimated amount of the additionally adsorbed proteins to RBCs from the radiation counts is rather smaller than the one observed as a reduction in T.P. in plasma. As can be seen, the estimated value gives the amount of plasma albumin adsorbed to RBCs, while the reduction in T.P. is measured for the total plasma proteins. If globulin are adsorbed to the RBC surfaces similarly to albumin, then the estimated values should be further multiplied by the ratio of T.P. to albumin for the amount of total proteins adsorbed to RBCs. The following values are given;

1.8 mg plasma proteins / ml blood at 300 mOsmol
or 4.6 mg plasma proteins / ml RBCs at 300 mOsmol.

The reduction in T.P. in plasma due to the protein adsorption is now 0.3 g/dl at 450 mOsmol, coinciding well with the ones given in Fig. 5-10.

The amount of plasma proteins adsorbed to RBCs at normal osmolarity can also be estimated from the measurement of T.P. in plasma. A decrease in T.P. was observed due to the addition of RBCs washed with saline to the plasma. Since the adsorbed proteins will be

removed by washing with saline and the protein layer will be formed again when the washed RBCs are resuspended in plasma, the observed reduction in T.P. will show the amount of plasma proteins adsorbed to RBCs at normal osmolarity. By adding different amounts of washed RBCs to plasma, the decrease in T.P. in the plasma was determined as a function of the amount of added RBCs. The results are shown in Fig. 6-2. The obtained values coincide with the one estimated from the radiation counts and corrected to the total proteins, suggesting a similar adsorption of globulin to the RBC surfaces. However, there remains a possibility of accident in this agreement between the estimated amounts of proteins. Considerable errors are suspected to be involved in the both experiments. Further, the assumptions in the estimation of the amount of adsorbed proteins from the radiation counts might be incorrect. There can be seen different tendencies between the reduction in T.P. (Fig. 5-7) and the increase in the radiation counts from RBCs (Fig. 6-1). The reduction in T.P. proceeds with osmolarity and shows a saturating tendency at high osmolarities, while the increase in the radiation counts becomes prominent above 400 mOsmol. It seems highly possible that the processes of purification and labeling of albumin may cause slight modifications in the nature of albumin. If the affinity of ^{131}I HSA to the red cell membrane is lower than that of native albumin, the radiation counts give under-estimations for the amount of adsorbed proteins.

Relating to this problem, it may be interesting to show a

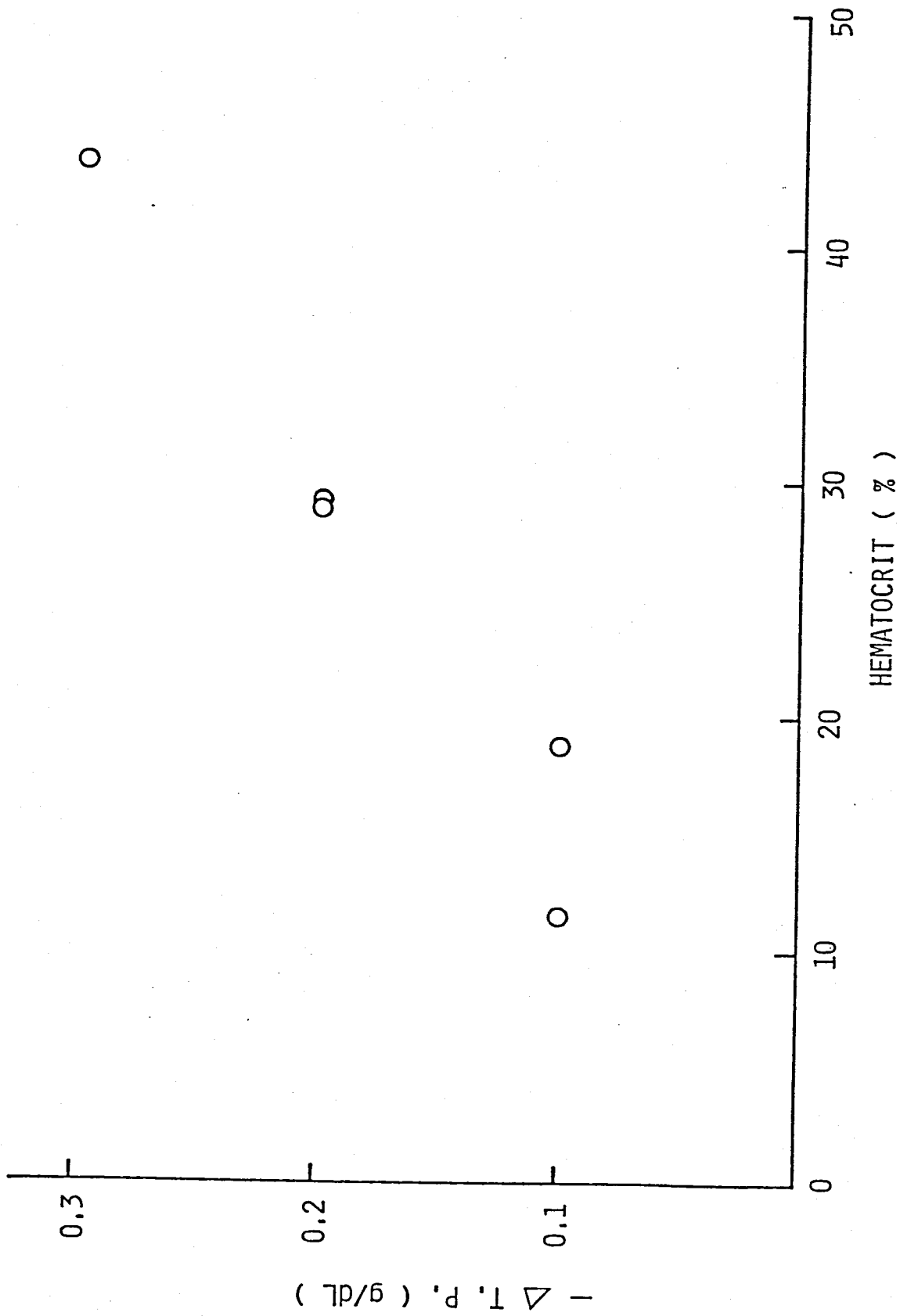

Fig. 6-2. Decreases in the total protein concentration (T.P.) in the plasma due to the additions of different amounts of RBCs washed with saline.

result of the measurement of colloid osmotic pressure (COP) of blood. COP of blood, which results from the thermal motions of proteins in plasma, gives another measure of the protein concentration in the plasma. As shown in Fig. 6-3, COP decreases markedly with increasing ionic osmolarity of the medium, being consistent with the reduction in the protein concentration observed in the former two experiments. A part of the reduction is due to the plasma dilution just the same to the other cases. The decrease in COP is great between 300 and 400 mOsmol, showing a similar tendency to that in T.P. seen in Fig. 5-7. A reduction of 1 mmHg in COP around the normal level corresponds to about 0.2 g/dl decrease in T.P. in the medium. The results given in Fig. 6-3, which were obtained in blood samples with hematocrit 10 %, indicate a greater protein adsorption even compared to the estimation from the T.P. measurement. This difference might be interpreted as the following. Since COP is generated from the thermal motions of proteins, a weak restriction of the mobility of proteins may result in a big change in COP. Further, COP was measured directly on the blood samples without centrifuging them. Therefore, it may be supposed that there might be a greater number of proteins which are so weakly bounded to RBCs that they are easily removed during the centrifugation of blood samples. Such weakly bounded proteins would cause a big reduction in COP and probably be undetectable by the methods requiring the centrifugation of samples.

As suggested by the above arguments, the amount of adsorbed

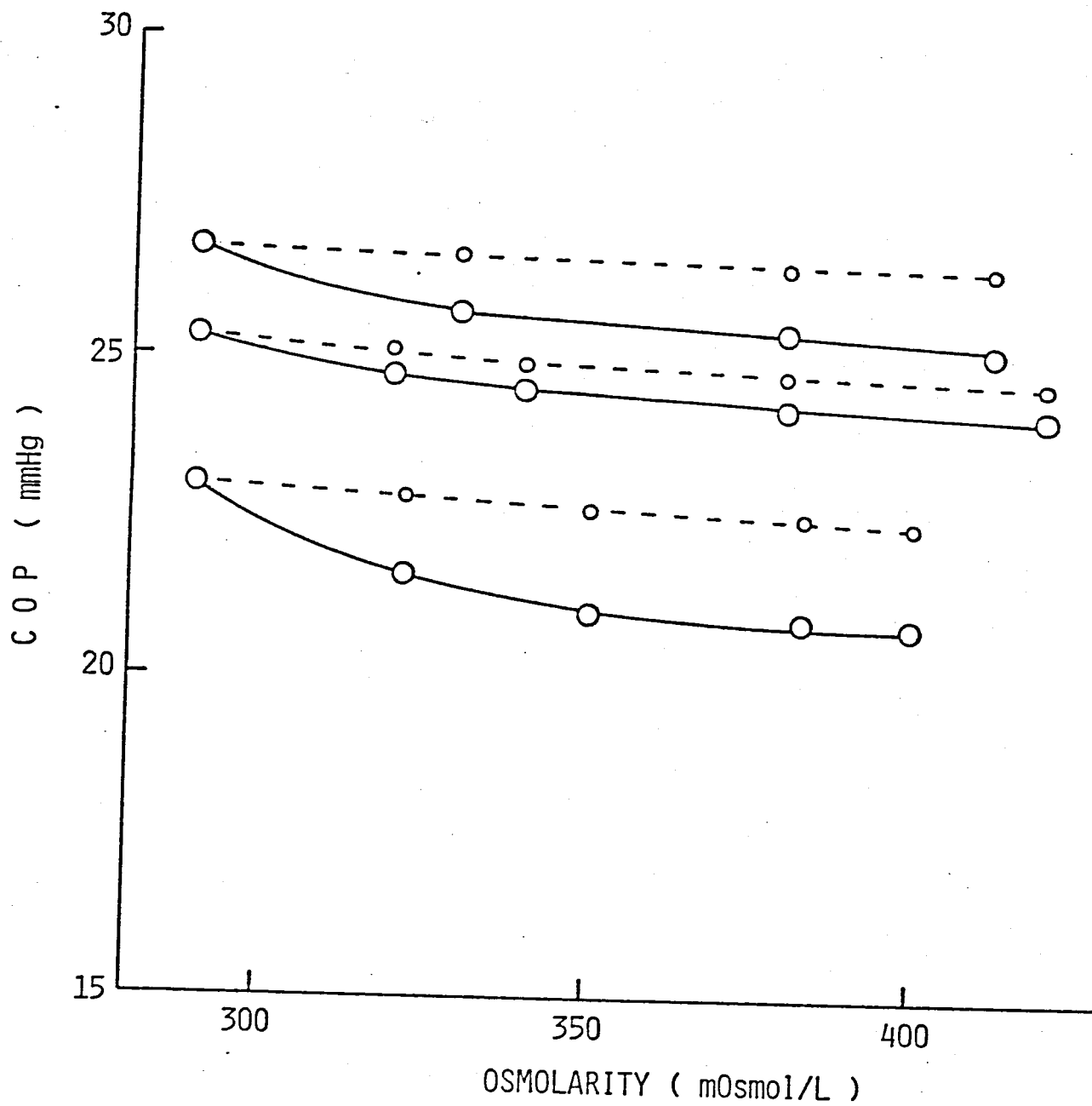
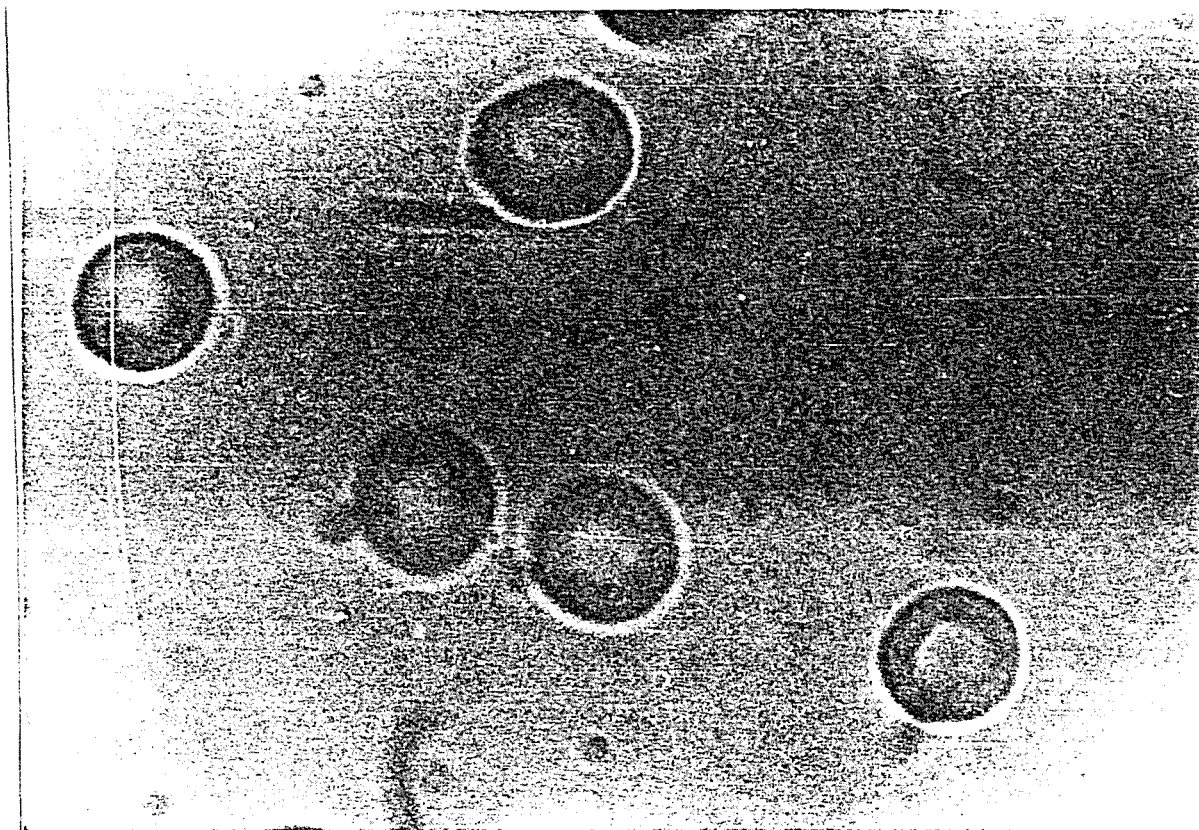
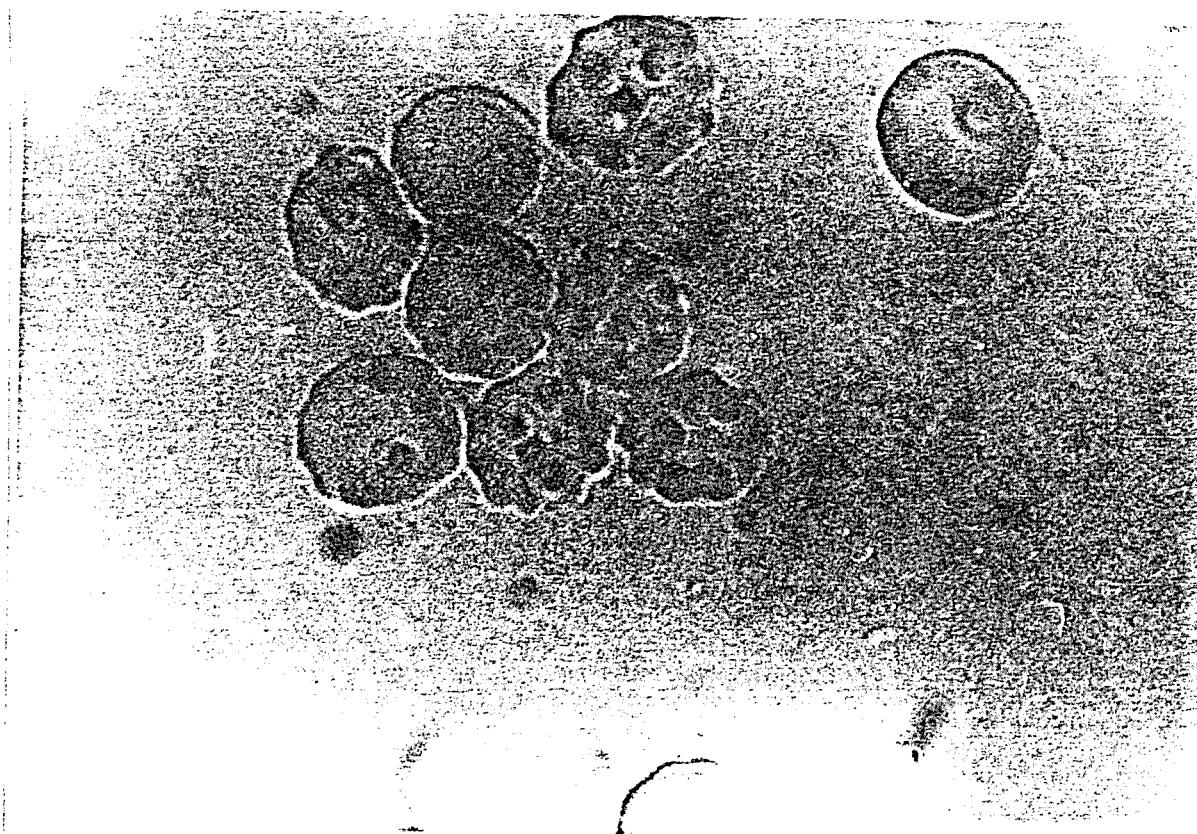

Fig. 6-3. Changes in the colloid osmotic pressure (COP) of PD samples (Hct 10 %) with increasing ionic osmolarity.

proteins to RBCs at normal osmolarity would be a little greater than the estimate from the radiation counts and probably be close on the number of proteins which can form a single protein layer covering the whole surface of a red cell. Further, this amount would be doubled at 400 mOsmol or higher osmolarities. This protein layer formed on the surface of a red cell may well be supposed to protect the red cell membrane against destructive forces on the one hand and to restrict the red cell membrane flexibility on the other hand. A restricted cell membrane flexibility seems to be a main cause of the hyperosmotic reduction in RBC deformability as discussed before. It should be noted that RBCs maintain their normal shape in the hyperosmotic media up to 450 mOsmol. When the osmolarity was elevated above this level, the cell shape was altered from normocyte to echinocyte (Fig. 6-4). A marked reduction in RBC deformability was accompanied with this alteration in the cell shape. A steep increase was seen in the pore passage time of RBCs above 450 mOsmol even in SD samples of hematocrit 10 % (Fig. 5-5, Fig. 6-5). Many factors including the cell geometry and internal viscosity will be complicatedly involved in the marked reduction in the deformability of RBCs exposed to strong hyperosmolarity which inevitable induces the cell shape alteration, while the cell membrane factor seems to be dominant in the reduced deformability of RBCs exposed to mild hyperosmolarity.



RBCs at 450 mOsmol



RBCs at 600 mOsmol

Fig. 6-4. Red cell shapes in the hyperosmotic media.

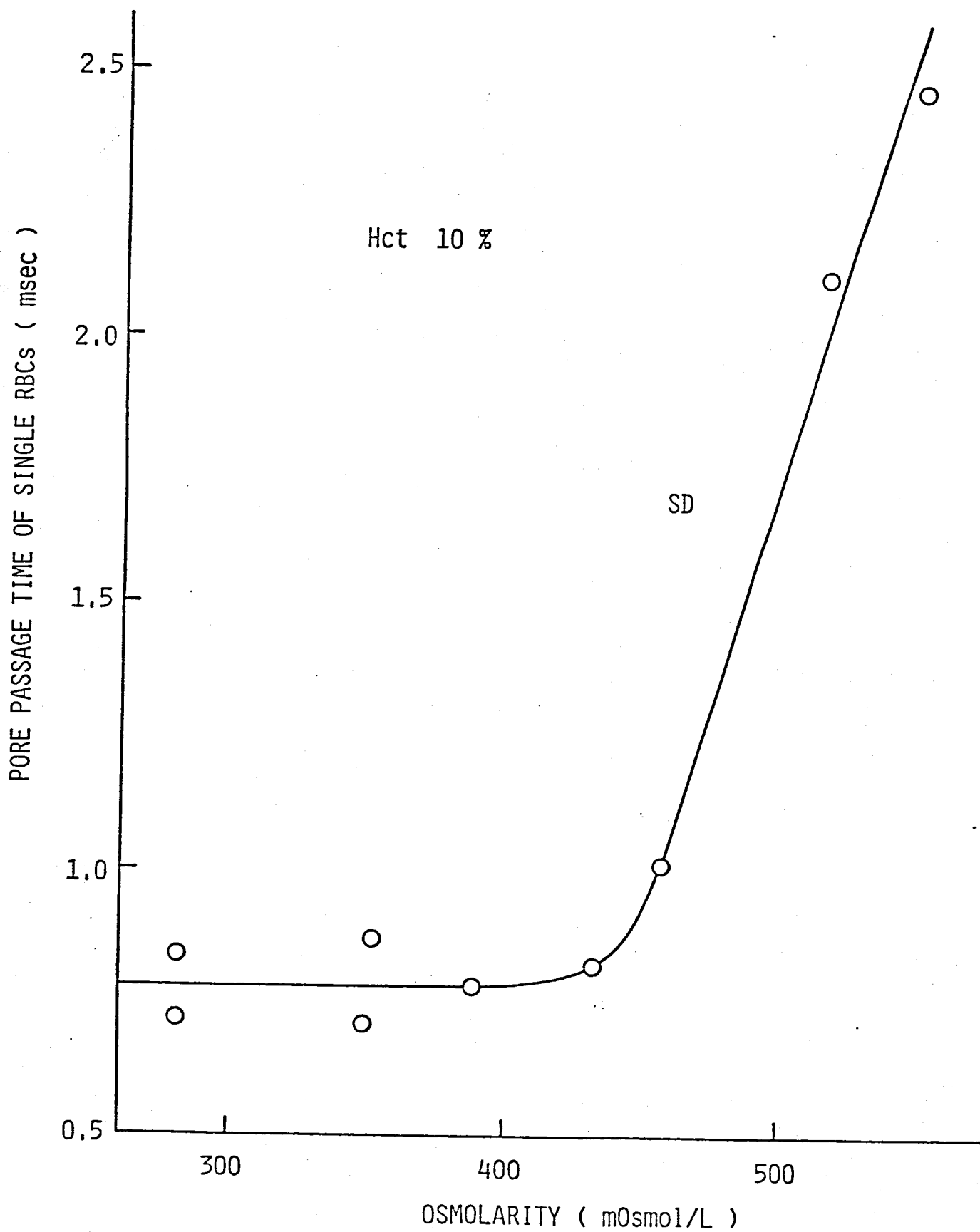

Fig. 6-5. Changes in the pore passage time of single RBCs in SD samples of hematocrit 10 % with increasing ionic strength of the media

7. Roles of Na^+ and K^+ ions in the red cell membrane functions

a) Role of the protein adsorption in RBC passage through a 3 μm pore

The adsorption of plasma proteins to the RBC surfaces causes a reduction in the deformability of RBCs, presumably because the red cell membrane flexibility is restricted by the adsorbed proteins. This effect of plasma proteins on RBCs seems to be rather negative for the benefit of the blood flow through capillary vessels. On the other hand, positive effects of plasma albumin on RBCs have been reported with respect to hemolysis due to hypoosmolarity or mechanical stresses; an addition of a small amount of albumin to RBC suspensions in saline causes an increase in the strength of red cell membrane against destructive forces. This positive aspect of the RBC-protein interactions was observed in the experiment measuring the passability of RBCs through 3 μm pores. The time course of the passage of a RBC through a 3 μm pore is schematically shown in Fig. 7-1. Compared to the case of 5 μm pores (Fig. 3-8), RBCs must deform to a much greater extent to pass through the 3 μm pores. The passability of RBCs decreased quickly with time when RBCs were suspended in saline (Fig. 7-2). While the passability was stable when RBCs were suspended in plasma. No rapid changes were detectable in the case of passage through 5 μm pores even in RBCs suspended in saline within 2 hours after blood sampling.

It has been observed by many researchers that alterations in the red cell shape proceed quickly with time in RBCs suspended in

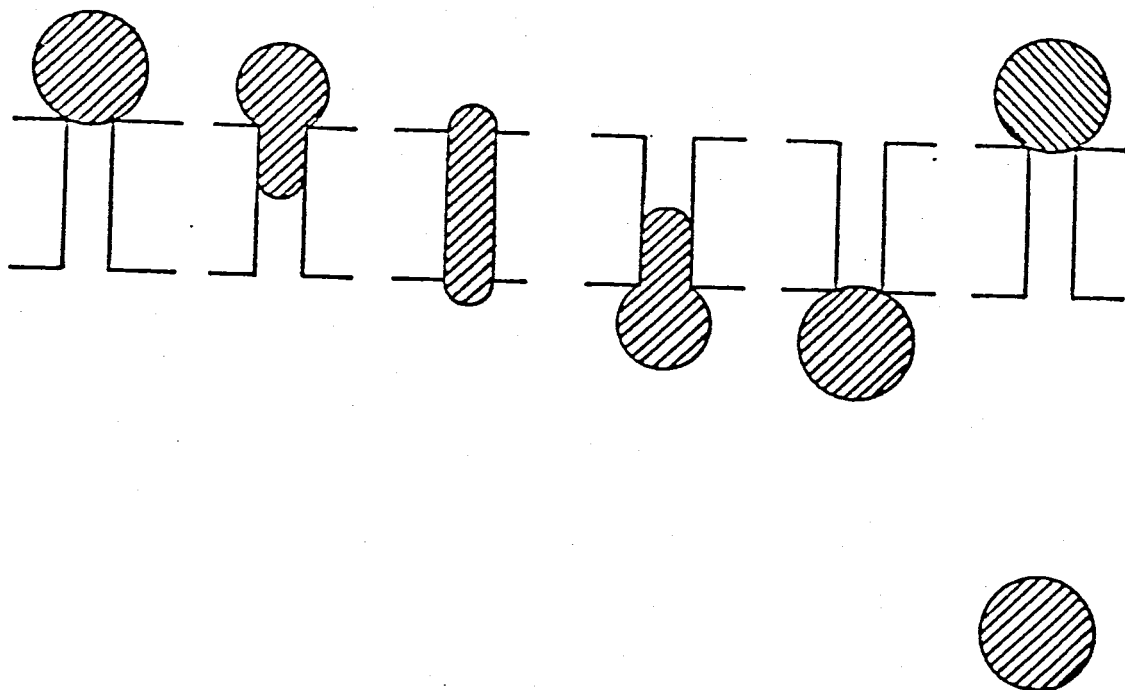

Fig. 7-1. A schematic representation of the passage of a RBC through a pore of $3 \mu\text{m}$ in diameter.

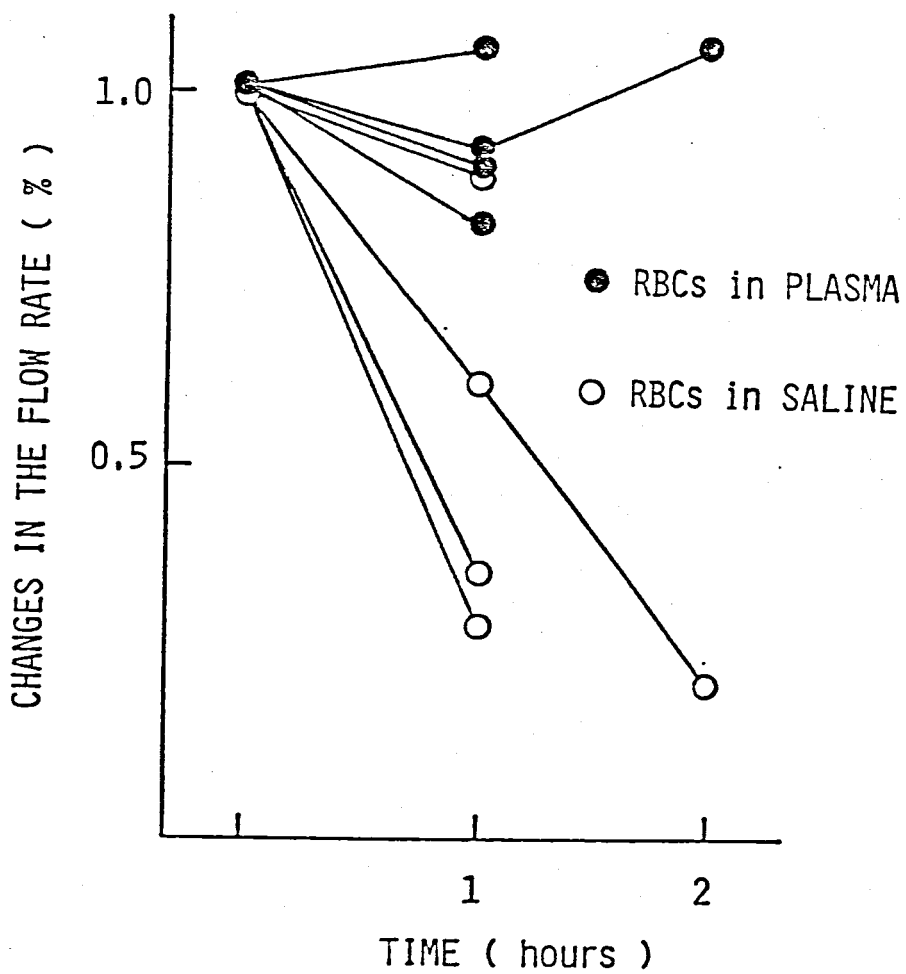

Fig. 7-2. Percent changes in the flow rate of RBC suspensions in plasma and in saline with time.

saline even under static conditions. The cell shape alterations which are not caused by mechanical stresses indicate that some structural changes in the red cell membrane take place with time. The possibility of rearrangement of membrane proteins and mobility of the proteins in the membrane are involved in the fluid mosaic model of the membrane structure of Singer and Nicolson (1972). If the structural changes in the red cell membrane are responsible for the rapid decrease in the passability of RBCs through 3 μ m pores, then it is indicated that the structures in the cell membrane are protected from the destruction by the plasma. The following consideration might be possible. The red cell membrane is forced to deform to a much greater extent during the passage through a 3 μ m pore. The deformability of the membrane to a large extent will be sensitively influenced by the local changes in the membrane structure such as aggregations of neighboring proteins in the membrane. Such structural changes in the red cell membrane may take place quickly in RBCs suspended in saline but not in RBCs in plasma. Therefore the passability of RBCs through 3 μ m pores decreases quickly in saline but it remains constant in plasma. The difference in the stability of the cell membrane structure in the both cases may be attributable to that in the cellular metabolic states. The depletion of ATP proceeds in RBCs suspended in saline since the medium contains no glucose. It has been shown that the depletion of ATP causes a reduction in RBC deformability (Weed et al., 1969) and alterations in the cell shape (Nakao, 1974). While the ATP

level will be maintained in RBCs suspended in plasma, keeping the deformability and cell shape constant with time. However, the reduction in the passability of RBCs through 3 μm pores seems to proceed more quickly than expected from the time course of reduction in the cellular ATP level (Weed et al., 1969; Nakao, 1974).

As has been shown in the previous sections, the protein layer on the red cell surface significantly affects the deformability of RBCs. It might be possible to suppose that this protein layer may prevent movements of membrane proteins in the red cell membrane. Then, the structural changes in the membrane become much dependent on whether the protein layer exists or not. This consideration seems to be able to explain the results given in Fig. 7-2. It seems probable that the protein layer on the red cell surface not only protects the cell membrane against destructive forces but prevents structural changes in the cell membrane. Thus, the adsorption of plasma proteins to RBCs may play a significant role in maintaining the red cell membrane functions.

b) Roles of Na^+ and K^+ ions in controlling the adsorption of proteins to the red cell membrane

The excess amount of NaCl in the medium modifies the interactions between the red cell membrane and plasma proteins to cause an increase in the amount of adsorbed proteins. As the next step it seems very interesting to study the effect of another biologically active monovalent cation K^+ on the cell membrane-protein interact-

ions. The distribution of Na^+ and K^+ ions around the red cell membrane may play a special role in controlling the adsorption of plasma proteins to the red cell membrane. In order to study the effect of K^+ ions, the distribution of ^{131}I human serum albumin was studied in RBC suspensions in the plasma whose osmolarity was elevated by adding KCl instead of NaCl. The radiation counts from the separated RBC portions were almost constant with osmolarity as shown in Fig. 7-3, being in a striking contrast to the results obtained in RBC suspensions in NaCl induced hyperosmotic plasma (Fig. 6-1, also given in this figure for comparison). No increase in the adsorption of plasma proteins to RBCs was induced by an addition of KCl to the plasma. Similar results were obtained from the measurement of T.P. in RBC suspensions in plasma which was hyperosmotic due to experimentally increased concentrations of NaCl and/or KCl. The T.P. detectable in the fluid media decreased with increasing osmolarity but only to the level expected from the plasma dilution due to the water shift from RBCs to plasma in the case of KCl induced hyperosmotic suspensions (as already discussed in the previous sections, the T.P. decreased beyond this dilution level in the case of NaCl induced hyperosmotic suspensions). Namely, the both results of the radiation count and T.P. indicate that the adsorption of plasma proteins to RBCs increases in the NaCl-hyperosmotic suspensions but that no increase in the protein adsorption occurs in the KCl-hyperosmotic suspensions. It is clear from these results that an increment in the Na^+ ion concentration in the medium increases the inter-

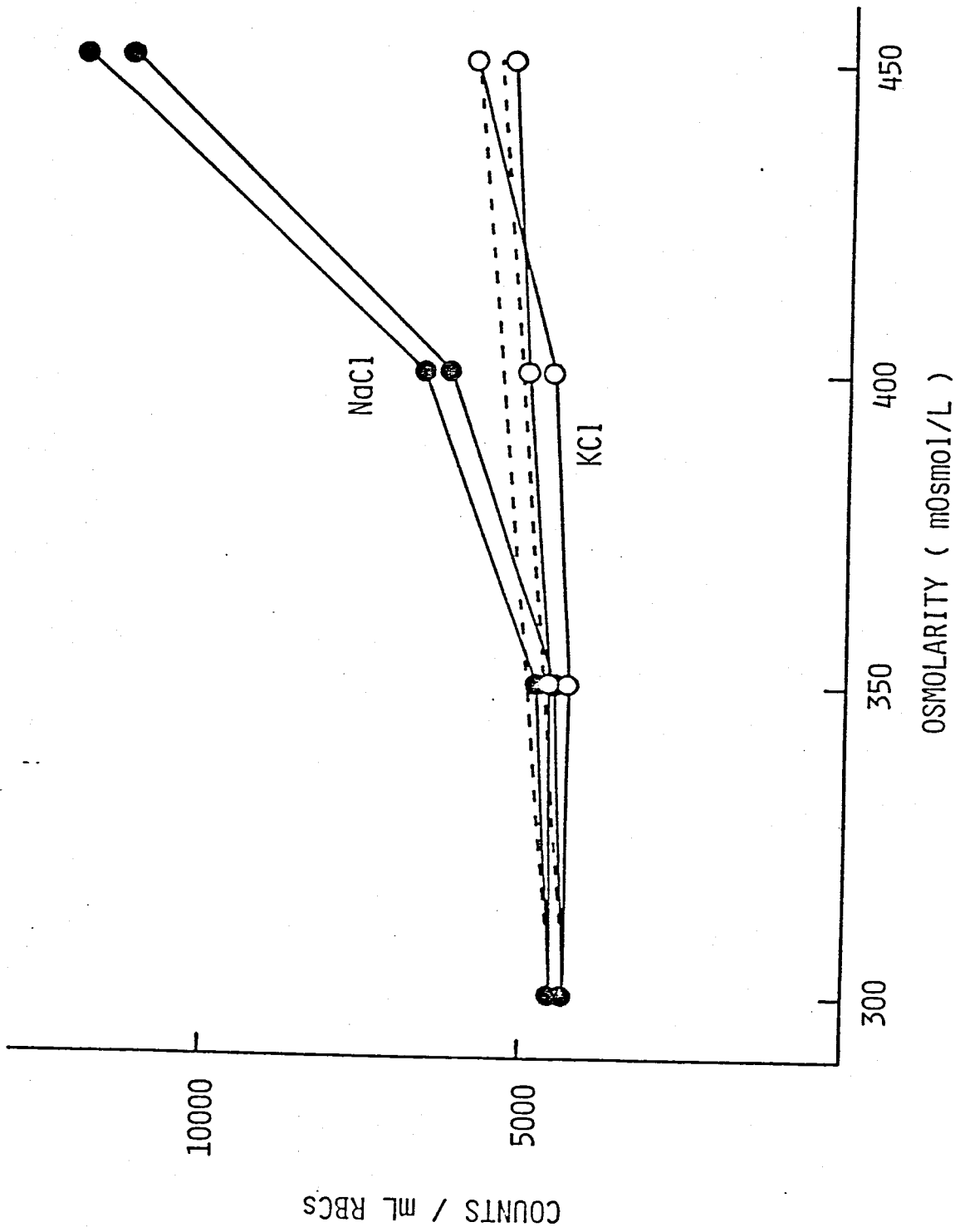

Fig. 7-3. Changes in the radiation count from the separated RBC portions from the blood samples containing ^{131}I human serum albumin. The ionic strengths were increased by adding NaCl and KCl, respectively.

actions between the red cell membrane and plasma proteins but that any increment in the K^+ ion concentration shows no effect to increase the interactions. This finding suggests that the distributions of Na^+ and K^+ ions in the both sides of the red cell membrane may contribute to controlling the adsorption of plasma proteins to the outer surface of the cell membrane and probably to restricting the interactions between the inner surface of the membrane and intracellular hemoglobin.

As shown in the above, the control of the amount of adsorbed proteins may presumably be important for maintaining the red cell membrane functions and its flexibility against mechanical stresses acting on the membrane. Further, if highly concentrated hemoglobin in a RBC are adsorbed to the inner surface of the cell membrane in a similar fashion to the adsorption of plasma proteins to the outer surface, the cell membrane flexibility will be much severely restricted. Therefore, the controlling of the adsorption of plasma proteins to the outer surface of the red cell membrane and the restriction of the adsorption of intracellular hemoglobin to the inner surface of the cell membrane are critically important for maintaining the deformability of RBCs. The distributions of Na^+ and K^+ ions around the red cell membrane contribute to controlling and restricting the adsorption of proteins to the cell membrane at the both surfaces. It has been known that the Na^+-K^+ exchange pumps exist in the red cell membrane and that the pumps consume energy to maintain the concentrations of Na^+ and K^+ ions in the both sides of the cell membrane.

As a result of the active transport of Na^+ and K^+ ions, the protein adsorption is controlled at the outer surface of the cell membrane and minimized at the inner surface. This performance may be an advantageous side effect of the Na^+ - K^+ exchange pumps in the red cell membrane.

Furthermore, the following speculation might be possible. More active blood cells such as lymphocytes or platelets may make positive use of this assumed mechanism to control the adsorption of proteins to their cell membranes. These blood cells alter their shapes rapidly in response to stimulations. A sudden change in the microviscosity of the lipid bilayer of the cell membrane occurs so that the mobility of membrane proteins increases (KATAOKA et al., 1980). Then the membrane proteins aggregate with each other, finally resulting in an alteration of the cell shape. However, it seems difficult to suppose the mechanism to change the microviscosity of the lipid bilayer rapidly at a constant temperature. As discussed above, the mobility of membrane proteins will be restricted by adsorbed proteins to the membrane. If the ion distribution changes rapidly to cause a release of adsorbed proteins, then the mobility of membrane proteins will increase. This speculation seems to be more probable for the fluidity change in the cell membrane, since the ion distribution can be controlled by the Na^+ - K^+ exchange pumps.

Thus, the present study shows that the interactions between the red cell membrane, plasma proteins and ions may play important roles

in the regulation of RBC deformability and in maintaining the red cell membrane functions and further suggests that such interactions between the cell membranes, plasma proteins and ions might be also involved in the deformability or in the cell shape alteration of white blood cells and platelets.

Finally an implication which seems to be of clinical importance must be mentioned. When dehydration proceeds pathologically or by hard exercise, the protein and sodium concentrations in plasma increase considerably. This causes an increase in the adsorption of plasma proteins to RBCs. RBC deformability may decrease and cause an insufficiency in the microcirculation.

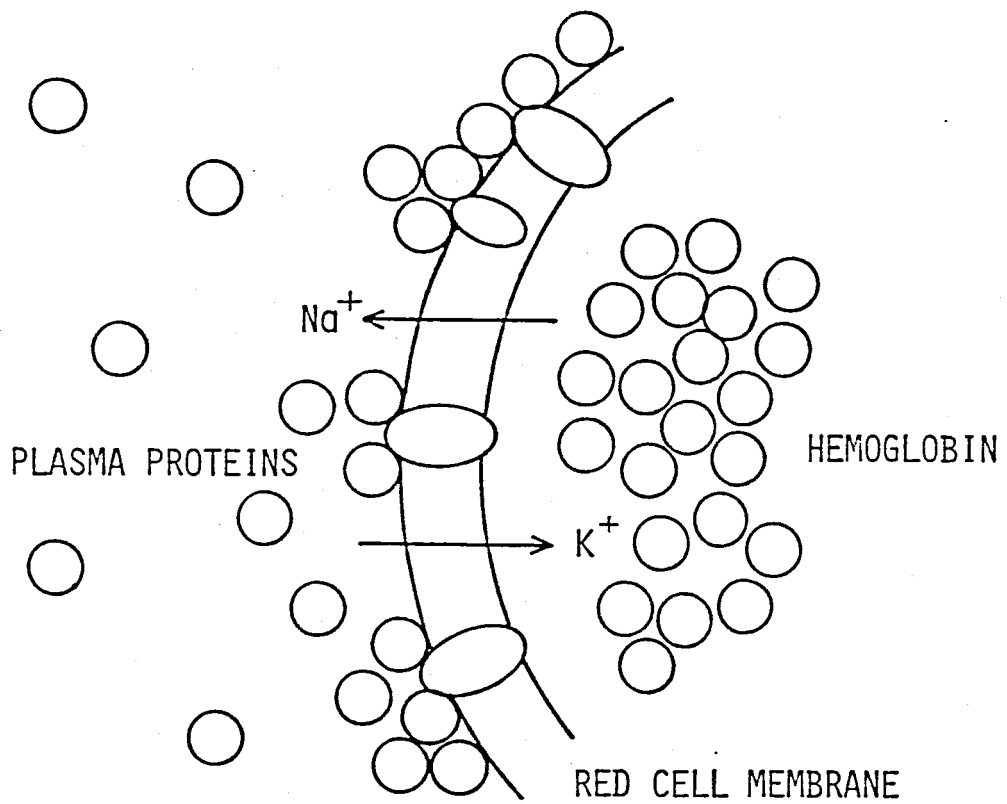

STABILITY IN THE RED CELL SHAPE
and HIGH DEFORMABILITY

Fig. 7-4. Effects of Na^+ and K^+ ions on the protein adsorption to the red cell membrane (schematic representation).

8. APPENDIX

a) Electric diffuse double layer around a red blood cell

Positive ions of charge ze and negative ions of charge $-ze$ distribute in a field of electric potential ψ according to the Boltzmann distribution;

$$N_{\pm} = N_0 \exp(\mp ze\psi/kT) = N_0 \exp(\mp \phi) \quad (\text{A-1}),$$

where N_0 is the number of each ionic species in a unit volume in the region of $\psi=0$. ϕ is defined by

$$\phi = ze\psi/kT \quad (\text{A-2}).$$

The charge distribution q in the field is given by

$$q = ze(N_+ - N_-) \quad (\text{A-3}).$$

ψ and q must satisfy the Poisson equation;

$$\Delta\psi = -q/\epsilon_r\epsilon_0 \quad (\text{A-4}),$$

where ϵ_0 is the permittivity of vacuum and ϵ_r is the relative permittivity of the solution. Putting the equations (A-1) through (A-3) into the equation (A-4), the Poisson-Boltzmann equation

$$\Delta\phi = \kappa^2 \sinh\phi \quad (\text{A-5})$$

is obtained. κ is called the Debye-Hückel constant, which is defined by

$$\kappa^2 = 2N_0 z^2 e^2 / \epsilon_r \epsilon_0 kT \quad (\text{A-6}).$$

The equation (A-5) can be approximated by the Debye-Hückel equation;

$$\Delta\phi = \kappa^2 \phi \quad (\text{A-7})$$

when $\phi \ll 1$. The electric potential due to the charges on the surface of a colloid particle can be calculated from the equation (A-5) or

approximately from the equation (A-7) using the boundary condition of

$$d\psi/dx|_{x \rightarrow +0} = -\sigma/\epsilon_r \epsilon_0 \quad (\text{A-8}),$$

where x is the direction normal to the surface with the positive direction taken outward from the surface. σ is the surface charge density. The potential decreases within the length of the order of κ^{-1} from the surface; the potential decreasing region is called electric diffuse double layer.

The red cell surface can be regarded as a semi-infinite plate since the radius of curvature of the surface is much greater than the thickness of the electric diffuse double layer; the one dimensional Poisson-Boltzmann equation can be used to calculate the electric potential due to the surface charges. The integration of the equation gives

$$d\phi/dx = -2\kappa \sinh(\phi/2) \quad (\text{A-9}).$$

The integration of this equation must be done numerically. Examples of the calculation are shown in Fig. A-1, where a constant surface potential is taken as the boundary condition.

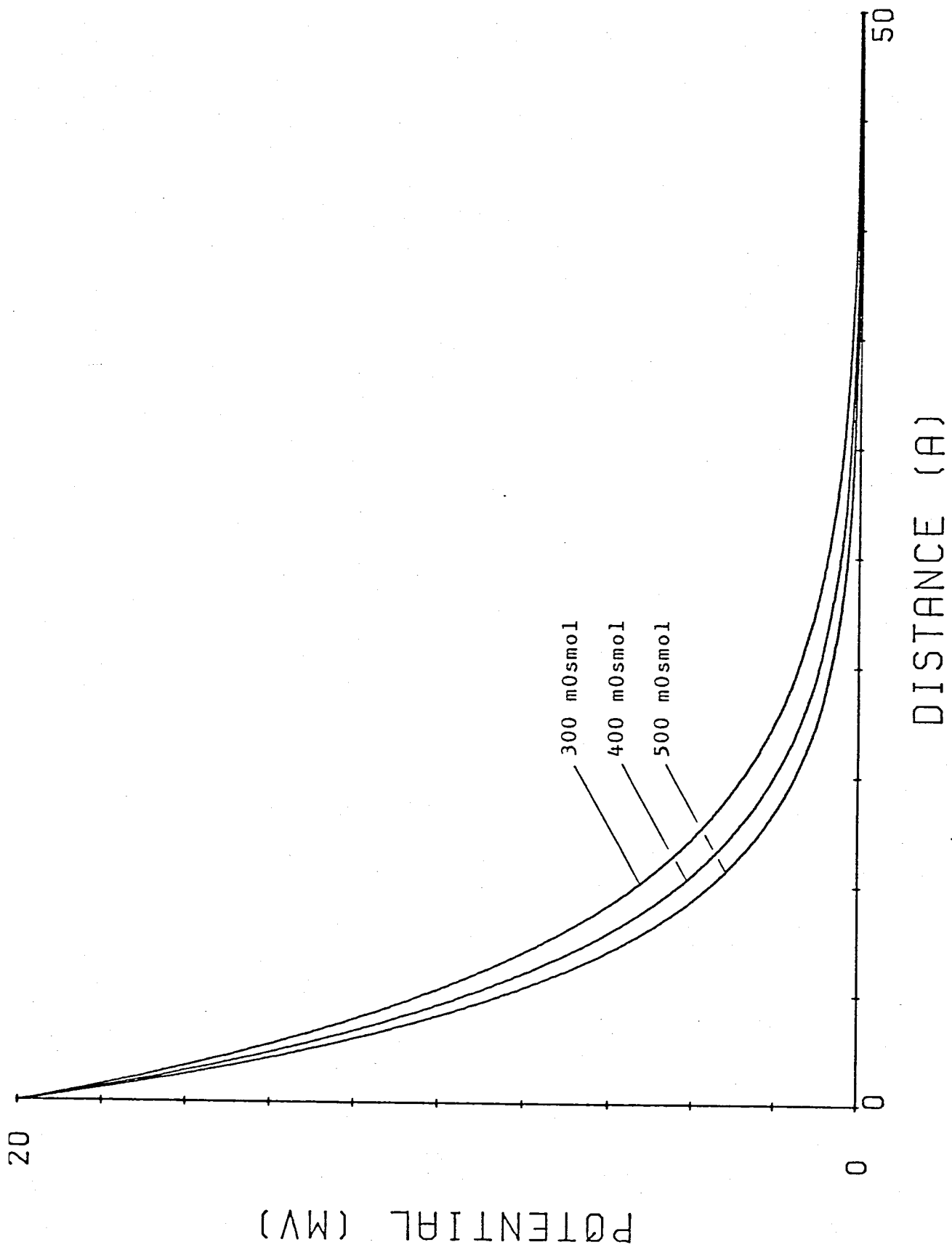

Fig. A-1. Electric potential : decay in the diffuse double layer.

b) van der Waals interaction

The van der Waals interaction between the red cell surface and an albumin molecule may be treated as the one between a semi-infinite plate and a sphere (Fig. A-2). The interaction energy is given by integrating

$$V_a = -A \int_{V_1} \int_{V_2} (1/Y^6) dV_1 dV_2 \quad (A-10),$$

where A is the Hamaker constant. The integration can be made as the following using the notations given in Fig. A-2.

$$\begin{aligned} V_a &= -A \int dV_1 \int_0^\infty \int_0^\infty \frac{2 R dR dx}{\ell (R^2 + x^2)^3} \\ &= -\frac{\pi A}{2} \int dV_1 \int_\ell^\infty \frac{dx}{x^4} \\ &= -\frac{\pi A}{6} \int \frac{1}{\ell^3} dV_1 \\ &= -\frac{\pi A}{6} \int_0^a \int_0^\pi \int_0^{2\pi} \frac{1}{(d+r \cdot \cos \theta)^3} r^2 \sin \theta dr d\theta d\phi \\ &= -\frac{\pi^2 A}{3} \int_0^a \int_1^{-1} \frac{1}{(d+r \cdot \cos \theta)^3} r^2 dr d(-\cos \theta) \\ &= -\frac{\pi^2 A}{6} \int_0^a \left(\frac{1}{(d-r)^2} - \frac{1}{(d+r)^2} \right) r dr \\ &= -\frac{\pi^2 A d}{3} \int_0^a \frac{2r^2 dr}{(d^2 - r^2)^2} \\ &= -\frac{\pi^2 A d}{3} \int_0^a rd \left(\frac{1}{d^2 - r^2} \right) \\ &= -\frac{\pi^2 A d}{3} \left(\frac{a}{d^2 - r^2} - \int_0^a \left(\frac{1}{d+r} + \frac{1}{d-r} \right) dr \right) \\ &= -\frac{\pi^2 A}{3} \left(\frac{da}{d^2 - a^2} - \frac{1}{2} \ln \frac{d+a}{d-a} \right) \quad (A-11). \end{aligned}$$

The final result shows that the van der Waals interaction energy between a semi-infinite plate and a sphere is of the same order with

A at distances of the order of the diameter of the sphere. The Hamaker constant A for the lipid/water system has been reported to be $10^{-20} \sim 10^{-21}$ Joule. A potential curve calculated from (A-11) is shown in Fig. A-3.

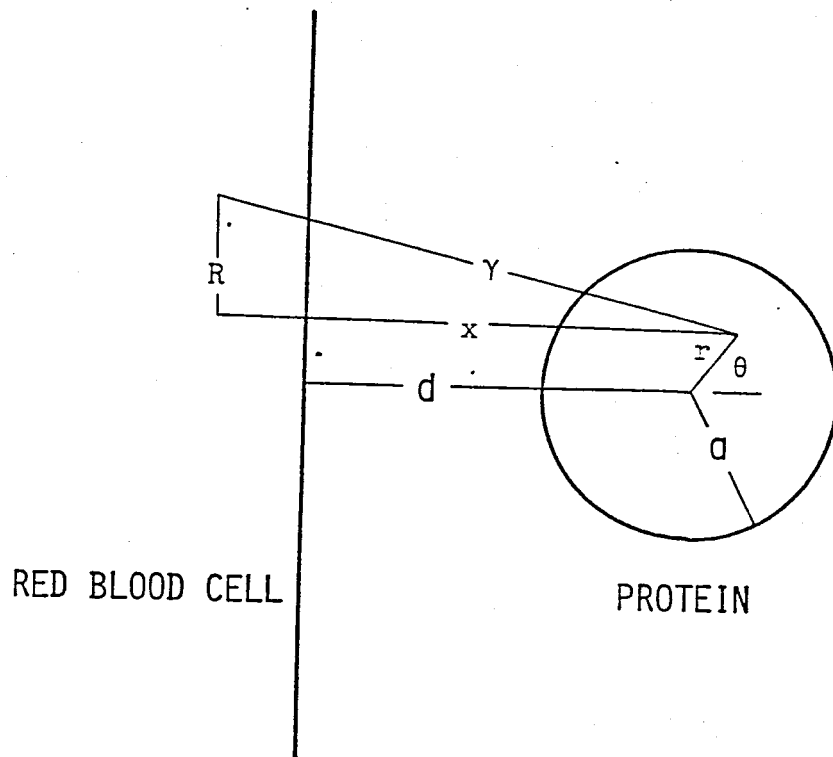

Fig. A-2.

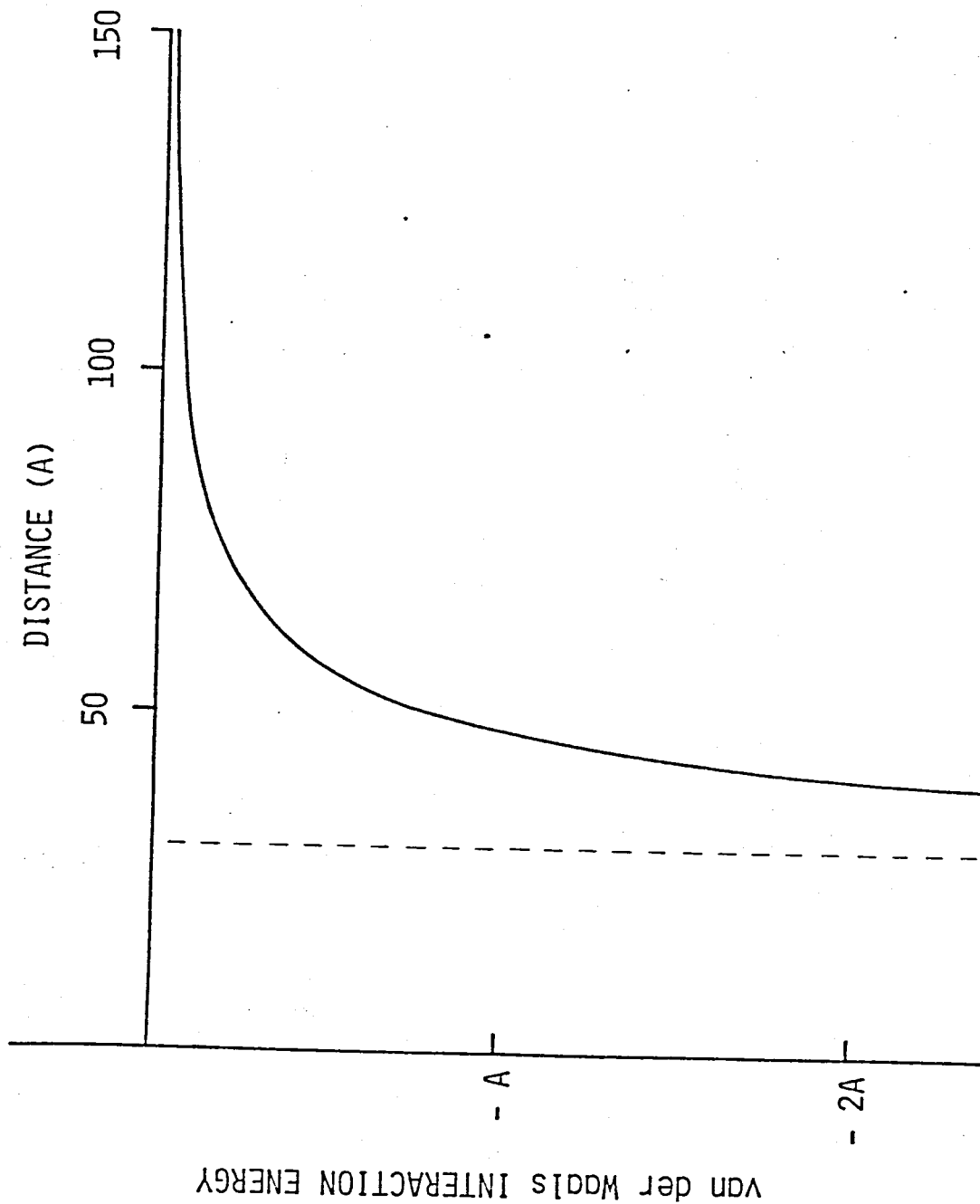

Fig. A-3. van der Waals interaction energy between a semi-infinite plate and a sphere. The distance is taken from the surface of the plate to the center of the sphere (radius 30 A).

REFERENCES

- Bagge, U., Skalak, R. and Attefors, R. (1977) Granulocyte rheology. *Adv. Microcirc.* 7, 29-48.
- Bessis, M. and Mohandas, N. (1975) A diffractometer method for the measurement of cellular deformability. *Blood Cells*, 1, 307-313.
- Bull, B. S. and Brailsford, J. D. (1975) The relative importance of bending and shear in stabilizing the shape of the red blood cell. *Blood Cells*, 1, 323-331.
- Caro, C. G., Pedley, T. J., Schroter, R. C. and Seed, W. A. (1978) *The Mechanics of the Circulation*. Oxford Univ. Press, Oxford-New York-Toronto.
- Chien, S., Luse, S. A. and Bryant, C. A. (1971) Hemolysis during filtration through micropores. A scanning electron microscopic and hemorheologic correlation. *Microvasc. Res.* 3, 183-302.
- Cokelet, G. R. and Meiselman, H. J. (1968) Rheological comparison of hemoglobin solutions and erythrocyte suspensions. *Science* 162, 275-277.
- Derjaguin, B. V. and Landau, L. D. (1941) *Acta Physicochim.* 14, 633.
- Dintenfass, L. (1968) Internal viscosity of the red cell and a blood Viscosity equation. *Nature* 219, 956-958.
- Dintenfass, L. (1977) Theoretical aspects and clinical applications of the blood viscosity equation containing a term for the internal viscosity of the red cell. *Blood Cells* 3, 367-374.
- Ehrly, A. M. (1978) The effect of pentoxifylline on the flow proper-

- ties of human blood. *Curr. Med. Res. Opin.* 5, 608-613.
- Fung, Y. C. (1966) Theoretical considerations of the elasticity of red cell and small blood vessels. *Fed. Proc.* 25, 1761-1772.
- Fung, Y. C. (1977) Red blood cells and their deformability. *Microcirculation*. Gabor, K. and Burton, M. A., eds., University Park Press, Baltimore-London-Tokyo.
- Gregersen, M. I., Brayant, C. A., Hammerle, W. E., Usami, S. and Chien, S. (1967) Flow characteristics of human erythrocytes through polycarbonate sieves. *Science* 157, 825-827.
- Haydon, D. A. and Seaman, G. V. F. (1967) Electrokinetic studies on the ultrastructure of the human erythrocyte I. Electrophoresis at high ionic strengths - the cell as a polyanion. *Arch. Biochem. Biophys.*, 122, 126-136.
- Haydon, D. A. and Taylor, J. S. (1968) Contact angles for thin lipid films and the determination of London-van der Waals forces. *Nature* 217, 739-740.
- Hochmuth, R. M., and Mohandas, N. (1972) Uniaxial loading of the red-cell membranes. *J. Biomech.* 5, 501-510.
- Hoerber, T. W. and Hochmuth, R. M. (1970) Measurement of red blood cell modulus of elasticity by in-vitro and model cell experiments. *Trans. ASME, Ser. D., Basic Eng.* 92, 604.
- Kakiuchi, Y., Arai, T., Horimoto, M., Kikuchi, Y. and Koyama, T. (1979) A new needle-type colloid osmometer for continuous determination of blood oncotic pressure. *Amer. J. Physiol.* 236(4), F419-F422.

- Katchaldky, A., Kedem, O., Klibansky, C. and de Vries, A. (1960) Flow Properties of Blood and Other Biological Systems. Copley, A. L. and Stainly, G., eds., Pergamon, New York, 155-171.
- Kataoka, K., Okano, T., Akaike, T. and Sakurai, Y. (1980) Bioseparator. Biomedical Polymer. Kagaku Dojin, Tokyo, 79-88.
- Kikuchi, Y., Horimoto, M. and Koyama, T. (1979) Reduced deformability of erythrocytes exposed to hypercapnia. *Experientia* 35, 343-344.
- Kikuchi, Y., Horimoto, M., Koyama, T., Koyama, Y. and Tozawa, S. (1980) Estimation of pore passage time of red cells in normal subjects and patients with renal failure. *Experientia*, 36, 325-326.
- Kikuchi, Y. and Koyama, T. (1981) Role of protein adsorption in micropore passability of red cells. *Jpn. J. Physiol.* in press.
- Kikuchi, Y., Koyama, T., Koyama, Y., Tozawa, S., Arai, T., Horimoto, M. and Kakiuchi, Y. (1981) Red blood cell deformability in renal failure. *Nephron* in press.
- Nakao, M. (1974) ATP-requiring phenomena in red-cell membranes. Cellular and Molecular Biology of Erythrocytes. Yoshikawa, H. and Rappoport, S. M. eds., Urban & Schwarzenberg, Munchen.
- Ponder, E. (1971) Hemolysis and Related Phenomena. Grune and Stratton Inc. New York.
- Rand, R. P. and Burton, A. C. (1964) Mechanical properties of the red cell membrane. I. Membrane stiffness and intracellular pressure. *Biophys. J.*, 4, 115-135.
- Reid, H. L., Barnes, A. J., Lock, P. J., Dormandy, J. A. and Dormandy,

- T. L. (1976) A simple method for measuring erythrocyte deformability. *J. Clin. Path.*, 29, 855-858.
- Schlick, W. and Schmid-Schönbein, H. (1975) Measurement of single red cell deformability : preliminary report. *Blood Cells*, 1, 333-338.
- Schmid-Schönbein, H., Wells, R. and Goldstone, J. (1969) Influence of deformability of human red cells upon blood viscosity. *Circ. Res.*, 25, 131-143.
- Shiga, T., Maeda, N., Suda, T., Kon, K., Sekiya, M. and Oka, S. (1979) A kinetic measurement of red cell deformability : a modified micropipette aspiration technique. *Jpn. J. Physiol.* 29, 707-722.
- Singer, S. H. and Nicolson, G. L. (1972) The fluid mosaic model of the structure of cell membranes. *Science* 175, 720-731.
- Skalak, R., Tozeren, A., Zarda, P. and Chien, S. (1973) Strain energy function of red blood cell membranes. *Biophys. J.* 13, 245-264.
- Sobin, S. S. and Tremer, H. M. (1977) Three-dimensional organization of microvascular beds as related to function. *Microcirculation*. Gabor, K. and Burton, M. A., eds., University Park Press, Bultimore-London-Tokyo.
- Sunderman, F. W. (1944) A rapid method for estimating serum proteins : formula for calculating serum-protein concentration from the refractive index of serum. *J. Biol. Chem.*, 153, 139-142.
- Teitle, P. (1965) Disk-sphere transformation and plasticity alteration of red blood cells. *Nature*, 206, 409-410.

- Tsushima, N., Satoh, T. and Koyama, T. (1981) Human microcirculation (MC) by intravital microscopic system (IVVMS). *Bibliotheca anat.*, 20, 716-719.
- Verwey, E. J. W. and Overbeek, J. Th. G. (1948) *Theory of the Stability of Lyophobic Colloids.* Elsevier, Amsterdam.
- Weed, R. I., LaCelle, P. L. and Merrill, E. W. (1969) Metabolic dependence of red cell deformability. *J. Clin. Invest.*, 48, 795-809.
- Williams, A. R. (1973) The effect of bovine and human serum albumins on the mechanical properties of human erythrocyte membranes. *Biochim. Biophys. Acta*, 307, 58-64.
- Yoshikawa, H. (1947) Physico-chemical analysis of serum protein concentration. *Nisshin Igaku*, 34, 6-11.

ACKNOWLEDGEMENTS

I wish to express my hearty thanks to Professor T. Koyama for giving me a number of useful suggestions and stimulating discussions throughout this work and to Professor M. Date, Osaka University, Professor Y. Yokozawa and Professor I. Tatsuzaki for encouraging me to work in this field of biology and physiology. I am much grateful to Dr. K. Katsumata for continual encouragements; to Dr. T. Ohnishi, Isotope Center of Hokkaido University, for many helps in the radio-isotope experiment; to Mr. T. Arai for assistance in developing the method for deformability measurement and Mrs. M. Namikawa for kindly typing the manuscript.

Finally, I would like to thank my wife for her continuous helps and encouragements.