

Title	STUDIES ON THE PHYSICOCHEMICAL PROPERTIES OF ASTATINE AND RADON BY RADIOGASCHROMATOGRAPHY
Author(s)	Takahashi, Naruto
Citation	大阪大学, 1983, 博士論文
Version Type	VoR
URL	<a href="https://hdl.handle.net/11094/24577">https://hdl.handle.net/11094/24577</a>
rights	
Note	

*Osaka University Knowledge Archive : OUKA*

<https://ir.library.osaka-u.ac.jp/>

Osaka University

STUDIES ON THE PHYSICOCHEMICAL PROPERTIES OF ASTATINE  
AND RADON BY RADIOGASCHROMATOGRAPHY

by

Naruto Takahashi

(Thesis)

Department of Chemistry, Faculty of Science,  
Osaka University

January 1983

To know is nothing at all;  
To imagine is everything.

- Anatole France -

## CONTENTS

ABSTRACT .....	6
I. INTRODUCTION	
A. ESTIMATION OF PHYSICOCHEMICAL PROPERTIES OF ASTATINE AND RADON .....	8
B. CHEMICAL PROPERTIES OF ASTATINE AND RADON .....	9
C. RADIOGASCHROMATOGRAPHY .....	10
II. ESTIMATION OF THE CHEMICAL FORM AND THE BOILING POINT OF ELEMENTARY ASTATINE	
A. INTRODUCTION .....	13
B. EXPERIMENTAL PROCEDURE	
B-1. Preparation of Astatine .....	19
B-2. Radiogaschromatographic Apparatus .....	21
B-3. Preparation of Samples for Analysis .....	28
B-4. Analysis of the Samples .....	29
C. RESULTS	
C-1. Plateaus of the Counter .....	30
C-2. Gas Radiochromatograms .....	30
C-3. Estimation of the Boiling Point by Semi-Empirical Theory .....	33
D. DISCUSSION	

D-1.	Assignments of Peaks (Determination of the Chemical Form of Elementary Astatine) .....	35
D-2.	Formation of AtI and the Anomalous Boiling Point of At <sub>2</sub> .....	40
III. ESTIMATION OF THE BOILING POINT OF RADON BY RADIOGASCHROMATOGRAPHY		
A.	INTRODUCTORY CONSIDERATION .....	43
B.	EXPERIMENTAL METHOD	
B-1.	Preparation of Radon and Xenon Samples .....	48
B-2.	Modified RGC System .....	50
B-3.	Analysis of Rn and Xe by RGC .....	53
C.	RESULTS	
C-1.	Estimated Boiling Points of Rn and Xe .....	54
D.	DISCUSSION	
D-1.	Applicability of the Semi-Empirical Theory on Rare Gases .....	57
D-2.	Choice of the Solvent in RGC and Error of the Boiling Point Estimated .....	61
D-3.	Disagreement between the Obtained Boiling Point of Rn and That Given in Literatures .....	64
IV. DISCUSSION ON THE BOILING POINTS OF ASTATINE AND RADON		
A.	EXTRAPOLATION FROM OTHER ELEMENTS IN THE SAME GROUP	
A-1.	Calculation by Otozai's Empirical Formula .....	66

A-2. Relation between the Boiling Point and the Period Number .....	69
B. ON THE SEMI-EMPIRICAL FORMULA BETWEEN BOILING POINTS AND RETENTION VOLUMES IN GAS CHROMATOGRAPHY .....	72
C. CONSIDERATION ON THE BOILING POINT WITH RELATION TO THE EFFECTIVE NUCLEAR CHARGE .....	75
ACKNOWLEDGEMENTS .....	86
REFERENCES .....	87
APPENDIX (i) SEMI-EMPIRICAL THEORY ON THE RETENTION VOLUME IN GAS CHROMATOGRAPHY .....	95
APPENDIX (ii) REACTION MECHANISMS OF ELEMENTARY ASTATINE WITH SOME ORGANIC SOLVENTS .....	106
APPENDIX (iii) DETERMINATION OF THE MOLECULAR WEIGHT AND SOLUBILITY PARAMETERS OF HIGH-POLYMERS BY GAS CHROMATOGRAPHY .	121
REFERENCES FOR APPENDIX .....	126
LIST OF PUBLICATION .....	129

## ABSTRACT

The physicochemical properties of astatine and radon, i.e., the chemical form of elementary astatine and the boiling points of astatine and radon, have been studied by means of a newly designed radiogaschromatography.

Astatine used was synthesized by  $^{209}\text{Bi}({}^3\text{He}, 3n)^{209}\text{At}$  reaction. Astatine zero was extracted into carbon tetrachloride from 1 N  $\text{HNO}_3$  solution, and then it was mixed with the  $^{131}\text{I}_2$  solution which contained a small amount of  $\text{I}_2$  carrier. This sample was analyzed by the radiogaschromatography, and then the boiling points of the peaks observed was estimated by the use of a semi-empirical formula relating the retention volume with the boiling point of an object. Further, the chemical form was determined on the basis of the rule found for the boiling points of diatomic interhalogen compounds. The boiling point of radon was estimated too, after the semi-empirical formula was confirmed by using xenon to hold on rare gases.

The boiling points obtained were  $503 \pm 3$  and  $198 \pm 2$  K for astatine and radon, respectively. These values were

much lower than the extrapolated values from the lighter elements in the same groups, and the boiling point of radon was lower than that obtained by Gray and Ramsay.

The deviation was concluded to be well explained by the Pauling's screening constant on both astatine and radon.



## I. INTRODUCTION

### A. ESTIMATION OF PHYSICOCHEMICAL PROPERTIES OF ASTATINE AND RADON

As well known astatine and radon are the heaviest elements in halogens and rare gases, respectively, the existence of which has been confirmed until now. It is very difficult to study their physicochemical properties by usual method, because they are short-lived radioisotopes and so only the trace amounts can be dealt with. When gross amounts are treated, various effects due to radioactive disintegration must be considered. Hence, the properties of them have been estimated by many ways. The most popular method is to extrapolate the properties of the elements which belong to the same group as the object. The boiling points[I-1], some critical properties (critical temperature, pressure and volume)[I-2, 3], and ionization potentials [I-4], for example, were estimated by this method. As these values are not confirmed experimentally, there are no guarantees that the extrapolation is possible beyond the

experimental values. Thus it would be far difficult to estimate the properties of eka-astatine and eka-radon, which are very interesting from the standpoint of nuclear chemistry.

#### B. CHEMICAL PROPERTIES OF ASTATINE AND RADON

The chemical behavior of astatine has been investigated by many workers[I-5 to I-7]. The chemical behavior of this element is similar to iodine in general, but it is partly different. It is very important when the element is separated from the target and is purified. When it is artificially synthesized, the element is separated with the consideration of the following behaviors[I-8 to I-11]:

(1) Since astatine has a tendency to be adsorbed on surfaces of glass as many other trace species, precautions must be taken to avoid this cause of error. (2) From solutions, in which astatine is only partially reduced by sulfur dioxide, it is partially carried by thallium iodide, but completely carried by silver iodide. (3) In the presence of iodine, astatine is best isolated by the precipitation of an iodide from a reducing solution, but sometimes silver nitrate does not precipitate astatine from a slightly nitric acid solution using potassium iodide as a carrier. This is

probably due to losses of astatine from the AgI lattice as pointed out[I-12]. Precipitation with PdI from the solution containing sulfite and an excess of nitric acid is more reliable, because palladium iodide recrystallize more slowly than silver iodide[I-13]. (4) Astatine zero is extracted readily from nitric acid solutions into organic solvents such as benzene and carbon tetrachloride. The partition coefficients are rather variable and depends on mainly on the type of impurities present. Most of astatine is extracted into organic solvents can be back-extracted into aquaous phase containing NaOH, because of hydrorysis.

Although radon has been thought to be chemically inactive, there are some evidences that it forms the compounds with halogens like xenon[I-14,15].

### C. RADIOGASCHROMATOGRAPHY

Methods of radiogaschromatography is extraordinarily sensitive. They provide qualitative and quantitative data and require only very small amounts of samples. The technique of radiogaschromatography differs from current gas chromatography only in the detector which records the radioactivity of gaseous mixture and vapours in their exit from the column. The general requirments are the possibility

of measuring radioactivity over a wide range and with sufficient accuracy. These measurements can be carried out discontinuously or continuously in the flow.

The discontinuous (batch) method is very simple procedure and consists in measuring radioactivity of various fractions of the separated substance at the exit of a column. It is used in the case of low specific activities. The eluate is adsorbed on some suitable material. The column should be adjusted to permit the connection of absorption vessels, which are either replaced at regular intervals or after each fraction. Although this method is very sensitive, each radioactive fraction should be collected quantitatively. There are several ways for the collection of sample. Separated fractions are trapped into condenser vessel cooled with a dry-ice or liquid-nitrogen[I-16,17] and are adsorbed on active charcoal, millipore filters and adsorption cotton[I-18].

In the continuous analysis the detectors of radiation are placed in series with the column. An advantage of this method is that the samples are always monitored with fairly high sensitivity. The type of radioactivity detector used is determined by the type of radiation to be detected and the working conditions of analysis (e.g., carrier gas, chemical composition of sample etc.), particularly in the case of flow proportional counter or ionization chamber,

where the eluted gases form directly the functional component of detector.

Radiation detectors used are changed according to the type and energy of the radiation emitted by the detected radionuclides. Though the most suitable detector in the continuous measurement of gamma rays of effluents is a scintillation counter, a proportional counter is suitable to detect beta and alpha rays. In the present study the proportional counter was used.

## II. ESTIMATION OF THE CHEMICAL FORM AND THE BOILING POINT OF ELEMENTARY ASTATINE

### A. INTRODUCTION

Astatine, the heaviest element in the halogens was artificially synthesized for the first time by Corson et al.[II-1]. It was produced in the  $^{209}\text{Bi}(\text{He}, 2n)^{211}\text{At}$  reaction using 32 MeV alpha particles at the Crocker Radiation Laboratory cyclotron. A very large number of astatine isotopes, which have various half-lives ranging from 0.1  $\mu\text{sec}$  to 8.3 h, have been discovered until now as shown in Table II-1. The isotopes of importance in the chemical studies of astatine are  $^{211}\text{At}$ ,  $^{210}\text{At}$  and  $^{209}\text{At}$ , because their half-lives are the most suitable for the treatment of astatine, and other isotopes are of very short life.

Although the chemical properties of the element (e.g., oxidation state, extractability, reactivity etc.) [II-2 to II-5] have been studied since the discovery of the

Table II-1. Isotopes of astatine

Mass	Half life	Decay	Production mode	Reference
196	0.3 sec		$^{185}\text{Re}(^{20}\text{Ne}, 9\text{n})$	II-6
177	0.3 sec		$^{185}\text{Re}(^{20}\text{Ne}, 8\text{n})$	II-6
198	4.9 sec		$^{185}\text{Re}(^{20}\text{Ne}, 7\text{n})$	II-6
199	7.2 sec		$^{185}\text{Re}(^{20}\text{Ne}, 6\text{n})$	II-6
200	42 sec	$\alpha, \text{EC}+\beta^+$	$^{197}\text{Au}(^{12}\text{C}, 9\text{n})$	II-7
201	1.5 m	$\alpha, \text{FC}+\beta^+$	$^{197}\text{Au}(^{12}\text{C}, 8\text{n})$	II-7
202	3.0 m	$\alpha, \text{EC}+\beta^+$	$^{197}\text{Au}(^{12}\text{C}, 7\text{n})$	II-8
203	7.3 m	$\alpha, \text{EC}+\beta^+$	$^{197}\text{Au}(^{12}\text{C}, 6\text{n})$	II-8
204	9.3 m	$\alpha, \text{EC}+\beta^+$	$^{209}\text{Bi}(\alpha, 9\text{n})$	II-9
205	26.2 m	$\alpha, \text{EC}+\beta^+$	$^{209}\text{Bi}(\alpha, 8\text{n})$	II-10
206	31.4 m	$\alpha, \text{EC}+\beta^+$	$^{209}\text{Bi}(\alpha, 7\text{n})$	II-11
207	1.8 h	$\alpha, \text{EC}+\beta^+$	$^{209}\text{Bi}(\alpha, 6\text{n})$	II-9
208	1.6 h	$\alpha, \text{EC}+\beta^+$	$^{209}\text{Bi}(\alpha, 5\text{n})$	II-10
209	5.4 h	$\alpha, \text{EC}+\beta^+$	$^{209}\text{Bi}(\alpha, 4\text{n})$	II-11
210	8.3 h	$\alpha, \text{EC}+\beta^+$	$^{209}\text{Bi}(\alpha, 3\text{n})$	II-12
211	7.2 h	$\alpha, \text{EC}+\beta^+$	$^{209}\text{Bi}(\alpha, 2\text{n})$	II-13
212	0.31 sec	$\alpha$	$^{209}\text{Bi}(\alpha, \text{n})$	II-14
213	0.11 sec	$\alpha$	$^{209}\text{Bi}(^{22}\text{Ne}, 2\text{n})$	II-15
214	2 $\mu\text{sec}$	$\alpha$	descendant $^{226}\text{Pa}$	II-16
215	0.1 msec	$\alpha$	descendant $^{227}\text{Pa}$	II-16

Table II-1 (continued).

Mass	Half life	Decay	Production mode	Reference
216	0.3 msec	$\alpha$	descendant $^{228}\text{Pa}$	II-16
217	32.3 msec	$\alpha, \beta^-$	descendant $^{225}\text{Ac}$	II-17
218	1.5 sec	$\alpha, \beta^-$	daughter $^{226}\text{Ac}$	II-17
219	0.9 msec	$\alpha, \beta^-$	daughter $^{227}\text{Ac}$	II-18



element, the chemical form of elementary astatine has not been determined until now. Astatine is usually present in a volatile state, which has been assumed generally to be  $\text{At}_2$ , when left to its own devices in acidic solution. This state has been referred to "At(0)"[II-19]. Astatine in this state, either as vapor or in dilute nitric acid, has a tendency to be adsorbed by various metallic surface and glass. This form of astatine can be extracted from dilute nitric acid solutions by ethers, carbon tetrachloride or carbon disulfide. It has usually been assumed that the astatine species present in "At(0)" solutions is  $\text{At}_2$ , but Aten, Jr. mentioned that pure astatine didn't seem to be  $\text{At}_2$  in aqueous solutions in view of the very low concentration of the element[II-20].

The determination of the chemical form of elementary astatine has been attempted by Appleman et al.[II-21]. and Golovkov et al.[II-22] through the use of a mass spectrometer to measure the mass directly. In spite of their efforts the existence of  $\text{At}_2$  couldn't be confirmed. One reason of their failure is that the dissociation of  $\text{At}_2$  might be occurred in the plasma ion source. Furthermore, even if  $\text{At}_2^+$  is observed it may be due to the reaction of  $\text{At} + \text{At}^+ \rightarrow \text{At}_2^+$  in the ion source as pointed out by Golovkov et al.[II-22].

There has been no experimental value on the boiling

point of elementary astatine because of the reasons mentioned below:

- (1) The direct measurement of the boiling point is very difficult because astatine has no long-lived isotope and a massive preparation of the sample is difficult.
- (2) Besides, heat is produced by the radioactive disintegration.
- (3) The care for boiling point elevation can not be avoided because astatine produces a considerable amount of polonium by EC-decay.

On the other hand, the boiling points of astatine compounds were estimated indirectly by Samson et al. [II-23] and Meyer et al. [II-24] using a radiogaschromatography (RGC). When the retention volumes of astatine compounds were measured at a constant column temperature, the boiling point was estimated by the extrapolation of the straight line relating the boiling point with the retention volume obtained on the group of homologous compounds (e.g.,  $\text{CH}_3\text{F}$ ,  $\text{CH}_3\text{Cl}$ ,  $\text{CH}_3\text{Br}$ ,  $\text{CH}_3\text{I}$  and  $\text{CH}_3\text{At}$ ). This rule holds at a constant column temperature only, so that this method cannot be applied to groups which have large variation of the retention volume at a given temperature. This method cannot be applied to elementary halogens.

Though the radiogaschromatographic method is indirect it is very suitable for the estimation of the boiling point

of trace radioisotopes. There are no problems on the heat produced by the decay and the boiling point elevation. Further, massive preparation of the sample isn't needed. Also trace samples can be detected with high sensitivity using a radioactive detector. Many studies on the analysis of various radioisotopes have been done by the RGC [II-25, 26].

In the present work  $^{131}\text{I}_2$  containing carrier  $\text{I}_2$  (about ten times the amount of  $^{131}\text{I}_2$ ) was mixed into "At(0)" solution, and then the sample was analyzed by means of a newly designed RGC. It has been well known that AtI was formed when  $\text{I}_2$  was mixed into "At(0)" solution, so three peaks might be observed in the radiochromatogram, viz.,  $\text{I}_2$ , AtI and "At(0)". These peaks were assigned by a sophisticated procedure, and hence the chemical form of elementary astatine was determined. Further, the boiling point of the element was estimated with the semi-empirical theory[II-27] relating the boiling point to the absolute retention volume of an object on gas chromatography.

Since the absolute retention volume is expressed as the function of moles and solubility parameter of the solvent in a column, the boiling point of an object, mean boiling point of sample's family and the column temperature, the boiling point of an object can be estimated from the measured retention volume at a given column temperature. In this

point this method is quite different with Samson's. This method has been widely applied to molecular samples, especially halogens[II-29].

## B. EXPERIMENTAL PROCEDURES

### B-1. Preparation of Astatine

Astatine-209 was produced by the bombardment of 22  $\mu\text{m}$  thick bismuth, which was deposited onto a 15  $\mu\text{m}$  thick aluminum foil by evaporation in vacuo, with 26 MeV  $^3\text{He}$  of the OULNS\* cyclotron. In Fig. II-1 the setting of the target at bombardment is sketched. The target, which was wrapped up in aluminum foil, was cooled by circulating water. This target assembly was held with a special holder at the irradiation port of the cyclotron. The total beam on the target was measured in terms of the integrator. The irradiation time was 3 to 4 hours, which was an appropriate time for the production of  $^{209}\text{At}$ , and the average current was about 2  $\mu\text{A}$ . The yields of astatine isotopes produced were 80  $\mu\text{Ci}$  for  $^{209}\text{At}$  and 7  $\mu\text{Ci}$  for  $^{210}\text{At}$ , which were

---

\* Osaka University, Laboratory of Nuclear Studies

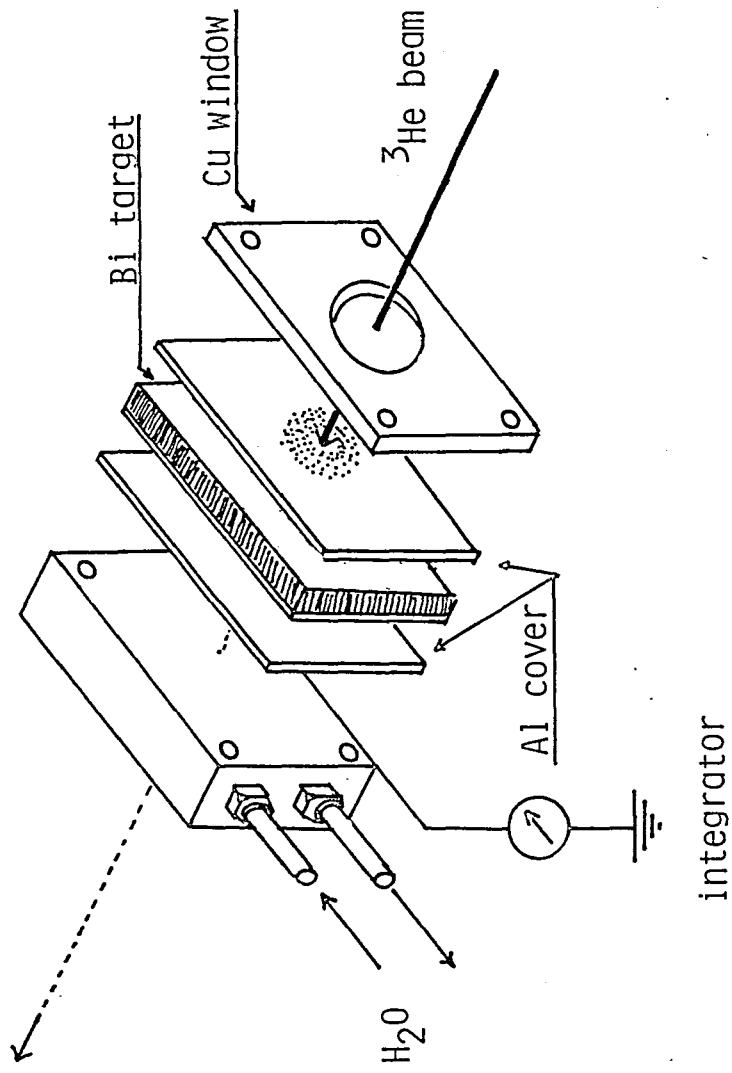

Fig. II-1. Arrangement of the target

calculated on the basis of the excitation function[II-30] shown in Fig. II-2.

After the irradiation the bismuth target was cooled for half an hour, and then it was removed from the target holder. The activities produced in the target was measured by means of a 60 cc Ge(Li) detector. The gamma spectrum which was observed on the target an hour after the end of the bombardment is shown in Fig. II-3. The peaks shown in the gamma spectrum are mostly attributable to  $^{209}\text{At}$  and  $^{210}\text{At}$ . The target was dissolved into 1 N  $\text{HNO}_3$  and then "At(0)" was extracted with carbon disulfide according to the process shown in Fig. II-4. Final activity of  $^{209}\text{At}$  was 50 Ci and the volume of the solution was 100  $\mu\text{l}$ . This solution contained a few  $\mu\text{Cis}$  of  $^{210}\text{At}$ .

## B-2. Radiogaschromatographic Apparatus

In Fig. II-5 the block diagram of the RGC that is newly designed for the purpose of this study is shown. This system is constructed from the Bendix Series 2200 Laboratory Gas Chromatograph, a gas-flow type proportional counter and several electric instruments for the measurement of radioactivity. A four meter stainless steel column with 3 mm inside diameter was packed with 10 %w/w Silicon DC 550

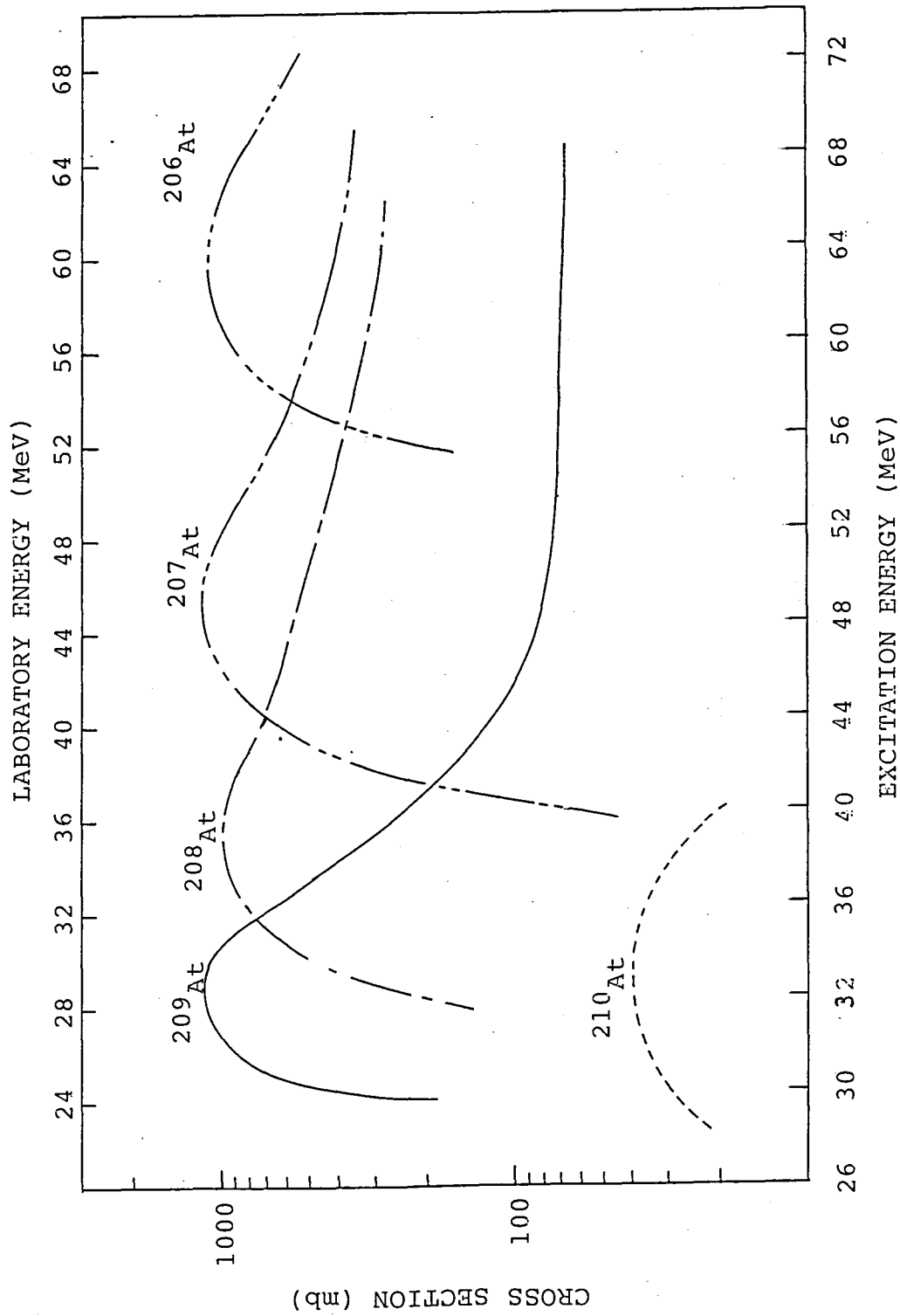

Fig. II-2. Excitation functions for the  $^{209}\text{Bi}(^3\text{He}, \text{xn})^{212-x}\text{At}$  reactions  
 -----  $^{209}\text{Bi}(^3\text{He}, 2\text{n})^{210}\text{At}$ ; ———  $^{209}\text{Bi}(^3\text{He}, 3\text{n})^{209}\text{At}$ .

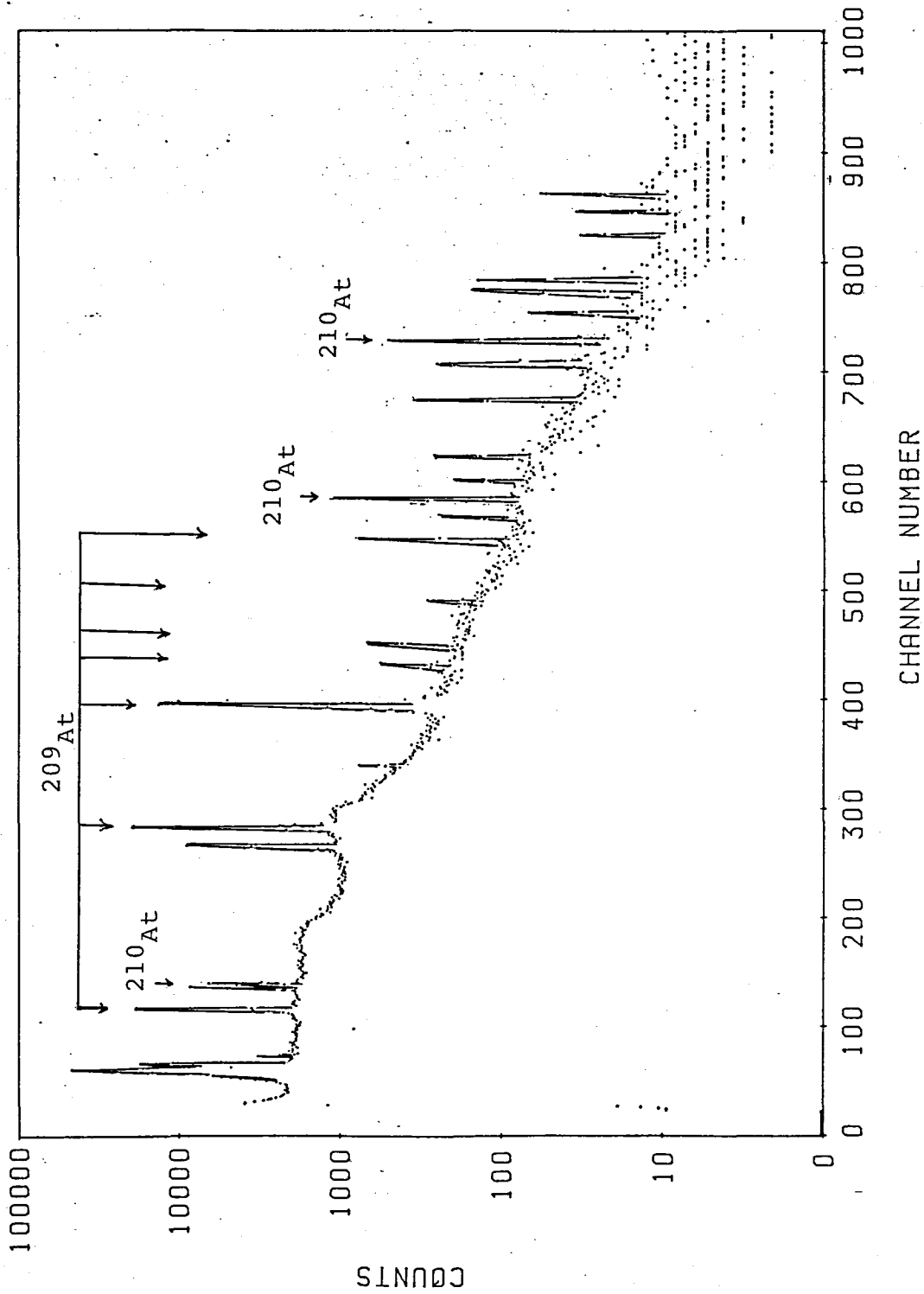

Fig. II-3. Gamma spectrum of bismuth target  
1 ch = 2 keV.



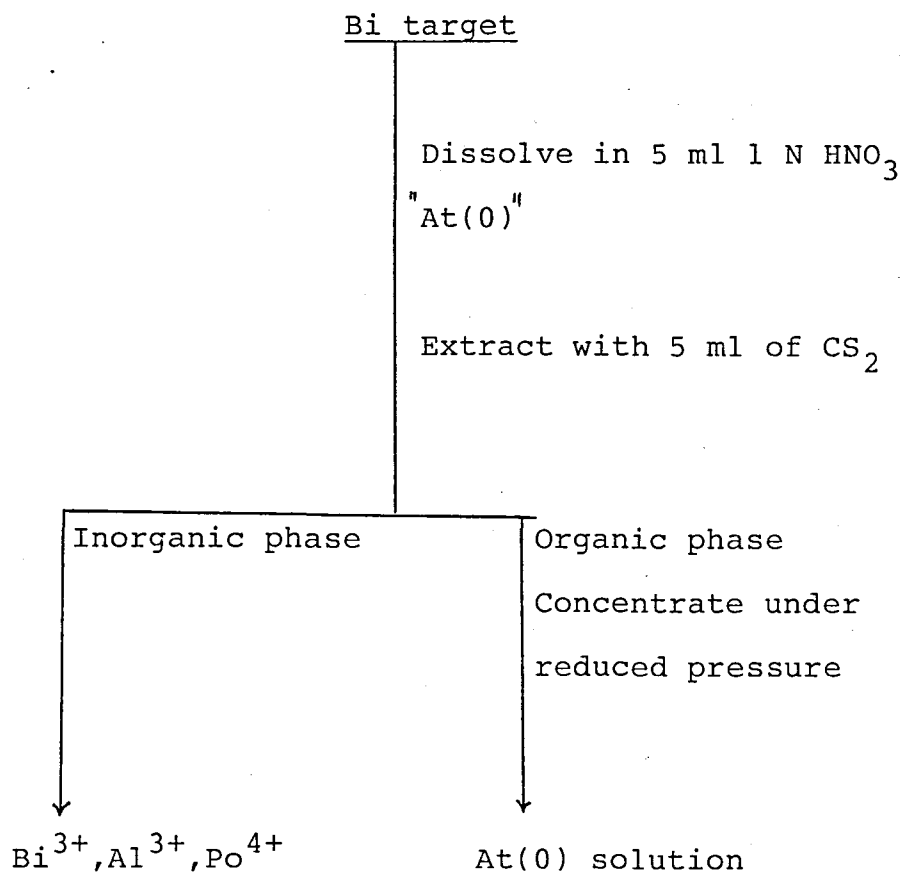

Fig. II-4. Separation of astatine from the bismuth target

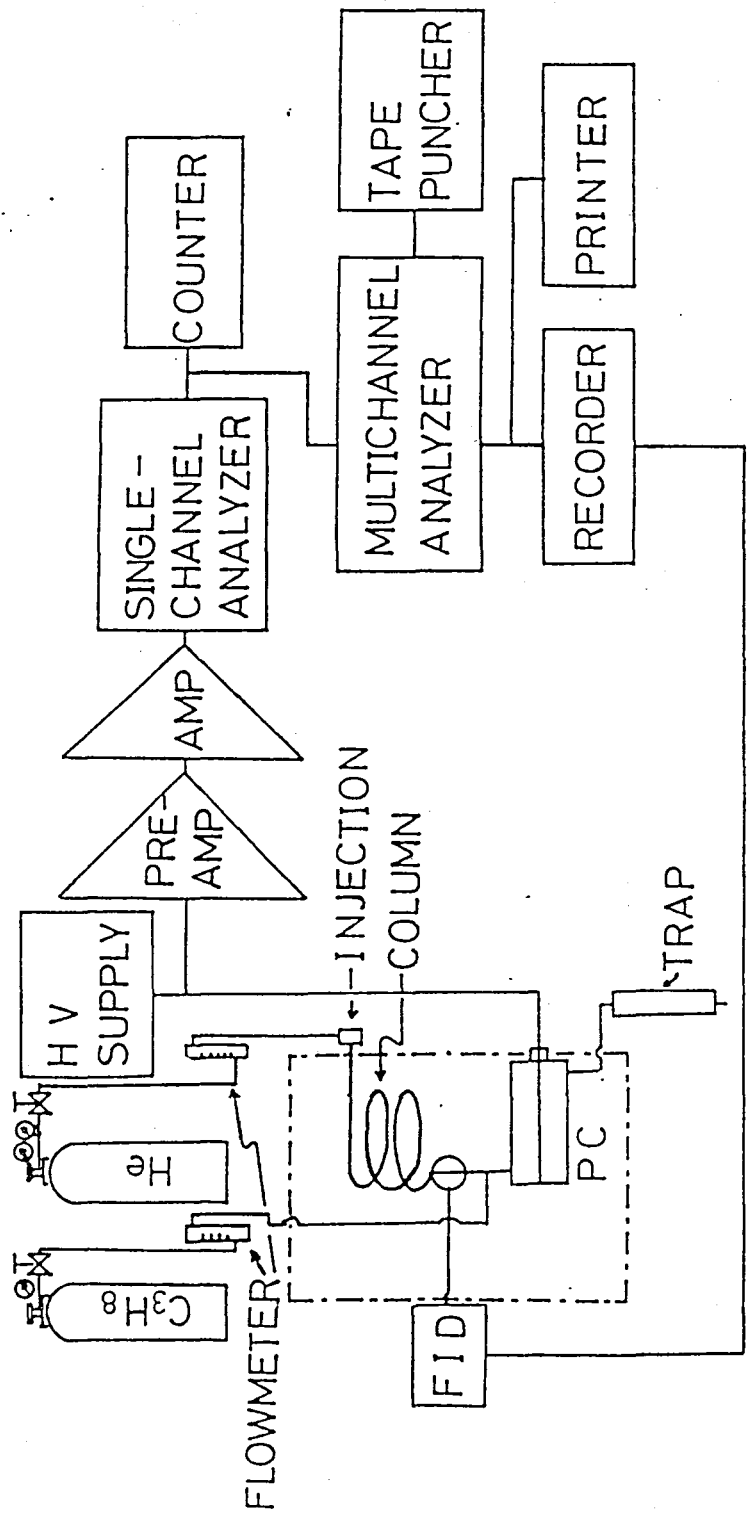

Fig. II-5. BLOCK DIAGRAM OF GAS RADIOCHROMATOGRAPHY

on Chromosorb. The column was installed in the thermostat of the RGC.

Although various detecting systems have been applied to RGC, we used a proportional flow counter from next reasons: It has high counting efficiency because of internal counting system with  $4\pi$  geometry, and it is basically of simple design so that it is readily coupled with a flowing gas system. Further, it can be readily cleaned up if it is contaminated. A rough sketch of the counter is shown in Fig. II-6. The counter is constructed out of a cylindrical stainless wall and a tungsten center wire. The size is 30 mm in inside diameter and 95 mm in length, and the effective volume is about  $20\text{ cm}^3$ . For decontamination the counter can be easily disassembled by withdrawing the center wire assembly.

Helium was used as the carrier gas and helium-propane mixture was used as the counting gas. Propane was mixed immediately before the counter. The flow rate of the gas was adjusted using a soap film burette at the start, and then observed continuously by a flow meter. Based on the gas flow counter a system can be disassembled for quantitative RGC. Then the quantitative analysis depends on the stability of the counter. The change of plateau was measured using  $^{131}\text{I}$  source by varying the propane to helium ratio. The propane to helium ratio was adjusted to 0.07

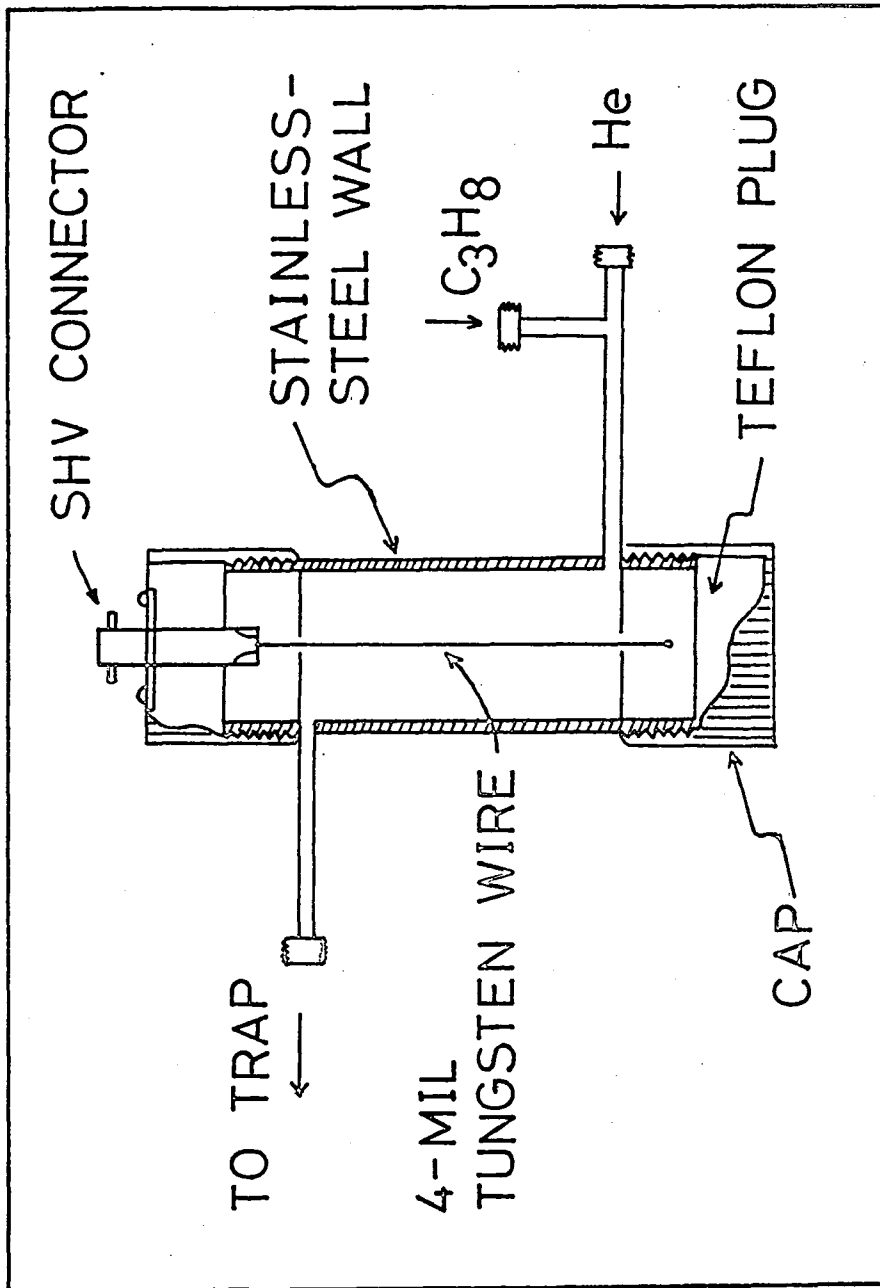

Fig. II-6. Sketch of proportional counter

during the later experiments.

### B-3. Preparation of Samples for Analysis

Three samples were prepared for the measurement as follows:

(1) After the irradiation the bismuth target was dissolved into 5 ml of 1N  $\text{HNO}_3$ , and "At(0)" was extracted with 5 ml of carbon disulfide which had previously been washed with a few mls of 1 N  $\text{HNO}_3$ . The solution was concentrated up to 0.5  $\mu\text{Ci}/\mu\text{l}$  under reduced pressure. This procedure is shown in Fig. II-4.

(2) Carrier-free  $^{131}\text{I}^-$ , which was bought from Amersham International Ltd., was oxidized by the  $\text{H}_2\text{O}_2$ - $\text{H}_2\text{SO}_4$  system, and then  $^{131}\text{I}_2$  was extracted with about 5 ml of carbon disulfide which had been washed with acid. The solution was concentrated to 0.3  $\mu\text{Ci}/\mu\text{l}$  under reduced pressure by the same manner as in the case of astatine.

(3) Carrier- $\text{I}_2$  (about ten times the amount of  $^{131}\text{I}_2$ ) was added to 50  $\mu\text{l}$  of the sample (2), and then 50  $\mu\text{l}$  of the sample (1) was mixed with it.

#### B-4. Analysis of the Samples

Three samples were analyzed by the RGC. If the  $\beta$  ray from  $^{131}\text{I}$  and the  $\alpha$  ray from  $^{209}\text{At}$  can be measured separately, the assignment of the peak in the chromatogram should be very easy. The signals due to  $\alpha$  rays can be selected by discriminating lower pulses since the pulse height is far higher than that of  $\beta$  rays when these radiations are detected by a proportional counter. The signals due to  $\beta$  rays cannot be measured independently since the signals due to electrons scattered by  $\alpha$  rays and EC-Auger electrons mixed. The discriminating level was determined by the use of  $^{210}\text{Po}$ , emitting almost same energy of  $\alpha$  rays as those from  $^{209}\text{At}$ , and  $^{131}\text{I}$  sources.

For determination of the chemical form of elementary astatine about 2  $\mu\text{l}$  aliquots of each sample were analyzed by the RGC. Both  $\alpha$  and  $\beta$  rays were detected with samples (1) and (2), whereas the measurement of  $\alpha$  rays only was carried out with the sample (3) as well as that of  $\alpha$  rays plus  $\beta$  rays. Further, the sample (1) was analyzed by the RGC at several column temperatures for the estimation of the precise boiling point of astatine.

The waste samples were finally trapped on to charcoal. The radioactivity built up in the counter was decontaminated at every ten runs.

## C. RESULTS

### C-1. Plateaus of the Counter

In Fig. II-7 are shown the typical proportional counting plateaus obtained with various propane to helium ratios using an internal  $^{131}\text{I}$  source. All plateaus are virtually flat, and higher propane to helium ratios raise both the threshold and the plateau toward higher voltages.

### C-2. Gas Radiochromatograms

For the determination of the chemical form of elementary astatine three samples were analyzed by means of the RGC at 393 K. The gas radiochromatograms obtained are shown in Fig. II-8. In the figure the abscissa is absolute retention volume which is corrected for free space and pressure gradient, and the ordinate is counts of activity. Chromatograms I and IV are obtained by detecting both  $\alpha$  and  $\beta$  rays on samples (2) and (1), respectively. Chromatograms II and III are obtained by detecting  $\alpha$  rays plus  $\beta$  rays and

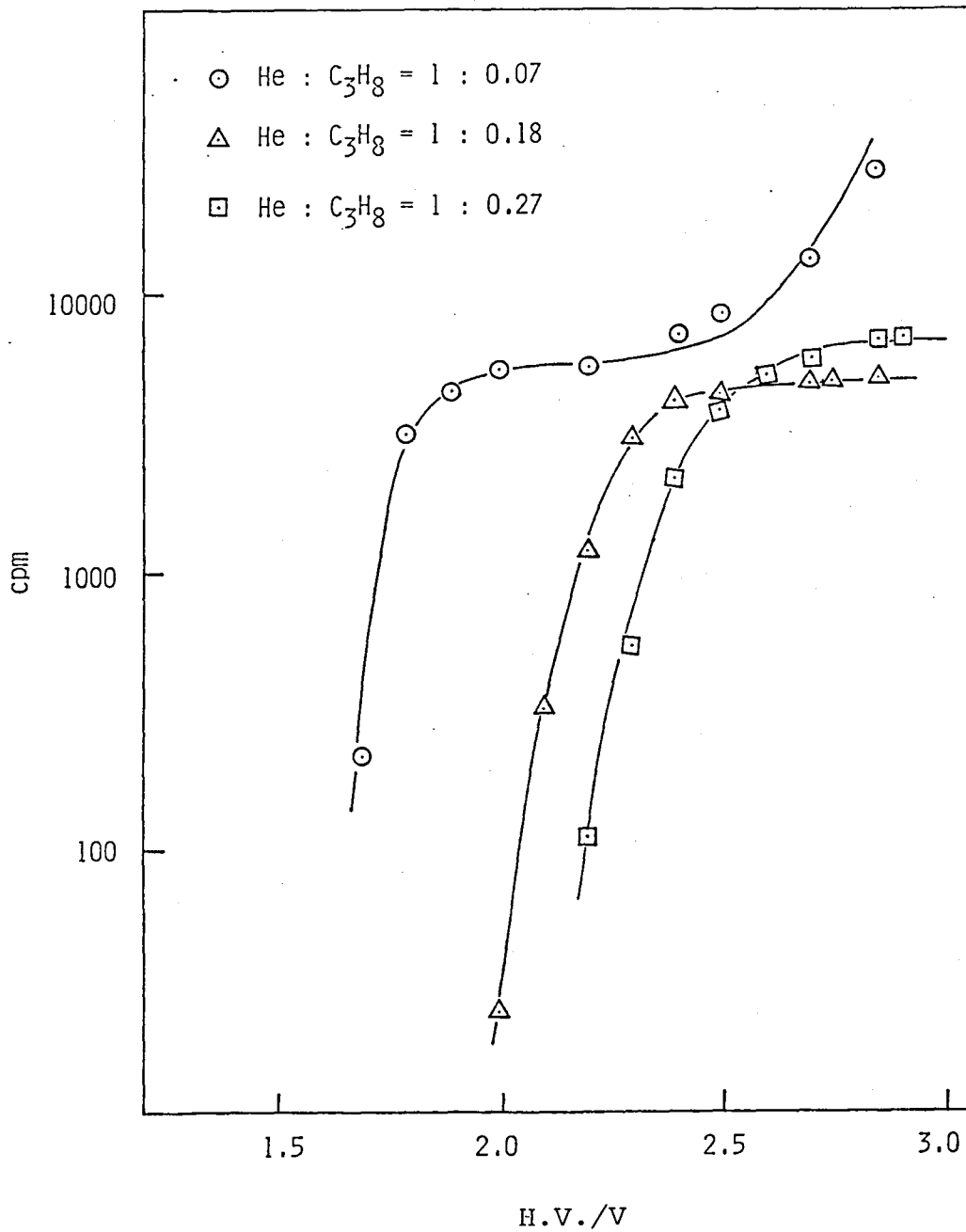
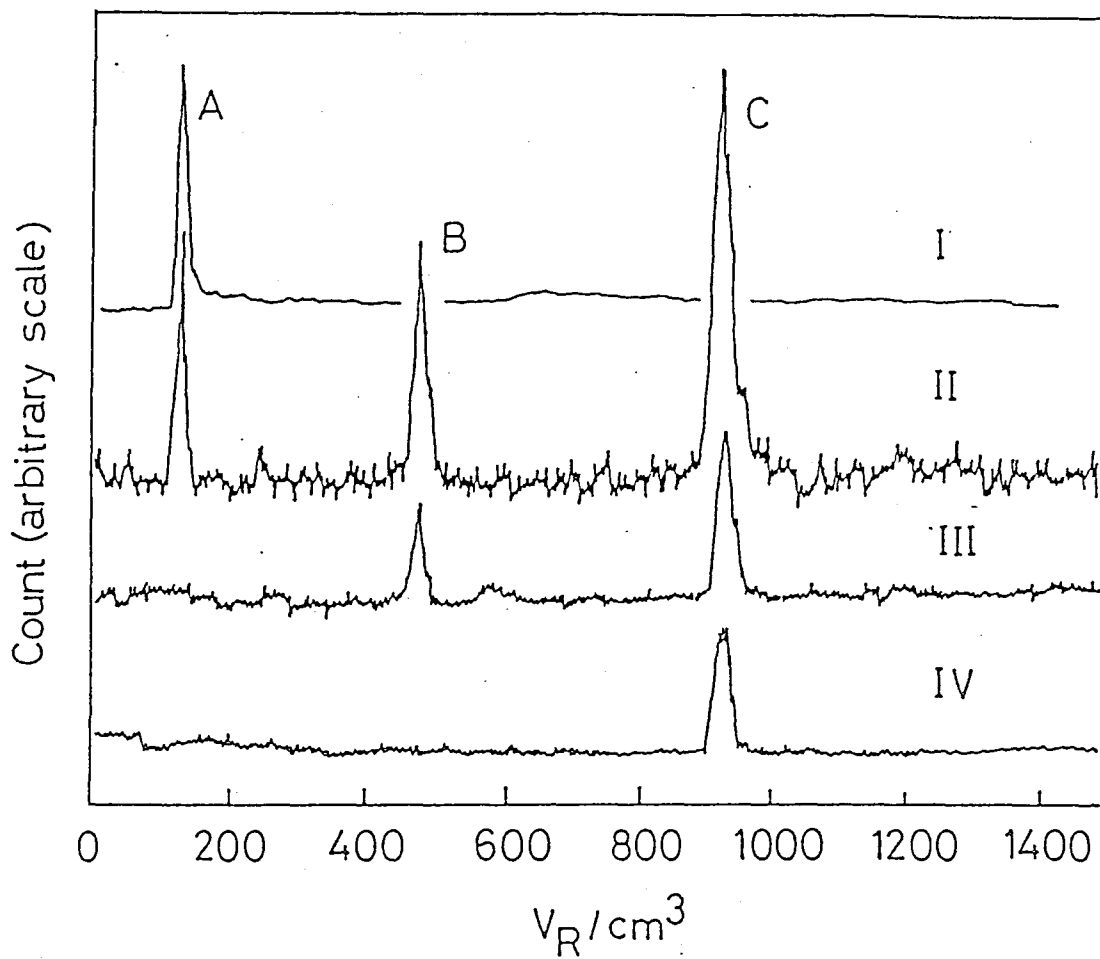

Fig. II-7. Typical proportional counting plateaus obtained with various propane to helium ratios





- I:  $^{131}\text{I}_2$ (carrier-free),  $\alpha$  ray +  $\beta$  ray  
 II:  $^{131}\text{I}_2$ (carrier  $\text{I}_2$ ) + At(0),  $\alpha$  ray +  $\beta$  ray  
 III:  $^{131}\text{I}_2$ (carrier  $\text{I}_2$ ) + At(0),  $\alpha$  ray  
 IV: At(0)(carrier-free),  $\alpha$  ray +  $\beta$  ray

Fig. II-8. Radiochromatograms of samples (1), (2) and (3)

rays only, respectively, on sample (3).

In chromatograms I and IV only a peak is observed, and in chromatograms II and III a few peaks are observed. These peaks shall be assigned later.

Further, the sample (1) was analyzed at several column temperatures by detecting  $\alpha$  rays plus  $\beta$  rays. These chromatograms are shown in Fig. II-9.

Peak positions were graphically obtained and were computed by the smoothing and differentiation of the data.

### C-3. Estimation of the Boiling Point by Semi-Empirical Theory

For molecular solutes the retention volume,  $V_R$ , on gas chromatography is simply expressed as

$$V_R = f(N, \delta_s, T_b, \bar{T}_b, T). \quad (\text{II-1})$$

Here,  $V_R$  ( $\text{cm}^3$ ) is the absolute retention volume corrected for free space and pressure gradient,  $N$  (mole) the moles of the solvent in a column,  $\delta_s$  ( $\text{cal}^{1/2}\text{cm}^{-3/2}$ ) the solubility parameter of the solvent,  $T_b$  (K) the boiling point of the solute,  $\bar{T}_b$  (K) the mean boiling point of the family and  $T$  (K) the column temperature. Details will be mentioned in

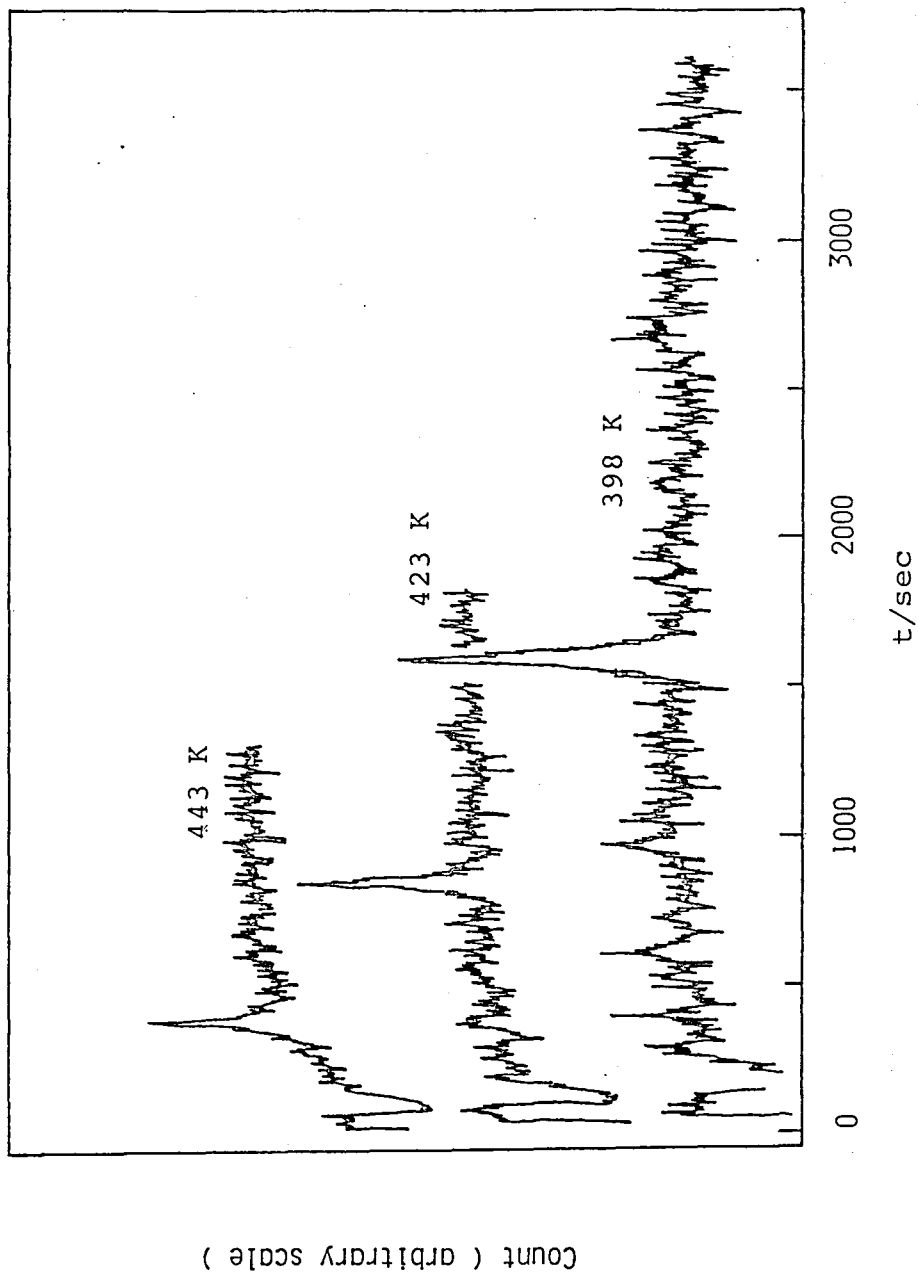

Fig. II-9. Radiochromatograms of  $At_2$  at several column temperatures

Appendix (i).

Now, if  $N$  and  $\delta_s$  which are characteristic of the solvent are known,  $V_R$  is expressed as the function of  $T_b$  only for a given  $T$ . Therefore,  $T_b$  can be estimated by measuring  $V_R$  at a given column temperature. This method has been well tested on halogens[II-30].

The molecular weight,  $M_w$ , and  $\delta_s$  of the solvent used in this experiment were determined previously and  $N$  is calculated from the molecular weight. The quantities of  $M_w$  and  $\delta_s$  are tabulated in Table II-2.

The estimated boiling points for the peaks in Figs. II-8 and II-9 are listed in Table II-3 and II-4, respectively.

The error of the boiling point estimated is mainly derived from the deviation of the retention volume measured by the RGC.

#### D. DISCUSSION

##### D-1. Assignments of peaks (Determination of the Chemical Form of Elementary Astatine)

The peaks of A, B and C in Fig. II-8 are assigned to

Table II-2. Molecular weight  $M_w$  and solubility parameter  $\delta_s$ , of the solvents used

Solvent	$M_w$	$\delta_s$
Silicon DC 550	50000	8.1
702	62300	8.0
710	89200	7.9
PEG 1500	1500	11.7
4000	3100	11.6
6000	6750	11.6

Table II-3. Boiling points of peaks A, B and C

Peak	Retention volume (cm <sup>3</sup> )	Boiling point (K)
A	120 ± 2	457 ± 2
B	485 ± 2	486 ± 2
C	929 ± 2	504 ± 3

Table II-4. Boiling points of At<sub>2</sub> at several temperatures

Column temp. (K)	Retention volume (cm <sup>3</sup> )	Boiling point (K)	
		calc.	extrap.
393	929 ± 2	504 ± 2	
398	850 ± 2	503 ± 3	
423	339 ± 2	502 ± 3	
443	182 ± 2	502 ± 3	
mean		503 ± 3	585 <sup>a</sup>

a; given in Ref. II-29.

$I_2$ , AtI and  $At_2$ , respectively, from the following reasons:

(1) Peak A is attributable to  $I_2$  since only this peak is observed in the chromatogram I and there at least exist  $^{131}I_2$  molecules. This is consistent with the fact that the boiling point of this peak agrees well with that of  $I_2$ , 457.5 K, as shown in Table II-3.

(2) Peak C may be attributable to "At(0)" since only this peak is observed in the chromatogram IV and there at least exist At(0) molecules. If it is due to a compound of astatine with organic impurities, one or more additional peaks should be observed in the chromatogram. The peak C was as well observed when other solvents (e.g., benzene and carbon tetrachloride) were used as with  $CS_2$ . Therefore, the possibility of the formation of astatine organic compounds is ruled out though "At(0)" is known to react with organic substances.

(3) Peak B must be attributed to the compound of astatine with iodine since it can be first observed when "At(0)" is mixed with  $I_2$  and  $\alpha$  rays are detected at the peak as shown in the chromatogram III. Furthermore, it is well known that AtI is produced by the reaction of "At(0)" with  $I_2$ , so the peak may be AtI.

(4) We have found a remarkable relationship holding among halogen molecules and diatomic interhalogen compounds. Namely, the boiling point of a diatomic interhalogen



compound is nearly equal to the mean boiling point of constituent elements as shown in Table II-5. The chemical forms of peaks B and C are AtI and At<sub>2</sub>, respectively, as for the other halogens; this rule holds on the boiling point of peaks A, B and C. If the peak C is due to a compound of astatine with impurities, this rule may hardly hold.

#### D-2. Formation of AtI and the Anomalous

##### Boiling point of At<sub>2</sub>

Now, AtI would be produced by the hot atom reaction as

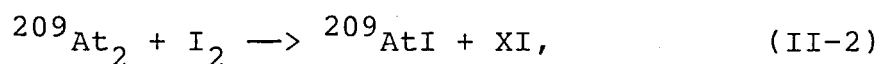

in which X is the daughter of astatine in solution, or by the ordinary chemical reaction in the vaporization cell where temperature is higher than the room temperature. The study on the hot atom reaction of At<sub>2</sub> will be discussed in Appendix (ii).

Estimation of the boiling points of At<sub>2</sub> at several column temperatures are mutually compatible, but the value is much lower (by 82 K) than that extrapolated from the other halogens. Although the anomaly of the boiling point will be discussed later together with that of radon, it can

Table II-5. Boiling points of interhalogen compounds

	$F_2$	ClF	$Cl_2$	BrCl	$Br_2$	IBr	$I_2$	AtI	$At_2$
observed (K)	85	173	236	278	332	389	457	486	503
mean (K)		160		284		395		480	

mentioned here that the anomalous boiling point of  $\text{At}_2$  should not be due to the anomalous behavior of carrier-free species, since no anomaly could not be observed on carrier-free  $^{131}\text{I}_2$ .

### III. ESTIMATION OF THE BOILING POINT BY RADIOGASCHROMATOGRAPHY

#### A. INTRODUCTORY CONSIDERATIONS

Radon has been well known as the decay product of  $^{226}\text{Ra}$  (i.e., emanation). This element has no stable isotopes like astatine. We know about thirty isotopes for the element now as shown in Table III-1. In these isotopes  $^{222}\text{Rn}$  has the longest half life which is 3.8 day. Radon has been widely used as the so-called emanation method[III-12] which yields information about the characters of solid materials. As well known this element belongs to the group VIII in the periodic table, and it has been seemed to be chemically inactive similarly to the other rare gases. The studies on radon compounds have been done since Batlett et al. synthesized xenon complexes at 1962[III-13].

Although there are a few studies on the chemical properties of radon, the boiling point of the element being the most fundamental property was measured only by

Table III-1. Isotopes of radon

Mass	Half life	Decay	Production mode	Reference
200	1.0 sec	$\alpha$	Th(p, spall)	III-1
201	3.8 sec	$\alpha$	$^{197}\text{Au}(^{14}\text{N}, 10\text{n})$	III-2
202	< 1 sec	$\alpha$	$^{197}\text{Au}(^{14}\text{N}, 9\text{n})$	III-2
203	45 sec	$\alpha, \text{EC}+\beta^+$	$^{197}\text{Au}(^{14}\text{N}, 8\text{n})$	III-2
204	75 sec	$\alpha, \text{EC}+\beta^+$	$^{197}\text{Au}(^{14}\text{N}, 7\text{n})$	III-2
205	170 sec	$\alpha, \text{EC}+\beta^+$	$^{197}\text{Au}(^{14}\text{N}, 6\text{n})$	III-2
206	5.6 m	$\alpha, \text{EC}+\beta^+$	$^{197}\text{Au}(^{14}\text{N}, 5\text{n})$	III-2
207	9.2 m	$\alpha, \text{EC}+\beta^+$	$^{197}\text{Au}(^{14}\text{N}, 4\text{n})$	III-3
208	24.3 m	$\alpha, \text{EC}+\beta^+$	$^{197}\text{Au}(^{14}\text{N}, 3\text{n})$	III-3
209	28.5 m	$\alpha, \text{EC}+\beta^+$	daughter $^{213}\text{Ra}$	III-4
210	2.4 h	$\alpha, \text{EC}+\beta^+$	$^{232}\text{Th}(\text{p}, \text{spall})$	III-4
211	14.6 h	$\alpha, \text{EC}+\beta^+$	$^{232}\text{Th}(\text{p}, \text{spall})$	III-5
212	23 m	$\alpha$	daughter $^{212}\text{Fr}$	III-6
213	25 m	$\alpha$	daughter $^{217}\text{Ra}$	III-6
214	0.27 $\mu\text{sec}$	$\alpha$	descendant $^{222}\text{Th}$	III-7
215	2.3 $\mu\text{sec}$	$\alpha$	$^{232}\text{Th}(\alpha, 9\text{n})$	III-8
216	45 $\mu\text{sec}$	$\alpha$	descendant $^{228}\text{U}$	III-9
217	0.5 msec	$\alpha$	descendant $^{229}\text{U}$	III-9
218	35 msec	$\alpha$	descendant $^{230}\text{U}$	III-9
219	3.9 sec	$\alpha$	descendant $^{227}\text{Th}$	III-9
220	55 sec	$\alpha$	descendant $^{228}\text{Th}$	III-9
221	24 m	$\alpha + \beta^-$	Th(p, spall)	III-4

Table III-1 (continued)

Mass	Half life	decay	Production mode	Reference
222	3.8 d	$\alpha$	natural source	III-9
223	43 m	$\beta^-$	$^{232}\text{Th}(p, \text{spall})$	III-10
224	1.78 h	$\beta^-$	$^{232}\text{Th}(p, \text{spall})$	III-10
225	4.5 m	$\beta^-$	$^{232}\text{Th}(p, \text{spall})$	III-11
226	6 m	$\beta^-$	$^{232}\text{Th}(p, \text{spall})$	III-11

Rutherford[III-14] and Gray and Ramsay[III-15] at 1909, and there has been few experiments on the boiling point thereafter it except for the measurement by Wertenstein[III-16]. The boiling point was estimated by the measurement of the variation of the vapor pressure with changing temperature on  $^{222}\text{Rn}$ . But the decay scheme of  $^{222}\text{Rn}$  was uncertain at that time, and so the contribution of helium to the vapor pressure of Rn was unable to be estimated. The exact measurement of the pressure of He might not be done because of the trace amount of He. Therefore, these values may include fairly large errors. In an analogous experiment Wertenstein obtained a value higher by 15 K than that measured by Gray and Rasay. As mentioned in the study of astatine, the estimation of the boiling point with the RGC method is superior to the measurement of the vapor pressure, but the shortage of the RGC is that it is indirect. In this method the impurities (decay products) in the sample are separated in a column and so their effects are removed in principle. Further, the sample used is of a trace amount so that the heat involved in the decay needs not to be considered. Since this method is indirect, the applicability must be confirmed for a similar substance, the boiling point of which is known.

Generally the column is set at a lower temperature than the boiling point of the sample when the retention volume is

measured by means of a gas chromatography. Since the boiling point of elementary astatine was fairly high, the retention volumes were measured at the range of 390 K to 440 K. No particular attentions for the solvent in the columns had to be paid. On the contrary, if the retention volume of radon is to be measured by the RGC, it should be measured at a lower temperature than 200 K. In this case the temperature is very low, so that the solvent used in the column may solidify. If the solvent solidifies, the semi-empirical relation between the retention volume and the boiling point doesn't hold. Therefore, the solvent which doesn't solidify at such low temperature must be used in the experiment. As there are no solvents, which don't solidify at such temperatures, the retention volume must be measured at a higher column temperature than the boiling point of the object. On the other hand, a large retention volume is desirable for precise estimation of the boiling point. Now we must seek a solvent which realize the operation of the RGC at a temperature as low as possible, so close to the boiling point of Rn that a large retention volume is obtained.

In the present work the boiling point of Rn was estimated with this method and xenon was used as a checking substance.



## B. EXPERIMENTAL

### B-1. Preparation of Radon and Xenon Samples

The samples of  $^{222}\text{Rn}$ , which was the decay product from  $^{226}\text{Ra}$ , and  $^{133}\text{Xe}$ , which was bought from Amersham International, Ltd., were prepared in a vacuum line shown in Fig. III-1. For the preparation of the Rn sample about 2  $\mu\text{Ci}$  of  $^{226}\text{Ra}$  was placed in a sample vessel and then the vessel was evacuated. This sample was allowed to stand for three weeks, and the growth of  $^{222}\text{Rn}$  was waited. The vessels, which contained Rn and Xe, were attached to the vacuum line as shown in Fig. III-1.

Prior to the introduction of the gases the line was evacuated and dried. Next, the sample vessels were opened, and once the gases were stored in cold trap which was cooled with liquid nitrogen. A finite aliquot of the gas sample was led to the RGC through a stainless steel pipe which was connected to the right side of the glass line.

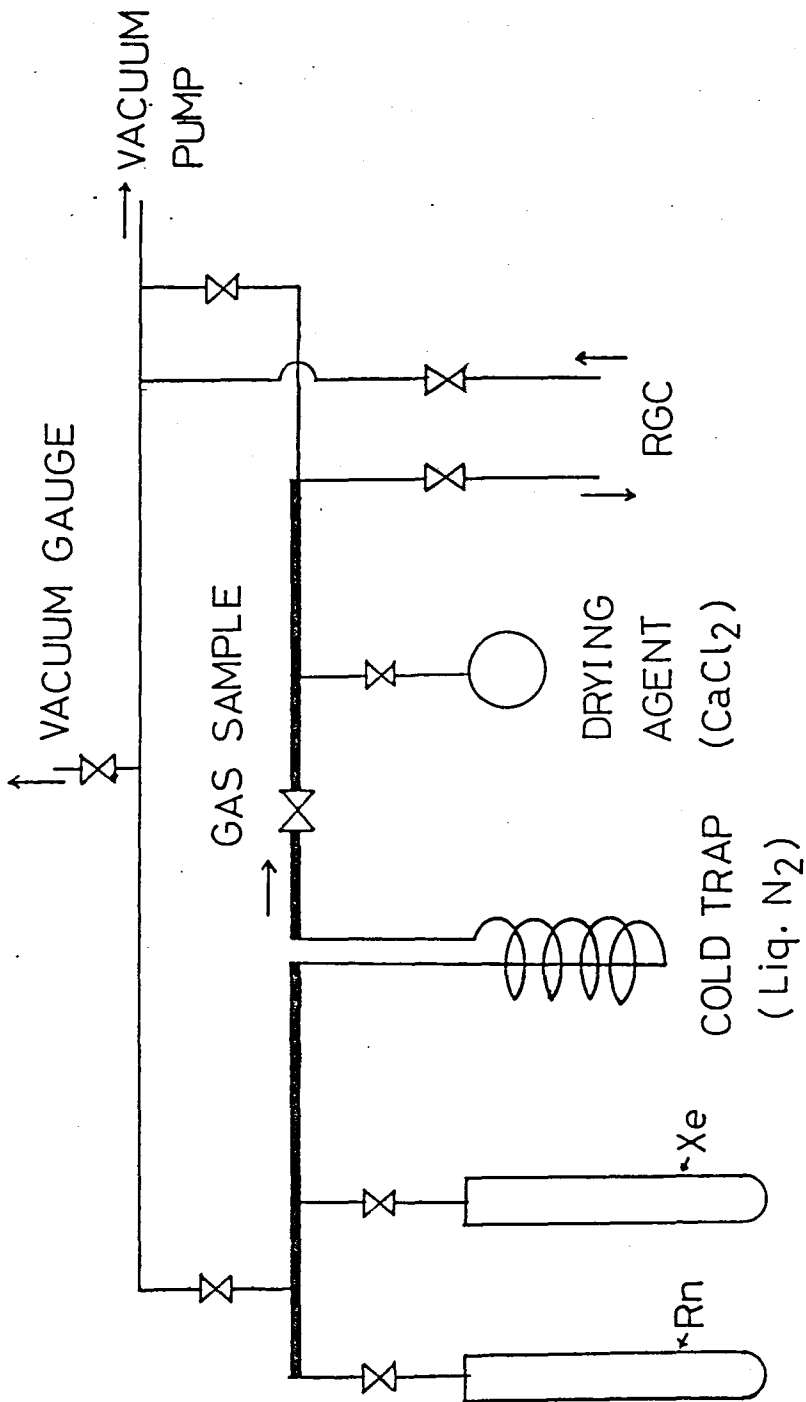

Fig. III-1. Vacuum line for the preparation of gas sample

## B-2. Modified RGC System

For the estimation of the boiling point of radon we had to measure the retention volume at the temperature as near to the boiling point of Rn as possible and to use the solvent, which didn't solidify at such low temperature. We reached squalene as a possible candidate of the solvent among several materials surveyed and proved its usefulness. As the RGC used for the experiments on astatine couldn't be operated under the room temperature (about 300 K), the equipment was modified. The block diagram of this system is shown in Fig. III-2. The thermostat in the RGC was cooled by blowing liquid nitrogen via a solenoid valve and was kept at a designed temperature. The solenoid valve and the heater were controlled by the temperature controller. It was possible to operate at a very low temperature (it was possible to operate at 77 K in principle).

In the present work a 8 port rotary valve, which enabled to introduce gas samples on-line, was equipped in the RGC. The schematic diagram of the valve is shown in Fig. III-3. Gas samples are led to "SAMPLE IN" and emerged from "SAMPLE OUT" through "LOOP A". Then, desired aliquots of the sample can be trapped at "LOOP A" by cooling it with liquid nitrogen, while helium as carrier-gas is now led to

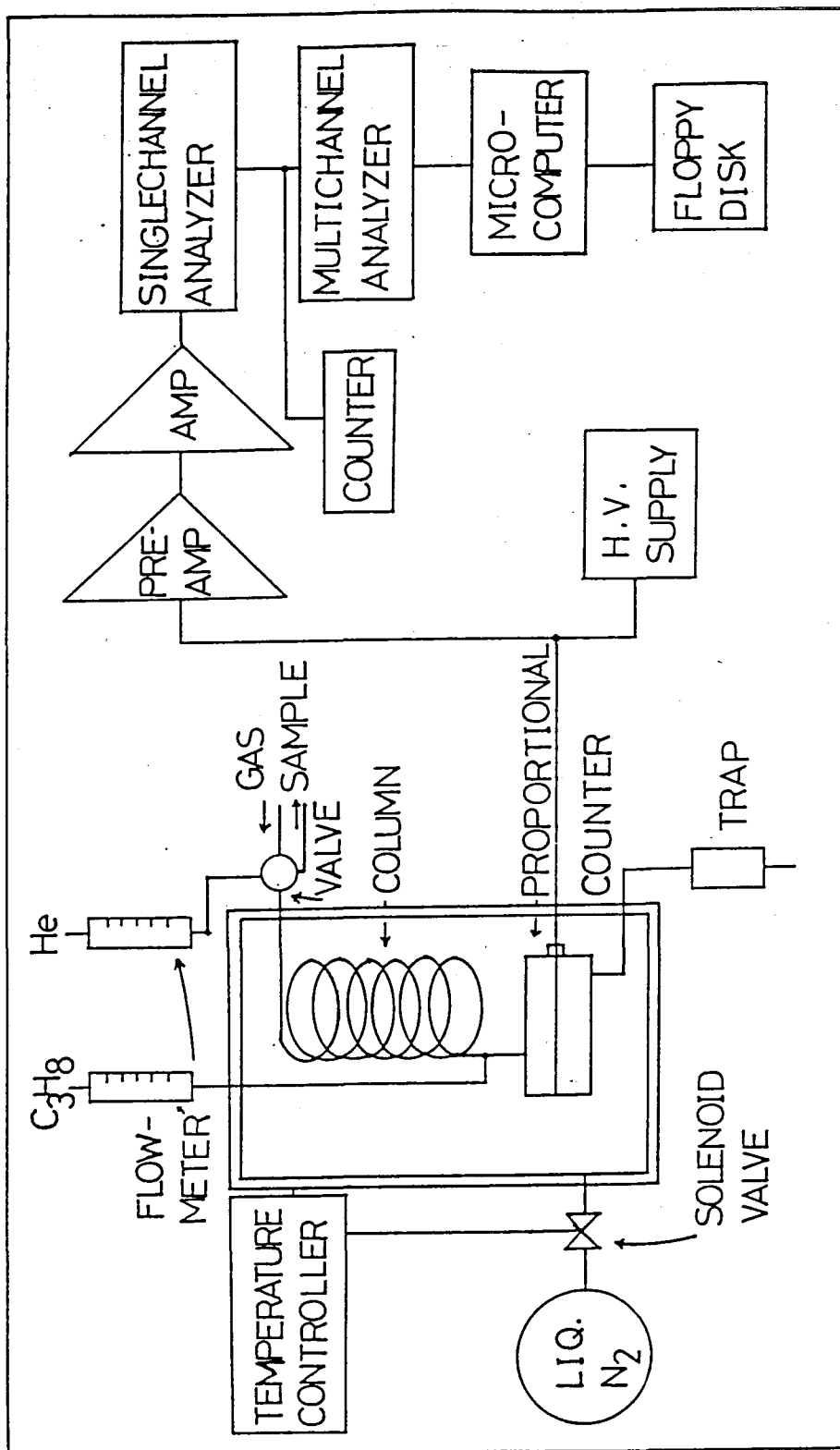

Fig. III-2. Block diagram of modified RGC

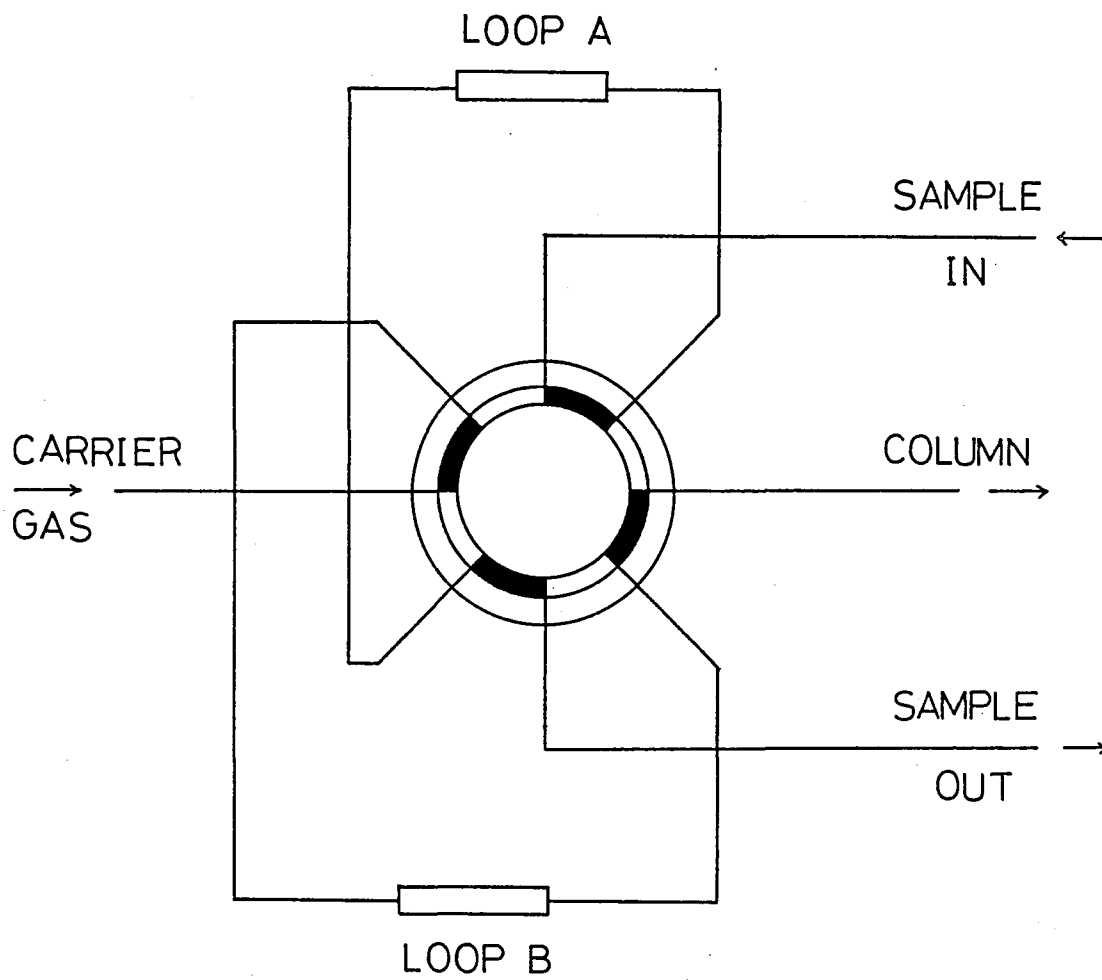

Fig. III-3. Rotary valve for the injection of gas sample

the column through "LOOP B". When the valve is turned by 45°, the gas sample stored "LOOP A" is expelled by the carrier-gas and is injected into the column.

A proportional counter was used as a detector. This counter had been used previously on the experiment of astatine. Alpha and beta rays were detected together for  $^{222}\text{Rn}$  and  $^{133}\text{Xe}$ , respectively, and these signals were stored in a multichannel analyzer in the multiscaling mode. The acquired data were recorded on floppy disks through a microcomputer, and were analyzed by the computer.

### B-3. Analysis of Rn and Xe by RGC

Radon and xenon samples prepared in the vacuum line shown in Fig. III-1 were analyzed on-line by the RGC. The retention volumes of radon were measured at several column temperatures using squalene, and further at 323 K using PEG 1500. For xenon the retention volumes were measured at several column temperatures using squalene. The radioactivities of  $^{222}\text{Rn}$  and  $^{133}\text{Xe}$  were about 0.2  $\mu\text{Ci}$  and 0.3  $\mu\text{Ci}$ , respectively.

## C. RESULTS

### C-1. Estimated Boiling Points of Rn and Xe

The typical radiogaschromatograms of Rn and Xe are shown in Figs. III-4 and III-5, respectively. The radiogaschromatogram shown in Fig. III-4 was obtained on  $^{222}\text{Rn}$  using squalene at 273 K, and Fig. III-5 was obtained on  $^{133}\text{Xe}$  using squalene at 229 K. In the figures the ordinate is counts of radioactivities and the abscissa is the retention time. In Figs. III-4 and III-5 only one peak is observed, and so these peaks can be attributed to Rn and Xe, respectively. These peaks shift to a smaller retention time with increasing column temperature.

Then, we calculated the boiling points of Rn and Xe from the absolute retention volumes measured by the semi-empirical formula (II-1). We recall that the formula is expressed as follows:

$$V_R = f(N, \delta_s, T_b, \bar{T}_b, T).$$

The molecular weight ( $M_w$ ) and the solubility parameter ( $\delta_s$ ) were already determined for PEG 1500, and the moles could be

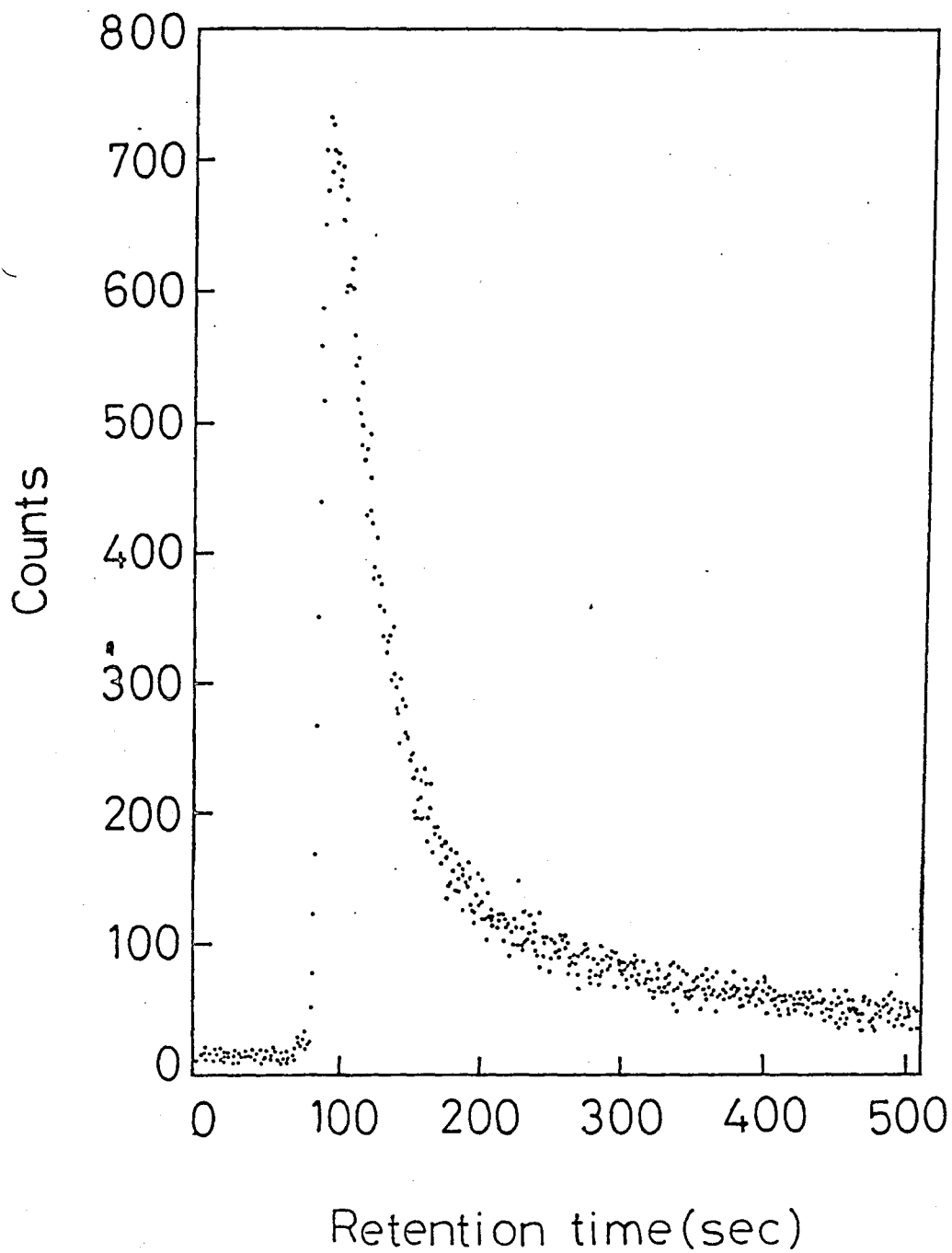

Fig. III-4. Radiochromatogram of Rn at 273 K



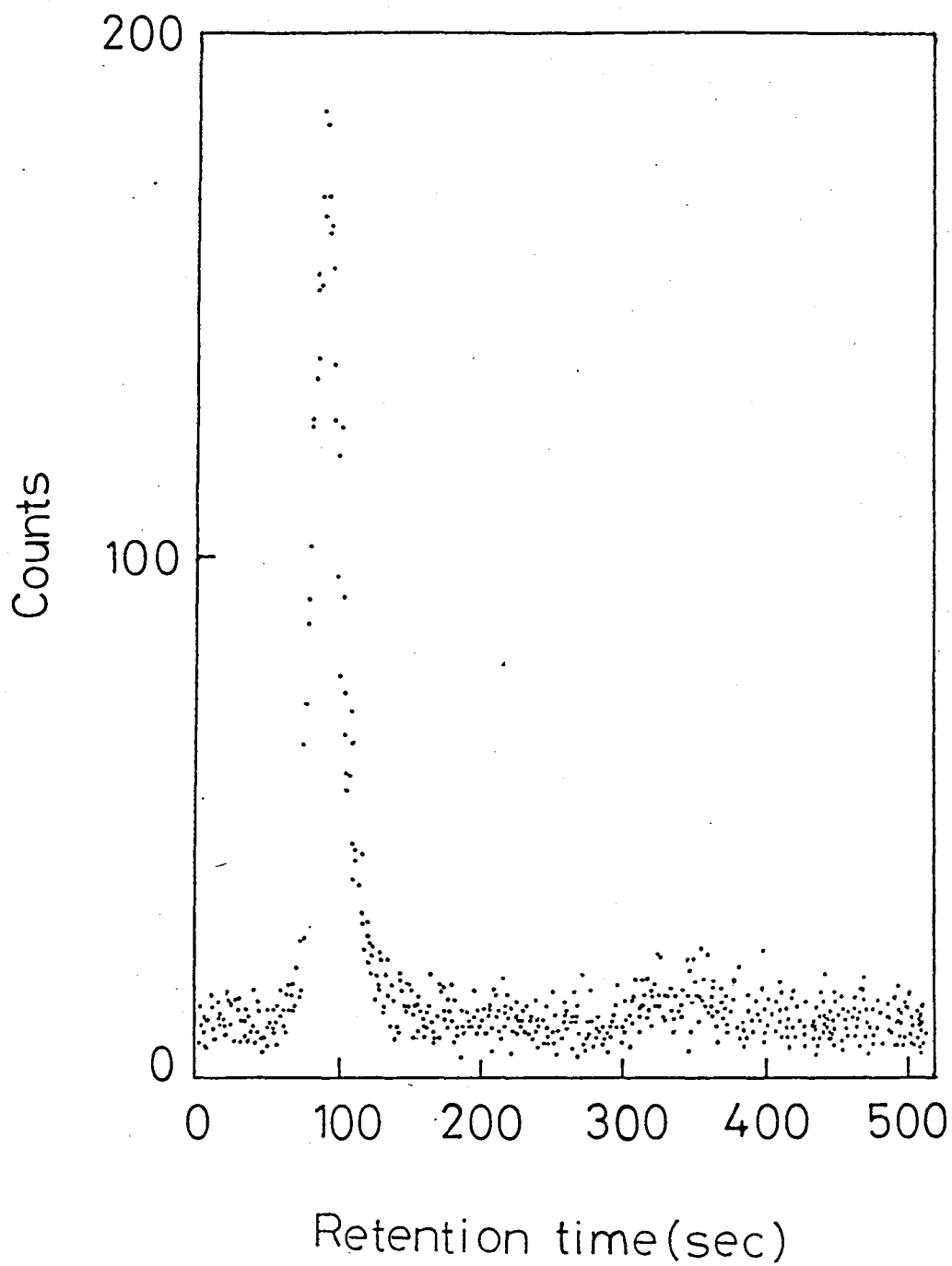

Fig. III-5. Radiochromatogram of Xe at 229 K

calculated from  $M_w$ . Although  $M_w$  of squalene was known, was not determined. The solubility parameter of squalene  $\delta_s$  was measured using  $I_2$  by a conventional method, which is described closely in Appendix (iii).

The properties of these solvents are tabulated in Table III-2. The resulting boiling points of Rn and Xe are listed in Tables III-3 and III-4, respectively, with the literature values.

#### D. DISCUSSION

##### D-1. Applicability of the Semi-Empirical Theory on Rare Gases

Although the semi-empirical theory has been well tested on halogens, it was not tested on rare gases. So there is no guarantee for that the theory holds on rare gas at low temperature. We must confirm that the theory holds on rare gas too. Thus the theory was tested on Xe. The boiling point of Xe was estimated from the retention volume measured by the formula (II-1) and was compared with literature value. The results are given in Table III-3. As shown in the table estimated boiling points at several column temperatures

Table III-2. Properties of the solvents used

Solvent	$M_w$	$\delta_s$
Squalene	410	9.7
PEG 1500	1500	11.7

Table III-3. Boiling point of Rn measured at various column temperatures.

Column temp. (K)	Retention volume (cm <sup>3</sup> )	Boiling point (K)	
		obs.	liter.
296 <sup>a)</sup>	6.9 ± 0.2	198 ± 1	211 <sup>c)</sup> , 208 <sup>d)</sup>
273 <sup>a)</sup>	12.2 ± 0.1	201 ± 1	
251 <sup>a)</sup>	17.8 ± 0.1	198 ± 1	
229 <sup>a)</sup>	27.5 ± 0.5	195 ± 1	
323 <sup>b)</sup>	9.2 ± 0.4	197 ± 3	
mean		198 ± 2	

a) Squalene ( $N = 1.380 \times 10^{-4}$  mol,  $\delta_s = 9.7 \text{ cal}^{1/2} \text{ cm}^{-3/2}$ ) was used as solvent in the column.

b) PEG 1500 ( $N = 1.513 \times 10^{-3}$  mol,  $\delta_s = 11.7 \text{ cal}^{1/2} \text{ cm}^{-3/2}$ ) was used as solvent in the column.

c) Obtained by Rutherford.

d) Obtained by Gray and Ramsay.

Table III-4. Boiling point of Xe

Column temp. (K)	Retention volume (cm <sup>3</sup> )	Boiling point (K)	
		obs.	liter.
273 <sup>a)</sup>	3.3 ± 0.2	164 ± 2	166.0 <sup>b)</sup>
254 <sup>a)</sup>	5.4 ± 0.2	170 ± 1	
229 <sup>a)</sup>	9.3 ± 0.2	170 ± 1	
mean		168 ± 3	

a) Squalene ( $N = 1.380 \times 10^{-4}$  mol,  $\delta_S = 8.7 \text{ cal}^{1/2} \text{ cm}^{-3/2}$ )  
was used as solvent in the column.

agreed well one another, and with the literature value too. This implies that the semi-empirical theory excellently holds on rare gases at a low temperature.

#### D-2. Choice of the Solvent in RGC and Error of the Boiling Point Estimated

In the present work the retention volumes of rare gases had to be measured at higher temperatures than the boiling points of the samples, since there were no solvents, which didn't solidify below such temperatures. Generally the retention volume observed is very small at such a temperature. On the semi-empirical theory the retention volume is expressed as the function of  $N$ ,  $\delta_s$ ,  $T_b$ ,  $\bar{T}_b$  and  $T$  as mentioned previously. The boiling point is given when the object is given, and the range of  $T$  is also limited by the solvent used. So the retention volume actually depends on  $\delta_s$ . We must successfully choose the solvent in order to obtain a large retention volume. Squalene is the best solvent for rare gases from the standpoint of solidification and the retention volume. The measurement of the retention volume of Rn is, however, possible by using PEG 1500 too.

The relations between  $V_R$ ,  $T_b$  and  $T$  are shown in Figs. III-6 and III-7. Fig. III-6 shows the variation of

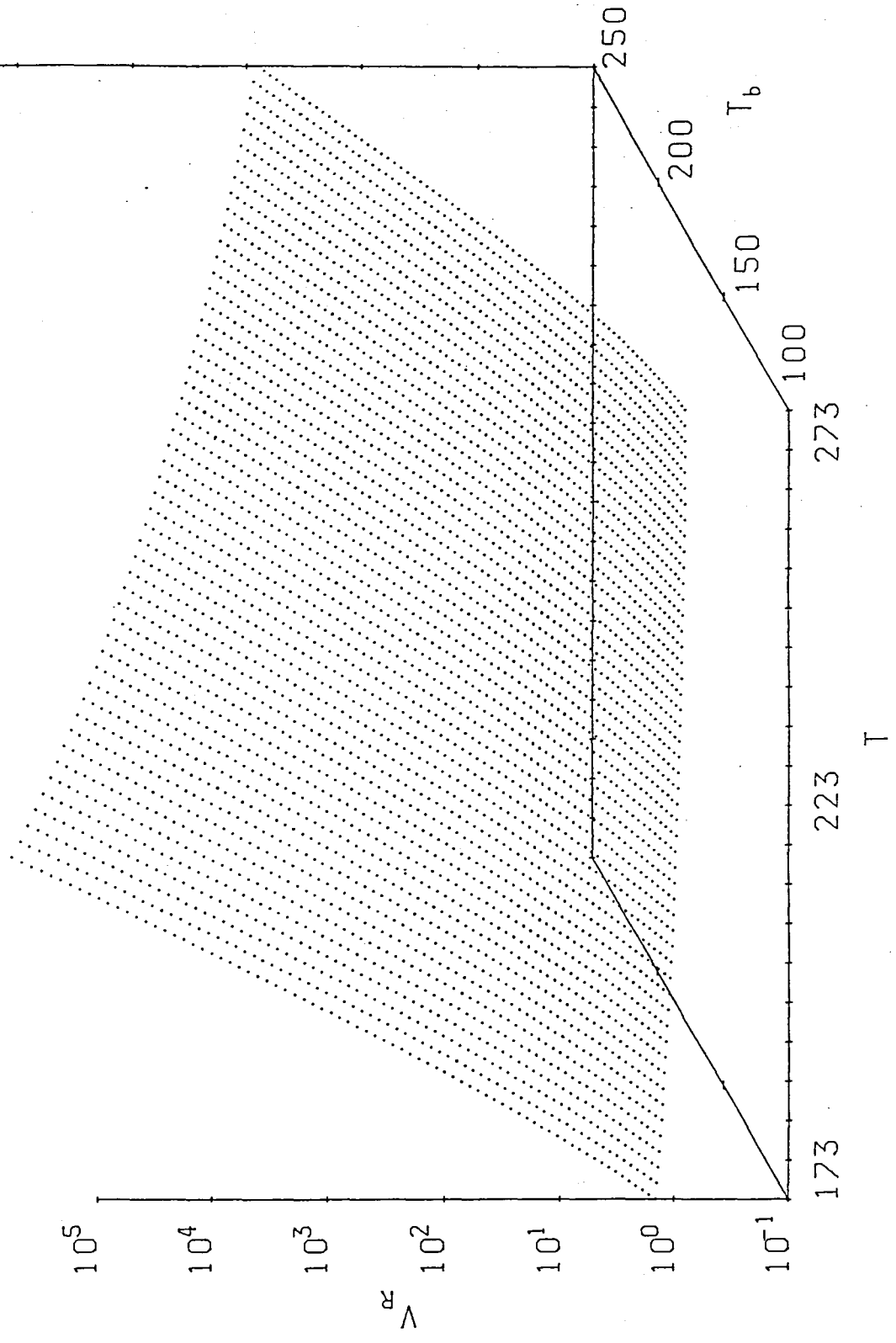

Fig. III-6. Relation between  $V_R$ ,  $T_b$  and  $T$  on squalene.

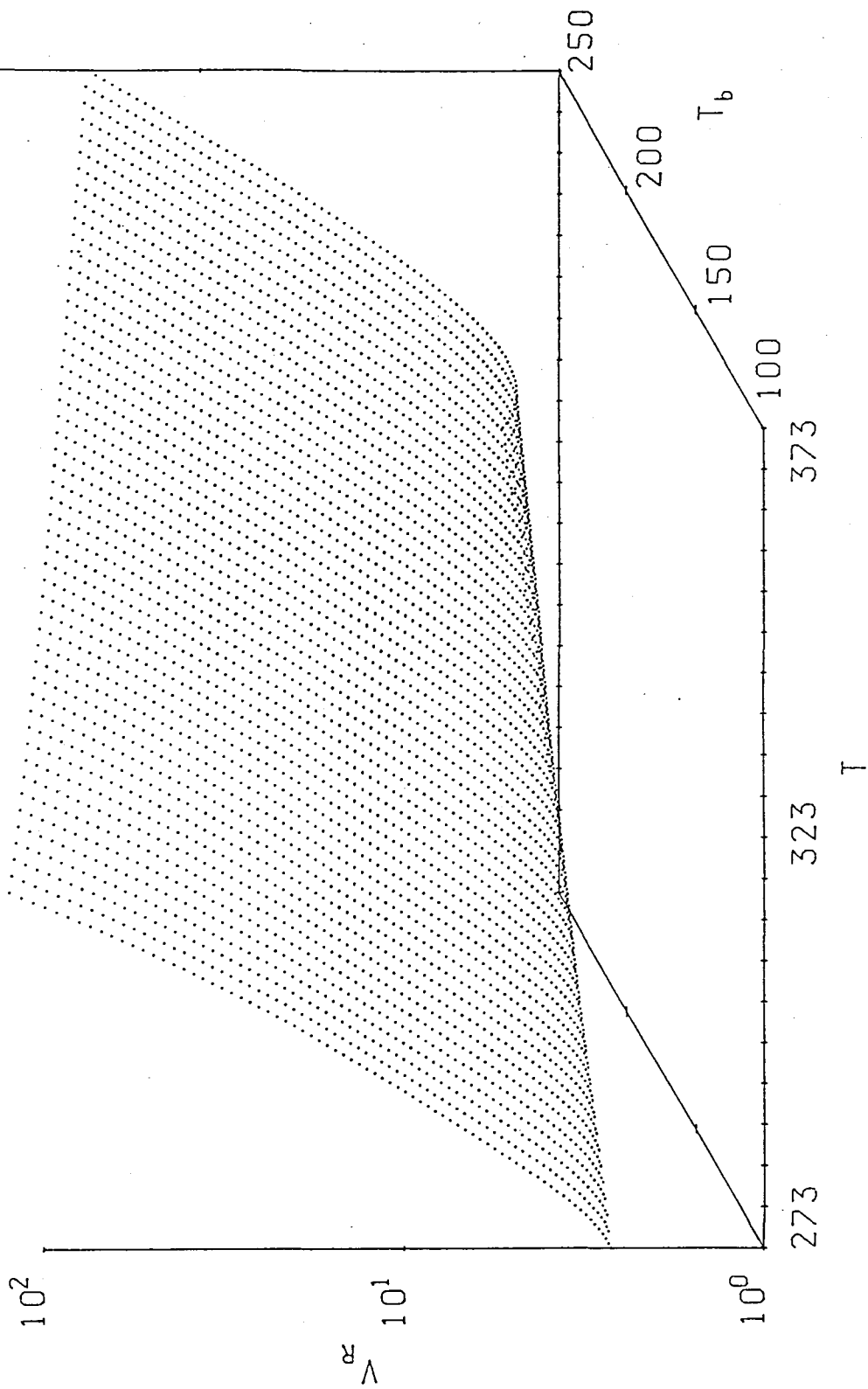

Fig. III-7. Relation between  $V_R$ ,  $T_b$  and  $T$  on PEG 1500



$V_R$ , which is calculated from the semi-empirical theory when squalene is chosen. Fig. III-7 shows the variation of  $V_R$  when PEG 1500 is chosen. From these figures it is obvious that the retention volumes are very small at lower column temperatures than the boiling points of the objects. The freezing point of PEG 1500 is around 317 K, and it is seen from Fig. III-7 that the retention volume of Rn is about  $10 \text{ cm}^3$  near the temperature. Thus, the boiling point of Rn can be estimated even at fairly high temperature.

Further, it is understandable from these figures that the estimated boiling point has a small error even when the error of the retention volume is fairly large. This is due to the steep slope of  $V_R$  vs.  $T_b$  line at given  $T$ . The error of  $T_b$  listed in Tables III-2 and III-3 is due to the error of retention volume only.

### D-3. Disagreement between the Boiling Point of Rn Obtained and That Given in Literatures

The boiling point of Rn obtained in the present work is  $198 \pm 2 \text{ K}$  and is lower by 13 K than those extrapolated from the lighter rare gases and measured by Gray and Ramsay. This shows the same tendency that was observed on  $\text{At}_2$ . This may imply that the intermolecular forces of typical elements

in the 6th period has a somewhat different tendency from those of the lighter elements in the same group. This will be discussed closely later.

#### IV. DISCUSSION ON THE BOILING POINTS OF ASTATINE AND RADON

##### A. EXTRAPOLATION FROM OTHER ELEMENTS IN THE SAME GROUP

###### A-1. Calculation by Otozai's Empirical Formula

The boiling points of astatine and radon, which were obtained in the present study, were far lower than those extrapolated from other elements, and further for Rn it was lower than the values obtained on the basis of vapor pressure. Thus in this section the boiling points, which are estimated from other elements in the same group, are discussed.

Probably it is the most popular method to find the relation between boiling points and period numbers ( $m$ ) in the periodic table. In Fig. IV-1 the relations of  $T_b$  vs.  $m$  are shown on both halogens and rare gases. It is seen from the figure that the boiling point zigzag increases with increase of  $m$ . The degree of zigzag is more remarkable in

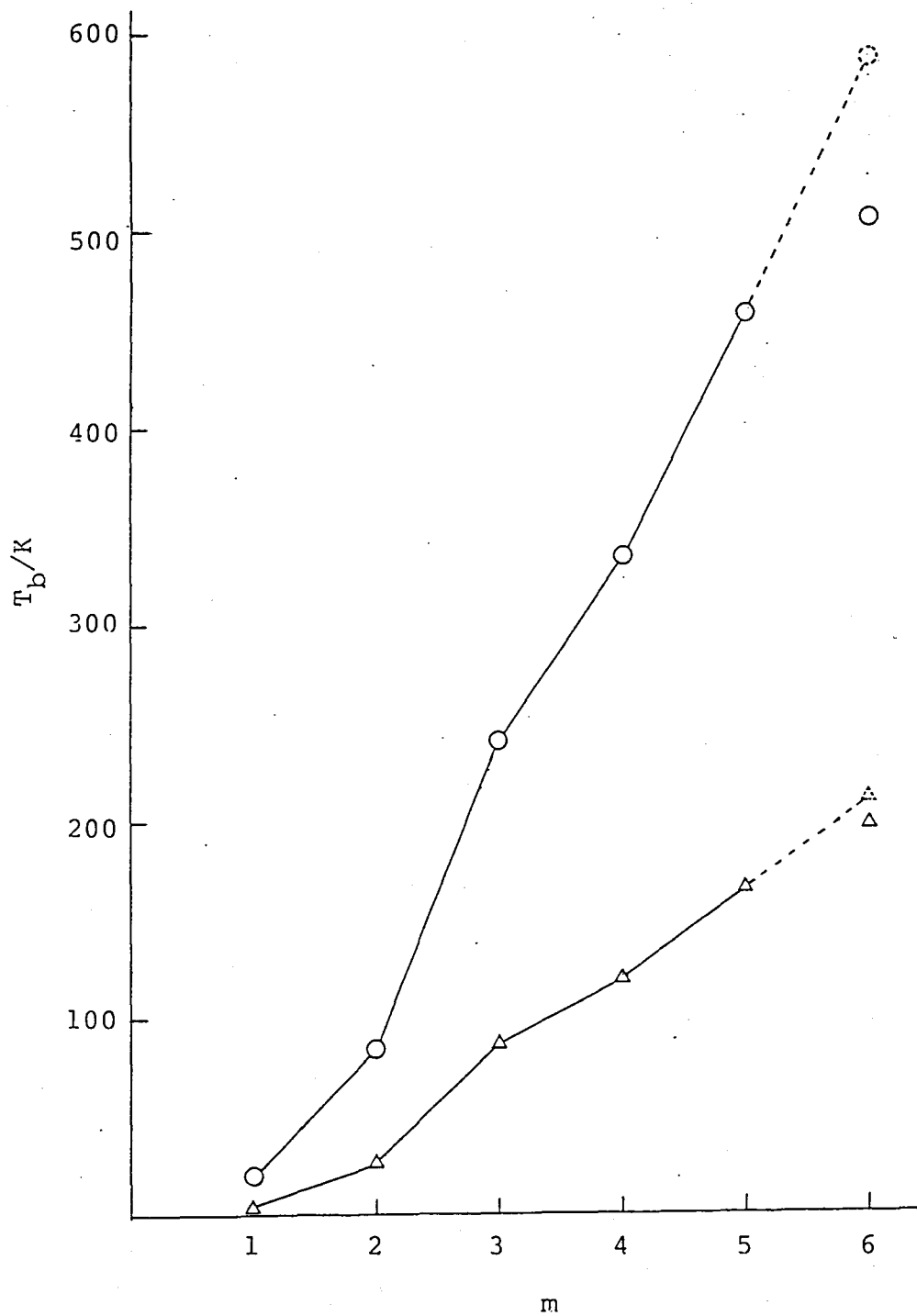

Fig. IV-1. Boiling points of halogens and rare gases (linear scale).  
 ○ : halogen, △ : rare gas.  
 Dashed lines indicate the extrapolation.

halogens than rare gases. It is difficult to estimate simply an unknown boiling point due the effect. One may find the regularity of the zigzag with  $m$ , (the degree decreases with the increase of  $m$ ).

Now, the next empirical formulae on  $T_b$  were led by Otozai[IV-1]. Rare gas sample was the most suitable for leading the empirical relation of  $T_b$  with atomic number ( $Z$ ), because it condenses only by the van der Waals force due to the absence of ionic, permanent dipole and metallic interactions. For the rare gas group the empirical formula

$$T_b = 26.5 R - 33$$

was obtained with

$$R = (Z + f)^{1/2},$$

where  $f$  is defined as

$$f = [30.8 \cos m\pi/m\pi][1.15 \sin^2(m/2)\pi \{ \exp(0.548(1 - m)) - 1 \} - \cos^2(m/2)\pi].$$

In these equations the zigzag effect is corrected by a parameter  $f$ . For halogens the  $T_b$  was represented as

$$T_b = 53m^{0.317}(Z + f)^{1/2} - 33.$$

In Table IV-1 the values, which are obtained with the equations are listed for halogens and rare gases. Further, the experimental values in the present study and the others [IV-2] are listed too. Although the calculated values agree well with experimental values up to the fifth period in both halogens and rare gases, discrepancies were found between the calculated and experimental values at the sixth period. So this method may not be applied above the sixth period on both halogens and rare gases.

#### A-2. Relation between the Boiling Point and the Period Number

In the above calculation the zigzag pattern was well corrected by using a parameter  $f$  and the relation between the boiling points and the atomic numbers was found except for the samples in the sixth period. On the other hand, the linear relation between  $\ln T_b$  and  $m$  is hold in the region of large period numbers as shown in Fig. IV-2. In this figure good linearity of  $\ln T_b$  vs.  $m$  is found among the 3d, 4th and 5th period groups (the linearity is not found among the 1st, 2nd and 3d period groups).

Table IV-1. Boiling points of halogen and rare gas

m	f	halogen			rare gas		
		Z	T <sub>b</sub> (K)		Z	T <sub>b</sub> (K)	
			calc.	expt.		calc.	expt.
1	0	1	20	20.28 <sup>a)</sup>	2	4	4.22 <sup>a)</sup>
2	-4.90	9	85	85.01 <sup>a)</sup>	10	27	27.10 <sup>a)</sup>
3	+2.50	17	239	238.55 <sup>a)</sup>	18	87	87.45 <sup>a)</sup>
4	-2.45	35	333	331.93 <sup>a)</sup>	36	120	120.85 <sup>a)</sup>
5	+2.00	53	457	457.5 <sup>a)</sup>	54	165	166.05 <sup>a)</sup>
6	-1.63	85	586	503 <sup>b)</sup>	86	210	198 <sup>b)</sup>
7	+1.55	117	720	-	118	257	-

a) Given in Ref. [IV-2].

b) Obtained in the present study.

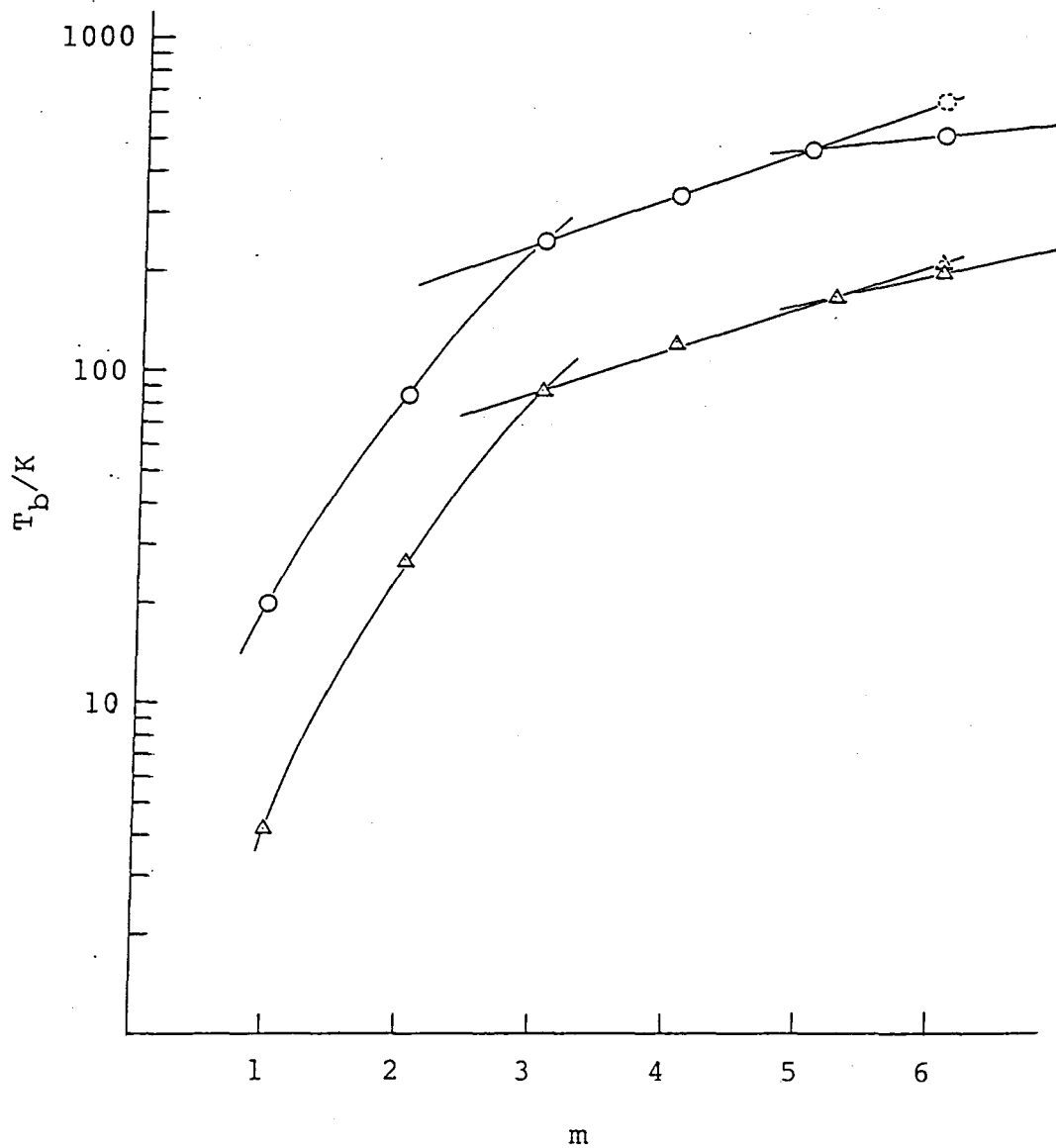

Fig. IV-2. Boiling points of halogens and rare gases (log scale).

○: halogen,    △: rare gas.



Thus we tried to fit these values with a linear equation by the least squares method, and the following equations were obtained from the data of the 3d, 4th and 5th periods. For halogens  $T_b$  is expressed as

$$\ln T_b = 0.325m + 4.502. \quad (\text{IV-1})$$

For rare gases

$$\ln T_b = 0.321m + 3.507 \quad (\text{IV-2})$$

is obtained. For the 3d, 4th and 5th periods the values estimated by these equations and experimental values are tabulated in Table IV-2 for halogens and rare gases. This method gives boiling point much higher than the present experimental values for the elements of the 6th period.

#### B. ON THE SEMI-EMPIRICAL FORMULA BETWEEN BOILING POINTS AND RETENTION VOLUMES IN GAS CHROMATOGRAPHY

The boiling points of astatine and radon were obtained by using the semi-empirical theory on the retention volume. The formula has been tested on halogens[IV-1] and was

Table IV-2. Estimated boiling points by least squares method

m	halogen			rare gas		
	element	T <sub>b</sub> (K)		element	T <sub>b</sub> (K)	
		calc.	expt.		calc.	expt.
3	Cl <sub>2</sub>	239	238.55	Ar	87	87.45
4	Br <sub>2</sub>	331	331.93	Kr	121	120.85
5	I <sub>2</sub>	459	457.5	Xe	166	166.05
6	At <sub>2</sub>	635	503	Rn	229	198
7	Eka-At <sub>2</sub>	880	-	Eka-Rn	316	-

checked using xenon in the present study. Thus it must be applicable to At<sub>2</sub> and Rn. But the boiling points of At and Rn obtained couldn't be explained by the extrapolation of the other elements in the same groups. Thus we come to a conclusion that the boiling point of the 6th period may be much lower than that extrapolated.

There is another possibility, however; that is, it may be considered that the semi-empirical formula does not hold on At<sub>2</sub> and Rn. The successive discussion is done from the point of view. The solubility parameter of solute ( $\delta$ ) was expressed as  $\delta = (eT^{1/4} - f) + (i/T_b^4 - j)$ , which was shown in Appendix (i). Although the values of  $\delta$  are well known on popular samples in general, they are not given exactly as a function of temperature. So the  $\delta$  was represented as a function of  $T_b$  semi-empirically. Since on both halogens and rare gases the boiling points estimated by the semi-empirical formula well agree with those of other experiments except for At<sub>2</sub> and Rn, it is concluded that the formula of  $\delta$  holds well in these elements. One may reckon that above formula doesn't hold for At<sub>2</sub> and Rn. But it is quite unlikely that the regularity of the solubility doesn't hold only in the cases of At<sub>2</sub> and Rn.

C. CONSIDERATION ON THE BOILING POINT WITH RELATION  
TO THE EFFECTIVE NUCLEAR CHARGE

An linear relationship exists between  $\ln T_b$  and  $m$  as shown in Fig. IV-2, and large changes are found in the slopes of the lines before and after  $m = 3$  both in halogens and rare gases. Furthermore these changes are also found at  $m = 5$  if the presently obtained values are take into consideration. If the values obtained in this study are correct, this behavior of the boiling points may be correlated qualitatively to the configuration of electrons on the elements, because at  $m = 4$  and  $m = 6$  the d-orbital and f-orbital are first fulfilled, respectively.

The wave function, which discribes a many-electron system, can be approximately constructed of a hydrogen-like wave function, which has an effective nuclear charge. The difference between the real and the effective nuclear charge is called as a screening constant (S). The radial part of the wave function of one electron has been simply expressed by Slater[IV-3] as

$$r^{n^*-1} e^{-((Z - S)/n^*r)}.$$

It is an asymptotic form at large distances for a hydrogen-like wave function of quantum number  $n^*$  in the field of a nuclear charge  $(Z - S)$ .

The values of  $n^*$  and  $(Z - S)$  are given by following rules in literature[IV-3]:

(1)  $n^*$  is assigned by the following table, in terms of the real principal quantum number  $n$ :

for  $n = 1, 2, 3, 4, 5, 6$

$n^* = 1, 2, 3, 3.7, 4.0, 4.2$

(2) For determining  $(Z - S)$ , electrons are divided into the following groups, each having different shielding constant:  $1s$ ;  $2s, p$ ;  $3s, p$ ;  $3d$ ;  $4s, p$ ;  $4d$ ;  $4f$ ;  $5s, p$ ;  $5d$ ; etc.

(3) The shielding constant  $S$  is formed, for any group of electrons, from the following contributions:

(a) Nothing from any shell outside the one considered.

(b) An amount 0.35 from each other electron in the group considered (except in the  $1s$  group, where 0.30 is used instead).

(c) If the shell considered is an  $s, p$  shell, an amount 0.85 from each electron with the total quantum number less by one, and an amount 1.00 from each electron still further in; but if the shell is  $d$  or  $f$ , an amount 1.00 from every electron inside it.

In Table IV-3 Slater's  $(Z - S)$  and  $S$  are listed for

Table IV-3. Slater's effective nuclear charges and screening constants for p-orbital electrons

m	orbital	halogen		rare gas	
		Z - S	S	Z - S	S
1	1s	1	0	1.70	0.30
2	2p	5.2	3.8	5.85	4.15
3	3p	6.1	10.9	6.75	11.25
4	4p	7.6	27.4	8.25	27.75
5	5p	7.6	45.4	8.25	47.75
6	6p	7.6	77.4	8.25	77.75

p-orbital electrons of halogens and rare gases.

Separately from Slater, Pauling has been obtained a series of screening constants[IV-4], which were estimated from x-ray terms and mole refraction by semi-empirical considerations. According to Pauling the many physical properties of elements are expressed as a function of  $(Z - S)$ . The property, which for a hydrogen-like atom is found to vary with  $n^r Z^{-t}$ , has been considered by Pauling[IV-5].

The screening constant for this property would be such that

$$\text{const.} \cdot n^r Z^{-t} = \text{const.} \cdot n^r (Z - S)^{-t}.$$

Here,  $S$  is expressed as

$$S = \sum_i Z_i - \frac{\epsilon}{\gamma_i} \sum_i Z_i D_i,$$

in which  $D_i$ , called the unit screening defect for an electron in the  $i$ th shell, is given by the equation

$$D_i = \frac{1}{\pi} \{ \beta_i u_i + (1 + \beta_i) \epsilon \sin u_i \} - \beta_i$$

with

$$1 + \epsilon \cos u_i = \frac{\gamma_i n_i^2}{n^2}$$

and

$$\beta_i = \frac{n^2}{\gamma_i n_i} - 1.$$

The path of an electron in the  $i$ th region is a segment of Kepler ellipse defined by the segmentary radial and the azimuthal quantum number  $n'$  and  $k$ , so that it can be described as follows:

$$r = \frac{a_0 k^2}{Z_i} \cdot \frac{1}{(1 - \epsilon_i \cos \varphi)} = \frac{a_0 n_i^2}{Z_i} (1 + \epsilon_i \cos u).$$

$$t = \frac{n_i^2}{4\pi R Z^2} (u + \epsilon_i \sin u).$$

In these equations  $\varphi$  and  $u$  are the segmentary true anomaly and excentric anomaly, respectively, measured from aphelion, while  $n_i$  and  $\epsilon_i$  are the segmentary principal quantum number and the excentricity given by the equations

$$n = n' + k, \quad \epsilon = \sqrt{1 - \frac{k^2}{n_i^2}}.$$

Pauling's  $(Z - S)$  and  $S$  are listed in Table IV-4 for p-orbital electrons of halogens and rare gases. He explained well the physical properties of elements (e.g.,



sizes of atoms and ions, mole refraction, diamagnetic susceptibility etc.) by using the values.

Since the values of  $(Z - S)$ , which is given by Slater's rule, saturate and equal to 7.6 and 8.25 on halogens and rare gases, respectively, this cannot explain the present discrepancy of the boiling points at the 6th period. On the other hand, Pauling's values obviously begin to change at  $m = 5$  in both halogenes and rare gases as shown in Figs. IV-3 and IV-4 (it is not clear at the 3d period). This phenomenon is identical with the variation of the boiling points of halogen and rare gas groups.

Thus, we attempted to represent the boiling points as a function of  $(Z - S)$ . On the boiling points of the elements in 5th, 6th and 7th periods the following equations are obtained with considering the effective nuclear charge:  
For halogens

$$T_b = 32.1(Z - S) + 45.9, \quad (\text{IV-3})$$

and for rare gases

$$T_b = 16.7(Z - S) + 36.7 \quad (\text{IV-4})$$

are obtained. The values estimated from these equations are listed in Table IV-5. Estimated values agreed well with

Table IV-4. Pauling's effective nuclear charges and screening constants for p-orbital electrons

m	orbital	halogen		rare gas	
		Z - S	S	Z - S	S
1	1s	1	0	1.81	0
2	2p	4.85	4.15	5.43	4.57
3	3p	6.6	10.4	7.1	10.9
4	4p	8.9	26.1	9.4	26.2
5	5p	11.9	41.1	12.2	41.8
6	6p	13.2	71.8	14	72
7	7p	16	101	17	101

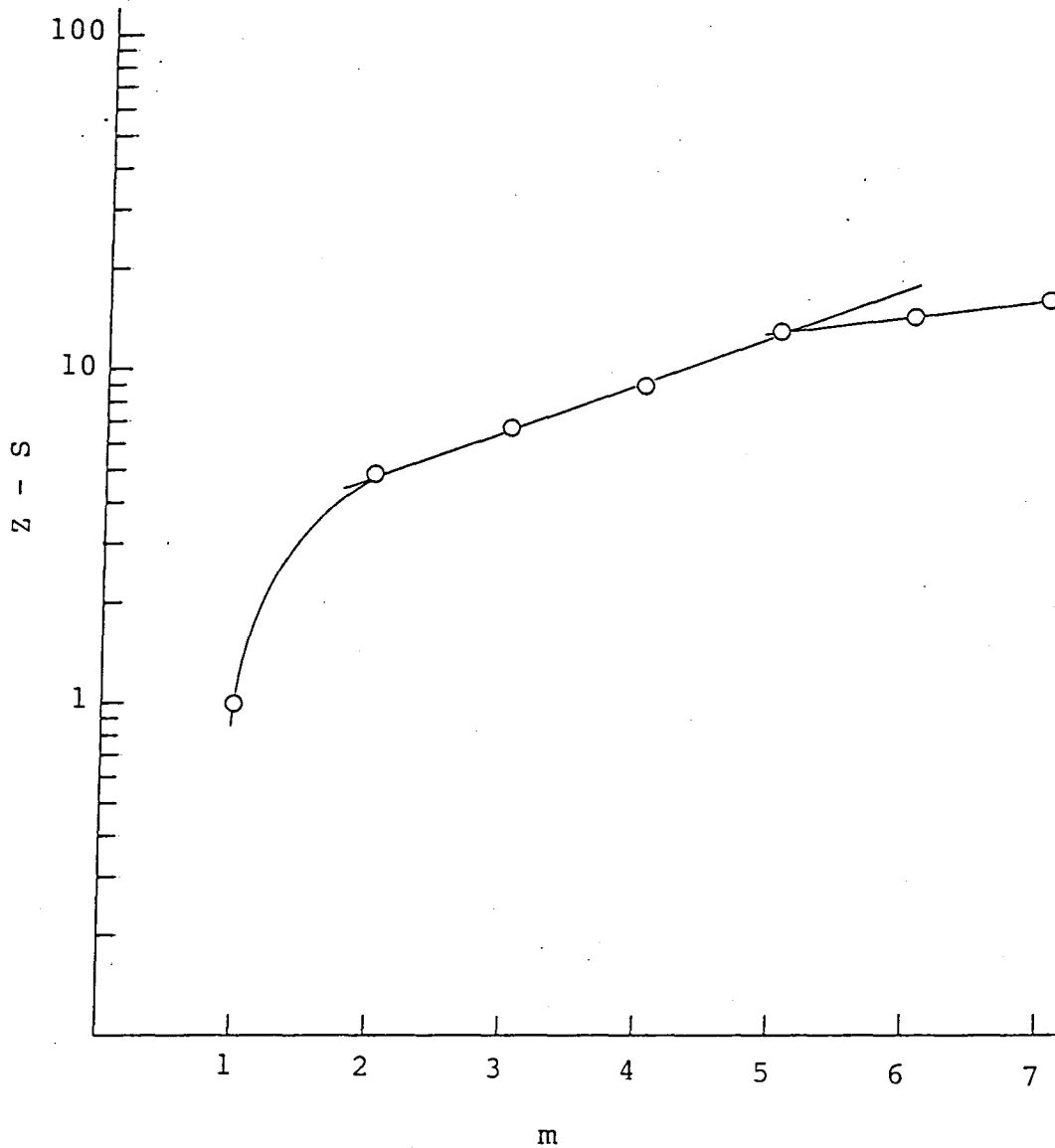

Fig. IV-3. Effective nuclear charges for p-orbital electrons of halogens.

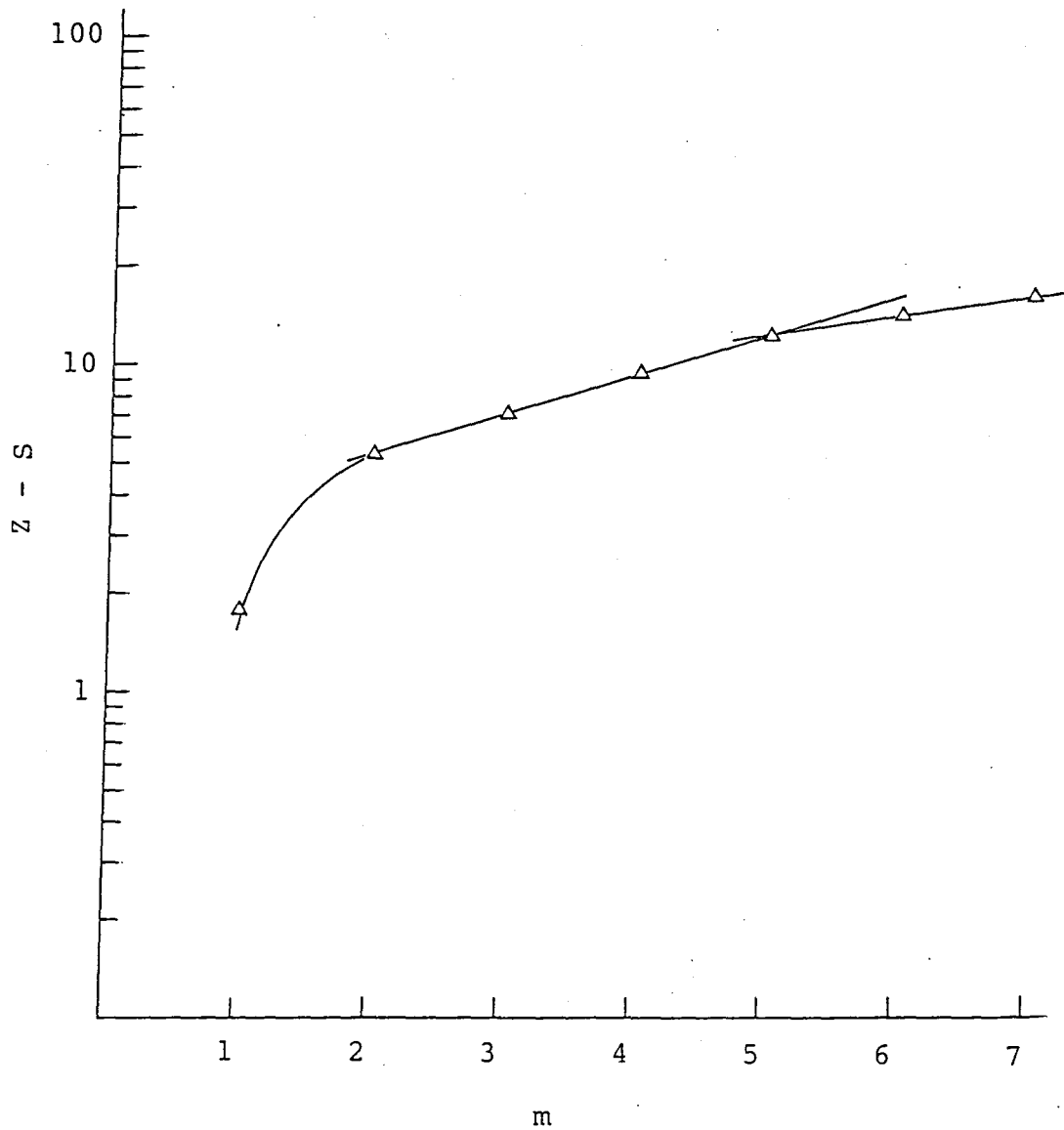

Fig. IV-4. Effective nuclear charges for p-orbital electrons of rare gases.

Table IV-5. Boiling points of halogens and rare gases

m	halogen			rare gas		
	element	$T_b$ (K)		element	$T_b$ (K)	
		calc.	expt.		calc.	expt.
4	Br <sub>2</sub>	331	331.93	Kr	120	120.85
5	I <sub>2</sub>	459	457.5	Xe	167	166.05
6	At <sub>2</sub>	501	503	Rn	197	198
7	Eka-At <sub>2</sub>	559	-	Eka-Rn	247	-

experimental values in both halogens and rare gases at the 5th and 6th periods. Moreover the values agreed well even at the 4th period. For reference, the predicted values for the 7th period are fairly lower than those expected by other extrapolation methods.

In conclusion, we have found a close relationship between the observed boiling point and the screening constant which is based on some physical or physicochemical concepts. Now that it is quite conceivable that the evaporation phenomenon is strongly influenced by the electronic configuration of the molecule, we have a good reason to believe that the present work gave correct boiling points both halogen and rare gas groups. This proves in turn that Otozai's empirical formula is reliable even for the 6th period and very likely for higher periods.

## ACKNOWLEDGEMENTS

I wish to thank Professor Kiyoteru Otozai for his untiring support and encouragement throughout the trials and tribulations of this work. I also want to thank Professor Hiroshi Baba and Professor Shigero Ikeda for many helpful discussions and not inconsiderable practical assistance.

Thanks are due to the crew of the Osaka University, Laboratory of Nuclear Studies cyclotron for the production of astatine.

I am greatly indebted to Abe Shoji Ltd. for providing the gas chromatographic apparatus, and Dr. Ichiro Tohyama for his helpful discussion on the gas chromatography.

During the last year of this work I was the recipient of a Yukawa Foundation Fellowship, for which I want to express my appreciation.

## REFERENCES

### References for I.

- I-1. K. Otozai, *Z. Anal. Chem.* 279, 195 (1976).
- I-2. A. V. Grosse, *J. Inorg. Nucl. Chem.* 27, 509 (1965).
- I-3. R. T. Meyer, *J. Phys. Chem.* 83, 294 (1979).
- I-4. R. W. Kiser, *J. Chem. Phys.* 35, 1265 (1960).
- I-5. G. L. Johnson, R. F. Leininger and E. Segre, *J. Chem. Phys.* 17, 1 (1949).
- I-6. H. M. Neumann, *J. Inorg. Nucl. Chem.* 4, 349 (1957).
- I-7. E. H. Appleman, *J. Am. Chem. Soc.* 83, 805 (1961).
- I-8. M. Parrot, W. M. Garrison, P. W. Durvin, H. S. Powell and J. G. Hamilton, U. S. At. Energy Comm. UCRL-3065 (1955).
- I-9. E. T. Storm, U. S. At. Energy Comm. UCRL-9372 (1960).
- I-10. E. H. Appelman, U. S. At. Energy Comm. NAS-NS 3012 (1960).
- I-11. E. H. Appelman, UCL-9025 (1960).
- I-12. A. H. W. Aten Jr., T. Doorgeest, V. Hollstein and P. H. Moeken, *Analyst* 77, 774 (1952).



- I-13. A. H. W. Aten Jr., J. G. van Raaphort, G. Noocheboom and G. Blasse, *J. Inorg. Nucl. Chem.* 15, 198 (1960).
- I-14. L. Stein, *J. Am. Chem. Soc.* 91, 5396 (1969).
- I-15. L. Stein, *Science* 168, 362 (1970).
- I-16. E. R. White and H. G. Davis, *Anal. Chem. Acta*, 34 (1966).
- I-17. A. Karmen, I. McCaffrey and R. L. Bowman, *J. Lipid Res.* 4, 108 (1963).
- I-18. R. Wolfgang and F. S. Rowland, *Anal. Chem.* 30, 903 (1958).

#### References for II

- II-1. D. R. Corson, K. McKnzie and E. Segre, *Phys. Rev.* 58, 672 (1940).
- II-2. H. M. Neumann, *J. Inorg. Nucl. Chem.* 4, 349 (1957).
- II-3. E. K. Hyde, *J. Chem. Educ.* 36, 15 (1958)
- II-4. Yu. V. Norseseyev and V. A. Kahlkin, *J. Inorg. Nucl. Chem.* 36, 3239 (1968).
- II-5. E. H. Appelman, *J. Am. Chem. Soc.* 83, 805 (1961).
- II-6. W. T. Reytl and K. W. Valli, *Nucl. Phys.* A197, 405 (1967).
- II-7. R. W. Hoff, F. Asaro and I. Perlman, *J. Inorg. Nucl. Chem.* 25, 1303 (1963).

- II-8. R. M. Latimer, G. E. Gordon and T. D. Thomas, J. Inorg. Nucl. Chem. 17, 1 (1961).
- II-9. J. D. Stickler and K. J. Hofstetter, Phys. Rev. C9, 1064 (9174).
- II-10. P. E. Thorensen, F. Asaro and I. Perlman, J. Inorg. Nucl. Chem. 16, 1342 (1964).
- II-11. G. W. Barton Jr., A. Ghiorso and I. Perlman, Phys. Rev. 82, 13 (1951).
- II-12. W. J. Ramler, J. Wing, D. J. Henderson and J. R. Huizenga, Phys. Rev. 114, 154 (1959).
- II-13. D. R. Corson, K. McKenzie and E. Segre, Phys. Rev. 58, 672 (1940).
- II-14. W. B. Jones, Phys. Rev. 130, 2042 (1963).
- II-15. J. Borggreen, K. Valli and E. K. Hyde, Phys. Rev. C2, 184 (1970).
- II-16. W. W. Meinke, A. Ghiorso and G. T. Seaborg, Phys. Rev. 75, 314 (9149).
- II-17. A. C. English, T. E. Cranshaw, P. Demers, J. A. Harvey, E. P. Hincks, J. V. Jelley and A. N. May, Phys. Rev. 72, 253 (1947).
- II-18. E. K. Hyde and A. Ghiorso, Phys. Rev. 90, 267 (1953).
- II-19. E. H. Appelman, U. S. At. Energy Comm. NAS-NS 3012 (1960).
- II-20. A. H. W. Aten Jr., Adv. Inorg. Chem. Radiochem. 6, 207 (11963).

- II-21. E. H. Appelman, E. N. Sloth and M. H. Studier, *Inorg. Chem.* 5, 766 (1966).
- II-22. N. A. Golovkov, I. I. Gromova, M. Janicki, Yu. V. Norseyev, V. G. Sandukovsky and L. Vasaros, *Radiochem Radioanal. Lett.* 44, 67 (1980).
- II-23. G. Samsom and A. H. W. Aten Jr., *Radiochim. Acta* 12, 55 (1969).
- II-24. G. J. Meyer, K. Rossler and G. Stocklin, *Radiochem. Radioanal. Lett.* 21, 247 (1975).
- II-25. R. Wolfgang, and F. S. Rowland, *Anal. Chem.* 30, 903 (1976).
- II-26. J. Rudolph and K. Bachman, *Radiochem. Acta* 27, 105 (1980).
- II-27. K. Otozai, *Z. Anal. Chem.* 268, 257 (1974).
- II-28. K. Otozai and I. Tohyama, *Z. Anal. Chem.* 274, 353 (1975).
- II-29. K. Otozai and I. Tohyama, *Z. Anal. Chem.* 281, 131 (1976).
- II-30. K. J. Hofstetter and J. D. Stickler, *Phys. Rev.* C9, 1072 (1974).

### References for III

- III-1. P. Horunsoj and K. Wilsky, Nucl. Phys. A163, 277 (1971).
- III-2. K. Valli, M. J. Nurmia and E. K. Hyde. Phys. Rev. 159, 1013 (1967).
- III-3. A. W. Stoner and E. K. Hyde, J. Inorg. Nucl. Chem. 4, 77 (1967).
- III-4. W. W. Meinke, A. Ghiorso and G. T. Seaborg, Phys. Rev. 86, 805 (1952).
- III-5. F. F. Momyer Jr., and E. K. Hyde, J. Inorg. Nucl. Chem. 1, 267 (1955).
- III-6. E. K. Hyde, A. Ghiorso and G. T. Seaborg, Phys. Rev. 77, 765 (1950).
- III-7. D. F. Togerson and R. D. Macfarlane, Nucl. Phys. A149, 641 (1970).
- III-8. W. W. Meinke, A. Ghiorso and G. T. Seaborg, Phys. Rev. 85, 429 (1952).
- III-9. E. K. Hyde, I. Perlman and G. T. Seaborg, The Nuclear Properties of the Heavy Elements; vol II, Prentice Hall Inc., New Jersey (1964).
- III-10. A. V. Bellide, J. Inorg. Nucl. Chem. 19, 197 (1961).

- III-11. P. G. Hansen, P. Hornsoj, H. L. Nielsen, H. Kugler, G. Astner, E. Hagebo, J. Hadis, A. Kjelberg, F. Munnich, P. Patzelt, M. Alpsten, G. Anersson, Aa. Appelqvist, B. Bengtsson, R. A. Naumann, O. B. Mielsen, E. Beck, R. Foucher, J. P. Husson, J. Jastrzebski, A. Johnson, J. Alstad, T. Jahnsen, A. C. Pappas, T. Tanaul, R. Henck, P. Shiffert and G. Rudstain, *Phys. Lett.* 28B, 425 (1969).
- III-12. H. A. C. McKey, *Principle of Radiochemistry*, Butterworth, London (1971).
- III-13 N. Batlett, *Proc. Chem. Soc.* 1962, 218 (1962).
- III-14. E. Rutherford, *Nature* 79, 457 (1909).
- III-15. R. W. Gray and W. Ramsay, *J. Chem. Soc.* 95, 1073 (1909).
- III-16. L. Wertenstein, *Proc. Roy. Soc.* A150, 395 (1935).
- III-17. K. Otozai, *Z. Anal. Chem.* 268, 257 (1974).

#### References for IV

- IV-1. K. Otozai and I. Tohyama, *Z. Anal. Chem.* 279, 195 (1976).
- IV-2. R. C. Weast, *Handbook of Chemistry and Physics*, 59th edit., CRC Press Inc., Florida (1978).
- IV-3. J. C. Slater, *Phys. Rev.* 36, 57 (1930).

IV-4. L. Pauling and J. Sherman, Z. f. Krist. 81, 1 (1932).

IV-5. L. Pauling, Proc. Roy. Soc. A114, 181 (1927).

APPENDIX

APPENDIX (i)

SEMI-EMPIRICAL THEORY ON THE RETENTION VOLUME IN GAS  
CHROMATOGRAPHY

APPENDIX (ii)

REACTION MECHANISMS OF ELEMENTARY ASTATINE WITH SOME  
ORGANIC SOLVENTS

APPENDIX (iii)

DETERMINATION OF THE MOLECULAR WEIGHT AND SOLUBILITY  
PARAMETERS OF HIGH-POLYMERS BY GAS CHROMATOGRAPHY

APPENDIX (i)

SEMI-EMPIRICAL THEORY ON THE RETENTION VOLUME  
IN GAS CHROMATOGRAPHY[i-1]

It has been found that the retention volume in the gas-liquid partition elution gas chromatography has a close correlation with the boiling point of the sample[i-2 to i-6]. It was attempted to obtain a quantitative expression for the relation by a semi-empirical method (e.g., by the plate theory on retention volume, the regular solution theory and some empirical rules to supply the theories). The practical form of the theory is as follows:

$$\ln V_R = \ln ZRTN\vartheta + Z(1 + hr)\epsilon - r + \{1 - Z(1 + h)\epsilon\}rT_b/T, \quad (i-1)$$

$$Z = 1 + h\{d - c(T_b/T)^2\}(T_b/TR)\exp\{r(1 - T_b/T)\}, \quad (i-2)$$

$$\vartheta = 100, \quad h = 1/\{1 + (1/aT_b^4 - 1)T/T_b\} + 1/\ln T_b T, \quad (i-3)$$

$$r = \mu(aT_b^4 + b)\{1 + aT_b^4(T_b/T - 1)\}T^{1/8} \ln T_b / \ln T_b T, \quad (i-4)$$



$$\epsilon = (\beta\delta_s/\delta - 1)^2, \delta = (eT_b^{1/4} - f) + (i/T_b - j), \quad (i-5)$$

$$\beta = \{1 + 1.3(\delta - 5.9)/\delta_s\} / \{1 + 0.05(\bar{\delta} - 5.9)\}. \quad (i-6)$$

For non-associated sample solutes, for example,  $a = 4 \times 10^{-12}$ ,  $b = 10.35$ ,  $c = 3.45$ ,  $d = 0.15$ ,  $e = 1.87$ ,  $f = 0.75$ ,  $i = 0$ ,  $j = 0$  and  $\mu = 1$ . The derivation of the theory will be mentioned below in detail.

The usual idealization for low vapor pressure, which leads to the ideal gas behavior and disregard of the molar volume of liquid compared with that of gas, is tried to be amended as far as possible. However, the assumption of dilute solution is left as it is, because of the difficulty for correction.

The formula for retention volume by the plate theory [i-7] is corrected for the deviation from the ideal gas behavior as

$$V_R = ZRTN/\gamma P, \quad (i-7)$$

where  $V_R$  ( $\text{cm}^3$ ) is the absolute retention volume,  $Z$  is the compressibility factor ( $Pv_g = ZRT$  for gas low),  $P$  (atm) is

the vapor pressure of pure liquid solute,  $v_g$  ( $\text{cm}^3/\text{mol}$ ) is the molar volume in gas state,  $R$  is the gas constant,  $T(\text{K})$  is the column temperature,  $N$  (mol) is moles of solvent in the column and  $\gamma$  is the activity coefficient of solute in the solution at infinite dilution based on Raoult's law.

Under the assumption of low vapor pressure, Hildebrand rule,  $\Delta S^V = R(1 + \text{Cln}v_g)$ , is derived. Putting this formula into the Clapeyron-Clausius equation,  $dP/dt = \Delta S^V/\Delta v$ , a solution  $\ln P = q\{1 - (T_b/T)\}$  is obtained with a good approximation in the Taylor expansion. Here,  $\Delta S^V$  (cal/deg. mol) is the entropy of vaporization,  $C$  is a constant,  $\Delta v = v_g - v_l$ ,  $T_b$  (K) is boiling point and  $q = 1 + \text{Cln}RT$ . In order to correct for the assumption of low vapor pressure, an expression:

$$\ln P = r(1 - T_b/T) \quad (\text{i-8})$$

is assumed, leading the theoretical factor  $1 - T_b/T$  as it is, and searching the contents of  $rT_b/T$  empirically as mentioned below.

According to the regular solution theory[i-8, 9] the solubility parameter  $\delta$  ( $\text{cal}^{1/2}\text{cm}^{-3/2}$ ) is defined as  $\delta = (-E_\rho/v_\rho)^{1/2}$ , where  $E$  (cal/mol) is the cohesive energy. If van der Waals equation,  $-E = a/v$ , is assumed  $\Delta E^V = (-E_\rho) - (-E_g) = a(1/v_\rho) - (1/v_g)$ , and hence  $-E_\rho = a/v_\rho = \Delta E^V/Y$ , where,

$a$  ( $\text{cal.cm}^3\text{mol}^{-2}$ ) is van der Waals constant and  $Y = (v_g - v_l) / v_g$  is the molar volume correction factor. As  $\Delta E^V = \Delta H^V - P\Delta v = \Delta H^V - YZRT$ , and  $\Delta H^V = YZ\Delta H_{\text{app}}^V$  from the Claperon-Clausius equation,  $d\ln p/dT = \Delta H^V/PT\Delta v = \Delta H_{\text{app}}^V/RT$ ,  $\delta$  is expressed as

$$\delta = \{(Z/v_g)(\Delta H_{\text{app}}^V - RT)\}^{1/2}, \quad (\text{i-9})$$

where  $\Delta H_{\text{app}}^V$  ( $\text{cal/mol}$ ) is the apparent heat of vaporization. It is seen that the correction factor  $Y$  disappears in this expression.

Again the regular solution theory gives  $\ln(p/P) = \ln x + (1/RT)v_l\phi_s^2(\delta_s - \delta)^2$  under the assumption of low vapor pressure, where  $p$  ( $\text{atm}$ ) is the vapor pressure of the solute,  $x$  is the mol fraction of solute,  $\phi_s$  is the volume fraction of the solvent and  $\delta_s$  is the solubility parameter of the solvent. Comparing this formula with  $p = \gamma xP$ ,  $\gamma$  is expressed as

$$\ln \gamma = v_l\phi_s^2(\delta_s - \delta)^2/RT. \quad (\text{i-10})$$

As  $\phi_s = 1$  in a dilute solution, and by introducing  $v_l$  in Eq. (i-3) into Eq. (i-4),

$$\ln \gamma = Z(\Delta H_{\text{app}}^V/RT - 1)(\delta_s/\delta - 1)^2 \quad (\text{i-11})$$

is obtained.

In order to cover even non-regular solutions, a parameter  $\beta$  (called non-regularity,  $\beta \geq 1$ ) is introduced, and  $\beta\delta_s$  (called an apparent solubility parameter of solvent) is used instead of  $\delta_s$ . Using the formulae  $\Delta H_{app}^V = RT^2(d\ln P/dT)$  and  $d\ln P/dT = (dr/dT)(1 - T_b/T) + rT_b/T^2$  derived from Eq. (i-2),  $\gamma$  is represented as

$$\ln \gamma = Z \{ (dr/dT)(T - T_b) + rT_b/T - 1 \} \epsilon, \quad (i-12)$$

where  $\epsilon = (\beta\delta_s/\delta - 1)^2$ . Although  $\delta$  decrease as temperature increase, the ratio  $\delta_s/\delta$  does not vary so much with temperature. Hence, the temperature dependence of  $\epsilon$  is not severe.

Based on experimental vapor pressure data of organic [i-10] and inorganic [i-11] compounds, the parameter  $r$  is expressed empirically as follows:

$$r = \rho T_b^{1/8} \ln T_b / \ln T_b T, \quad (i-13)$$

$$\rho = \rho_b \{ 1 + a T_b^4 (T_b/T - 1) \}, \quad (i-14)$$

and

$$\rho_b = \mu(aT_b^4 + b), \quad (i-15)$$

where subscript b is the symbol for the boiling point.

The values of parameters  $\mu$ , a and b are listed in Table i-1. The parameter  $\mu$  may have a physical meaning of effective association. For example, water associated by hydrogen-bond has 1.20 times larger values of  $\rho_{298}$  and  $\Delta H_{298}^V$  than non-associated n-heptane, which has almost the same boiling point as water shown in Table i-2. Here, subscript 298 is the symbol for 298 K.

From Eqs. (i-7) and (i-8)

$$dr/dT = -hr/T, \quad (i-16)$$

where

$$h = 1/\{1 + (1/aT_b^4 - 1)T/T_b\} + 1/\ln T_b T, \quad (i-17)$$

is derived. Putting Eq. (i-10) into Eq. (i-6),  $\gamma$  is finally expressed as

$$\ln \gamma = Z\{(1 + h)rT_b/T - (1 + hr)\} \epsilon. \quad (i-18)$$

Putting Eqs. (i-2) and (i-12) into Eq. (i-1), the retention volume is expressed as

$$\ln V_R = \ln ZRTN + \{Z(1 + hr)\epsilon - r\} + \{1 - Z(1 + h)\epsilon\}rT_b/T. \quad (i-19)$$

Thus,  $V_R$  is semi-empirically expressed with variable  $N$ ,  $\delta$ ,  $T_b$ ,  $T$  and  $\beta\delta_s$ . As mentioned above, the condition of dilute solution was assumed, the non-regularity was introduced, and the assumption of low vapor pressure was largely corrected.

In the case, when solutes and solvents are chemically similar,  $\epsilon$  becomes zero, and so  $V_R$  is expressed as  $\ln V_R = \ln ZRTN - r + rT_b/T$ . As  $T$  and  $N$  are constant under the same column condition, it becomes  $\ln V_R = \text{const} + \text{const} \cdot T_b$  under the assumption that  $Z = 1$  and  $r = \text{const}$ . In such a case  $\ln V_R$  vs.  $T_b$  plots give a straight line.

In order to apply the theory practically,  $Z$  must be calculated. From the formulae  $Pv_g = ZRT$  and  $Pv_g = RT + BP$ , we obtain  $Z = 1 + BP/RT$ , where second virial coefficient  $B$  ( $\text{cm}^2/\text{mol}$ ) is empirically expressed from the experimental data[i-12] as

$$-B/T_b = c(T_b/T)^2 - d. \quad (i-20)$$

The values of parameters  $c$  and  $d$  are listed in Table i-3.

Thus, a formula

$$Z = 1 + \{d - c(T_b/T)^2\}(T_b/T)(1/R) \exp\{r(1 - T_b/T)\} \quad (i-21)$$

is obtained.

The values of  $\delta$  are usually given with two significant figures. To check the theory, however, three significant figures is desirable. The  $\delta$  values which are not available for any temperature[i-13], can be smoothed by an empirical formula:

$$\delta = (eT_b^{1/4} - f) + (iT_b^4 - j). \quad (i-22)$$

The values of parameters e, f, i and j are listed in Table i-4.

The parameter  $\beta\delta_s$  has a proper value for respective combination of the solvent and the chemical group of samples independent of the column temperature. The  $\beta\delta_s$  value is approximately constant for each solvent, but shows some systematic increase with increase of  $\bar{\delta}$ , which is the average value of  $\delta$ 's of the sample in the chemical group. Since is naturally proper to the solvent, systematic increase is due to  $\beta$ . It was found that  $\beta\delta_s$  corrected by  $-\bar{\delta} + 0.05(\beta\delta_s - 5.9)(\delta - 5.9)$  becomes a constant value characteristic of

the solvent and independent of  $\bar{\delta}$ , the nature of the chemical group. Here, the value (5.9) is the smallest value of the ever found experimentally within many substances.

Thus the formula:

$$\begin{aligned} \beta\delta_s \text{ (corrected)} \\ = \beta\delta_s - \bar{\delta} + 0.05(\beta\delta_s - 5.9)(\bar{\delta} - 5.9) \end{aligned} \quad (\text{i-23})$$

is obtained.  $\beta$  deduced from Eq. (i-15) is expressed as

$$\begin{aligned} \beta = 1 + 1.3(\bar{\delta} - 5.9)/\delta_s / \\ \{1 + 0.05(\bar{\delta} - 5.9)\}. \end{aligned} \quad (\text{i-24})$$



Table i-1. Values of parameters  $\mu$ , a and b

Substance	$\mu$	a	b
n-Alkane and other non-associated	1.00	$4 \times 10^{-12}$	10.35
Water	1.20	$4 \times 10^{-12}$	10.35
n-Alkyl alcohol	1.20-1.30	$4 \times 10^{-12}$	10.35

Table i-2. Meaning of parameter  $\mu$

Substances	$T_b$ (K)	$\rho_{298}$	$\Delta H_{298}^V$ (cal/mol)
n-C <sub>7</sub> H <sub>16</sub>	371	10.71	8.75
H <sub>2</sub> O	373	12.87	10.51
Ratio		1.20	1.20

Table i-3. Values of parameters c and d

Substance	c	d
n-Alkane and		
sat. Hydrocarbons	3.45	0.15
SO <sub>2</sub> , CO <sub>2</sub>	2.05	0.15
H <sub>2</sub> O	1.15	0.15

Table i-4. Values of parameters e, f, i and j

Substance	e	f	i	j
n-Alkane	1.87	0.75	0	0
Methyl n-alkyl	1.87	0.75	0	0
ketone	1.87	0.75	$3.63 \times 10^{10}$	0.50
n-Alkyl alcohol	1.87	0.75	$6.60 \times 10^{10}$	-0.98

## APPENDIX (ii)

### REACTION MECHANISMS OF ELEMENTARY ASTATINE WITH SOME ORGANIC SOLVENTS[ii-1]

It has been pointed out that elementary astatine is liable to react with other halogens and organic substances [ii-2]. For example, it was shown by Neumann et al. [ii-3] that astatobenzene was produced when elementary astatine was extracted with benzene. Since elementary astatine tends to react with organic impurities and to be adsorbed on the glassware, the extractability into solvent is not always constant. Appleman et al. [ii-4] have observed some astatine compounds (e.g., HAt, CH<sub>3</sub>At, AtCl, AtBr and AtI) in a plasma ion source. These compounds were identified by means of a time-of-flight mass spectrometer. However, it was difficult to discuss the reaction mechanisms because of the uncertain chemical form of elementary astatine. Since astatine is a short-lived radioisotope, the experiment must be done only at very low concentrations and so the assignment and the determination of the species produced are very difficult in ordinary methods.

Many studies on the reaction of halogens following to

the decay (i.e. known as a hot atom reaction) have been done [ii-5 to ii-10]. Replacement reactions of astatine in benzene and halobenzene following to the EC-decay of radon was studied by Vasaros et al.[ii-11]. Energetic astatine produced by the EC-decay participates in this reaction.

We found that several astatine compounds were always produced when elementary astatine was extracted into benzene[ii-12]. The amounts of the compounds tended to increase up to saturated amounts with increasing the time after extraction, and the rate was closely related to the half life of astatine used[ii-13]. Since the chemical form of elementary astatine had be confirmed[ii-14], the reaction mechanism of elementary astatine with benzene, toluene and monochlorobenzene could be discussed. The compounds were analyzed by means of the RGC, which enabled the assignment and the determination of compounds produced.

Astatine was produced by the  $^{209}\text{Bi}(^3\text{He}, 3n)^{209}\text{At}$  reaction as described before. After the irradiation the bismuth target was dissolved in 5 ml of 1 N  $\text{HNO}_3$ , and then At was extracted with 5 ml of benzene, toluene and monochlorobenzene which were previously washed with acid. The astatine samples were contaminated with about 6 percents of  $^{210}\text{At}$ . The solutions which contained  $\text{At}_2$  were concentrated up to 100  $\mu\text{l}$  under reduced pressure at room temperature. The specific activity were about 0.5  $\mu\text{Ci}/\mu\text{l}$ .

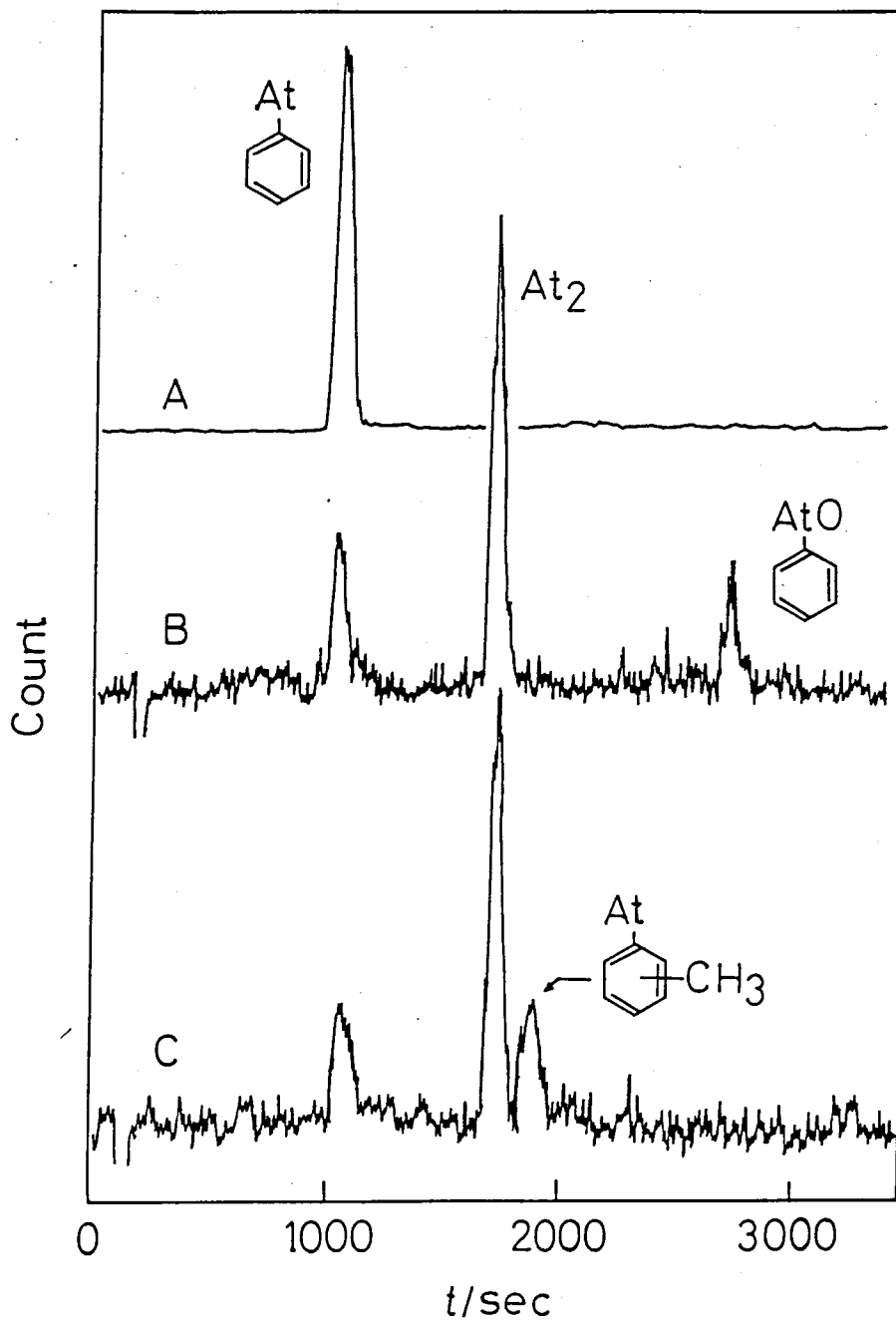

Fig. ii-1. Radiogaschromatograms of astatine compounds  
at 406 K

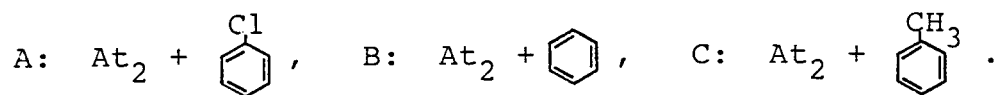

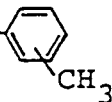

Table ii-1. Boiling points of astatine and astatine compounds

Compound	Boiling point (K)	
	obsd.	lit.
At <sub>2</sub>	503 ± 3	586 <sup>a)</sup>
At- 	484 ± 3	485 ± 2 <sup>b)</sup>
OAt- 	517 ± 3	-
At- 	505 ± 4	512 ± 4 <sup>c)</sup>

a) given in Ref. ii-16.

b) given in Ref. ii-17.

c) given in Ref. ii-18.

basis of the reasons that iodosobenzene analogous to astatosobenzene was observed in the reaction of carrier-free iodine-131 with benzene and no simple astatine compound having such a boiling point could be considered. For reference the radiogaschromatogram obtained for the sample of  $^{131}\text{I}_2$  plus benzene are shown in Fig. ii-2 and the boiling point of the peaks are listed in Table ii-2.

Now, it is reasonable to think that the reaction of carrier-free astatine with organic solvents is caused by the At-At bond cleavage by the decay of astatine from the following reasons:

- (1) Though other inactive elementary halogens generally don't react with benzene and toluene at ordinary temperature, only carrier-free species react with them when they are mixed.
- (2) Though in the thermal reaction the amounts of products depend on the temperature, in this case the amounts of them don't vary so much when the temperature is changed.
- (3) When carrier  $\text{I}_2$  was added in the  $\text{At}_2$  solution, the compounds of astatine with solvents were not produced in the present work. This may show that At-radicals produced in the solution are caught by  $\text{I}_2$  as radical collector.
- (4) The rate constants for the reactions, this is most important, are proportional to the half life of astatine used as described below.

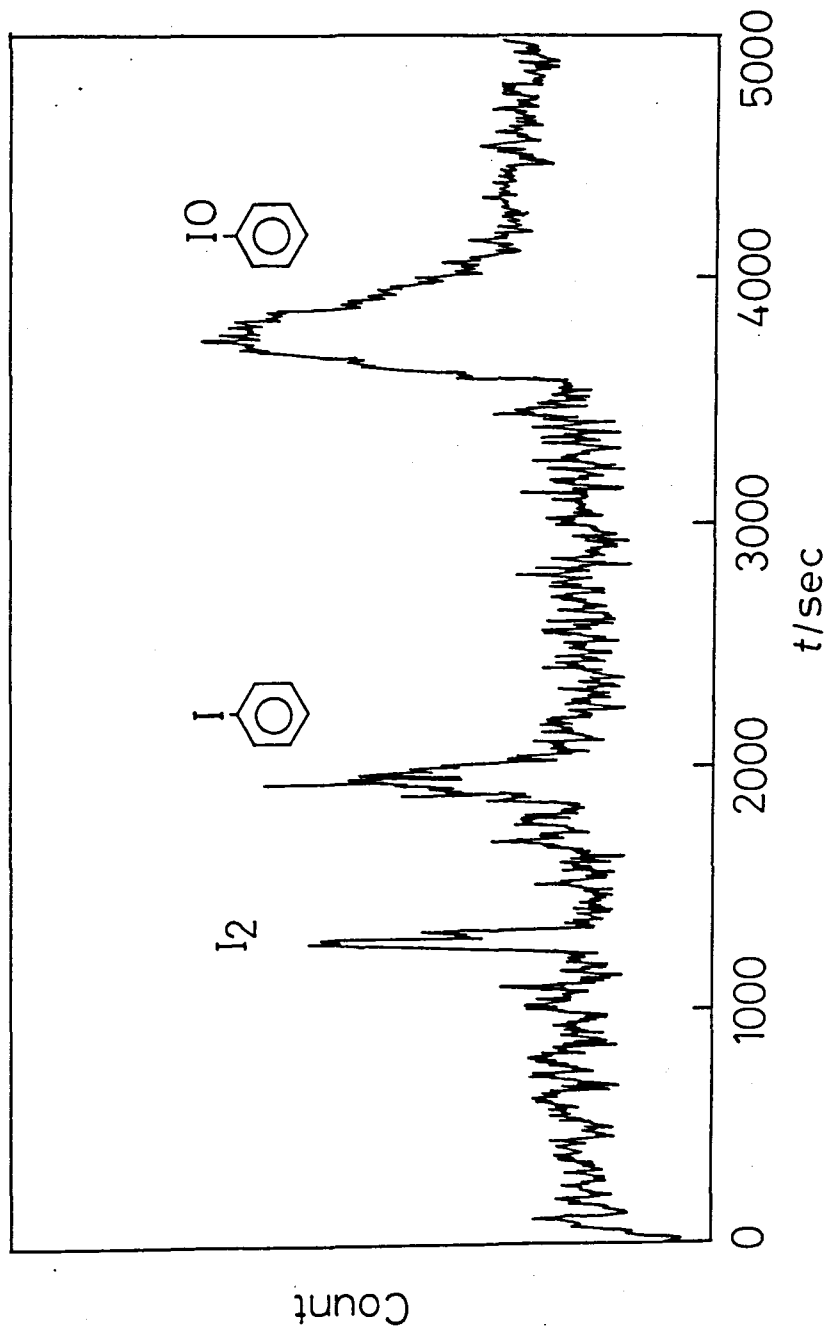



Fig. ii-2. Radiogaschromatogram of iodine compound at 377 K



Table ii-2. Boiling points of iodine and iodine compounds

Compound	Boiling point (K)		
	obsd.		lit.
I <sub>2</sub>	453	1	457.5 <sup>a)</sup>
I- 	462	2	463.6 <sup>a)</sup>
OI- 	483	3	483 <sup>a)</sup>

a) given in Ref. ii-16.

This reaction may be divided into 2 steps as follows:  
 Step 1; the bond of At-At is cleaved by the disintegration of either astatine in  $At_2$ , and the remained reacts with solvents.

Step 2; the compounds produced at step 1 is started to decompose by the decay of astatine.

As the number of molecule of the solvent is in large excess of  $At_2$  at step 1, the reaction depends only on the number of  $At_2$  molecules and is first-order for  $At_2$ . As the reaction is of a decomposition type in step 2, it depends only the number of At-compound and is first-order for At-compound. We assume here that these reactions proceed faster than thermal reactions. If the rate constants of steps 1 and 2 are  $k_{i1}$  and  $k_{i2}$ , respectively, the reaction is represented as

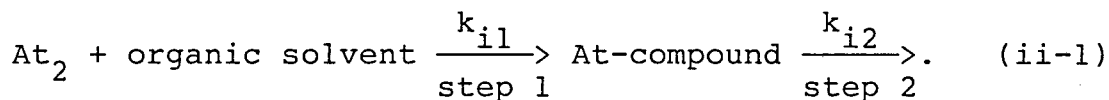

Here, subscript i indicates the kind of the compound produced in the same system, hence i takes 1 and 2 in the present work since two kinds of compounds are observed in both benzene and toluene systems. When the number of  $At_2$  molecule and At-compound in formula (ii-1) are  $N_{01}$  and  $N_{i2}$ , respectively, then

$$\frac{dN_{01}}{dt} = -2 \sum_i k_{i1} N_{01} \quad (\text{ii-2})$$

and

$$\frac{dN_{i2}}{dt} = 2k_{i1} N_{01} - k_{i2} N_{i2} \quad (\text{ii-3})$$

hold. If the activity of  $At_2$  and the compound are  $A_{01}$  and  $A_{i2}$ , respectively, the following equations are obtained:

$$A_{01} = 2\lambda N_{01}^0 = 2\lambda N_{01}^0 \exp(-2 \sum_i k_{i1} t), \quad (\text{ii-4})$$

$$A_{i2} = \lambda N_{i2} = \frac{2k_{i1}}{k_{i2} - k_{i2}} \lambda N_{01}^0 \{ \exp(-2 \sum_i k_{i1} t) - \exp(k_{i2} t) \}. \quad (\text{ii-5})$$

Here,  $N_{01}^0$  is the number of  $At_2$  molecule at  $t = 0$  and  $\lambda$  is the decay constant of astatine used. The activity ratio is represented as

$$\frac{A_{i2}}{A_{01}} = \frac{k_{i1}}{k_{i2} - 2\int_i k_{i1}} \{1 - \exp(-k_{i2}t + 2\int_i k_{i1}t)\}. \quad (\text{ii-6})$$

The curve of  $A_{i2}/A_{01}$  vs. time was analyzed by the analogous method to the analysis of decay curve, and  $k_{i1}$  and  $k_{i2}$  were calculated. The time-courses of  $A_{i2}/A_{01}$  for  $\text{At}_2$  plus benzene and toluene are shown in Figs. ii-3 and ii-4, respectively. The analysis for  $\text{At}_2$  plus monochlorobenzene was not carried out, because  $\text{At}_2$  couldn't be observed in the present work as shown in Fig. ii-1 and subsequently the activity ratio couldn't be obtained. In Table ii-3  $k_{i1}$  and  $k_{i2}$  (divided by  $\lambda$  for convenience of discussion) obtained by the analysis for benzene and toluene systems are listed. All values of  $k_{11}/\lambda$  and  $k_{21}/\lambda$  are nearly constant and  $k_{11}/\lambda$  plus  $k_{21}/\lambda$  equals to unit for both benzene and toluene systems. This shows that the reaction can occur only when the bond of  $\text{At}-\text{At}$  is cleaved by the disintegration of either astatine in  $\text{At}_2$  as assumed above and the remained astatine reacts immediately with surrounding solvents. Further, the reaction at step 2 may be caused by the disintegration of astatine too because  $k_{i2}/\lambda$  is almost constant.

In the reaction of  $\text{At}_2$  plus monochlorobenzene system  $\text{At}_2$  may react too rapidly to be observed. If this mechanism is accepted,  $k_{i1}/\lambda$  and  $k_{i2}/\lambda$  should have very large values.

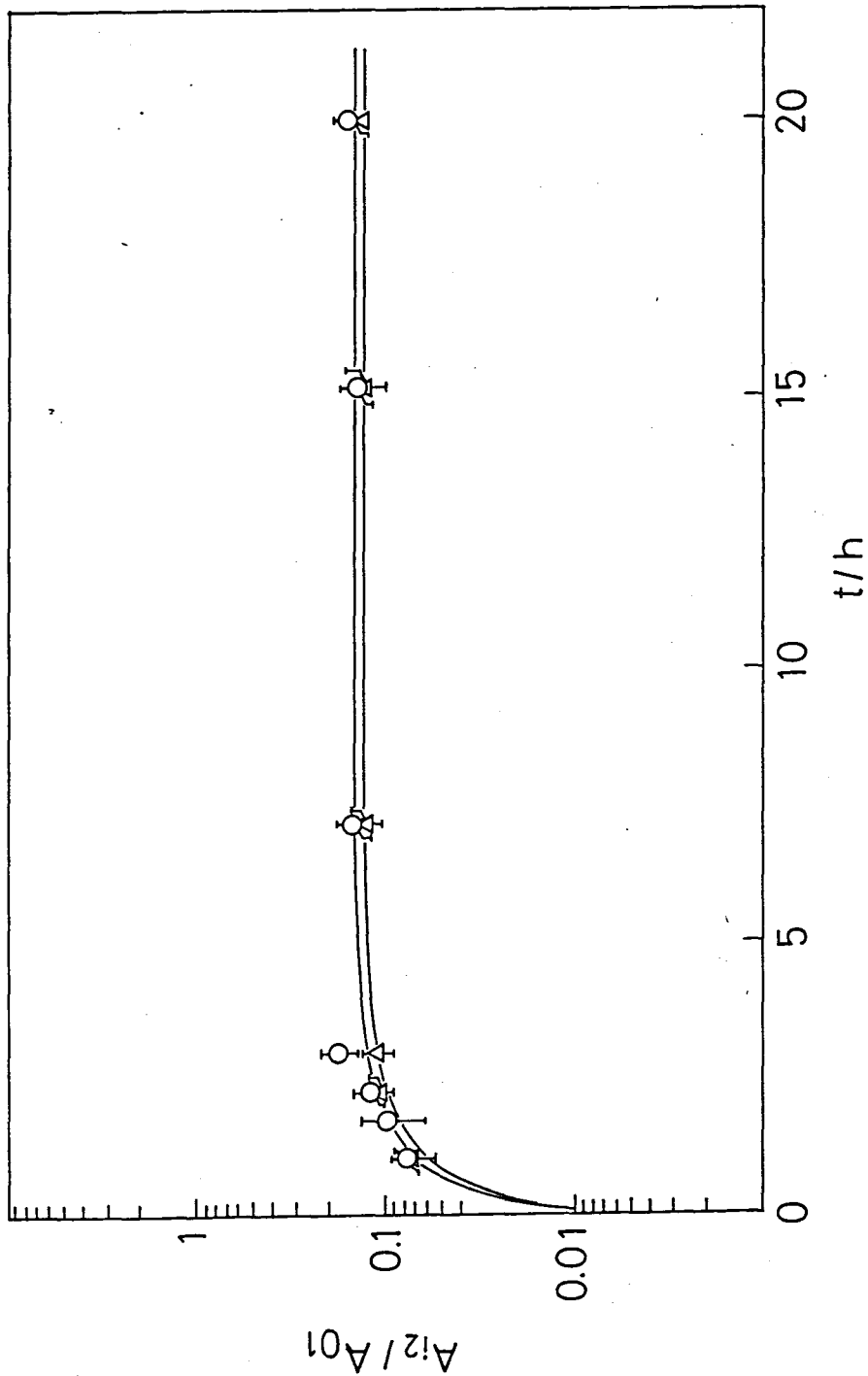

Fig. ii-3. Time-courses of activity ratio in benzene system



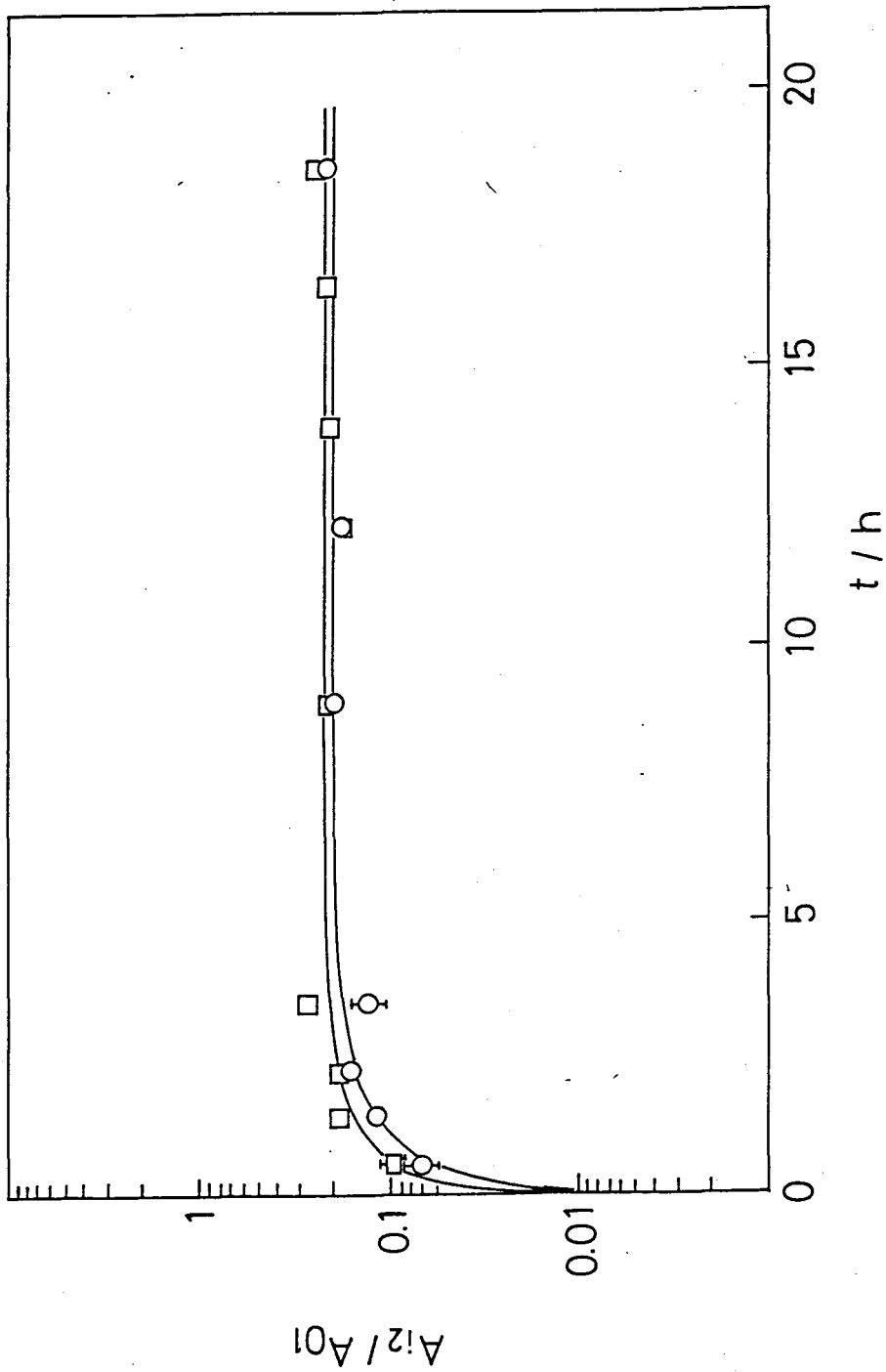





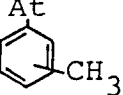

Fig. ii-4. Time-courses of activity ratio in toluene system



Table ii-3. Rate constants for the reaction of astatine with benzene and toluene

Reaction	i	compd.	$k_{i1}/\lambda$	$k_{i2}/\lambda$
$\text{At}_2 + $ 	1		$0.5 \pm 0.2$	$5.2 \pm 1.8$
	2		$0.4 \pm 0.2$	$5.2 \pm 1.8$
$\text{At}_2 + $ 	1		$0.6 \pm 0.2$	$6.0 \pm 2.0$
	2		$0.7 \pm 0.3$	$6.2 \pm 2.1$

In  $^{131}\text{I}_2$  plus benzene system the sum of  $k_{i1}/\lambda$  and  $k_{i2}/\lambda$  are larger than unit. This implies that in these reactions the ordinary chemical reaction may occur with high speed too.



APPENDIX (iii)

DETERMINATION OF THE MOLECULAR WEIGHT AND SOLUBILITY  
PARAMETERS OF HIGH-POLYMERS BY GAS CHROMATOGRAPHY[iii-1]

Since the formulae in the reference [iii-2] are cited so frequently, they are expressed in abbreviated forms as below.

$$\ln V_R = \ln N - \mu \epsilon + v + c \quad (\text{iii-1})$$

with

$$\mu(T_b, T) = Z \{ (1 + h)rT_b/T - (1 + hr) \}, \quad (\text{iii-2})$$

$$v(T_b, T) = r(T_b/T - 1), \quad (\text{iii-3})$$

and

$$c(T_b, T) = \ln ZRT\theta. \quad (\text{iii-4})$$

If the retention volume of a halogen for the solvent of the sample polymer is measured at two column temperatures of  $T_1$  and  $T_2$ , the formulae

$$\ln V_{R1} = \ln N - \mu_1 \epsilon + v_1 + c_1 \quad (\text{iii-5})$$

and

$$\ln V_{R2} = \ln N - \mu_2 \epsilon + v_2 + c_2 \quad (\text{iii-6})$$

are obtained. Here, the subscripts 1 and 2 correspond to  $T_1$  and  $T_2$ , respectively. In formulae (iii-5) and (iii-6)  $V_R$  can be experimentally obtained, and  $\mu$ ,  $v$  and  $c$  are easily calculated with formulae (iii-2), (iii-3) and (iii-4) for given values of  $T_b$  and  $T$ . Thus, unknown  $N$  and  $\epsilon$  can be calculated from the two simultaneous equations.

From  $N$  the average molecular weight  $M_w$  of the solvent is calculated by  $M_w = W/N$ , where  $W$  is the weight of sample used. From  $\epsilon$  the solubility parameter  $\delta_s$  of the solvent is calculated.

For iodine solute ( $T_b = 457$  K) at two column temperatures  $T_1 = 353$  K and  $T_2 = 403$  K, for example, simultaneous equations (iii-5) and (iii-6) become

$$\ln V_{R1} = \ln N - 15.67\epsilon + 18.64 \quad (\text{iii-7})$$

and

$$\ln V_{R2} = \ln N - 12.54\epsilon + 16.57. \quad (\text{iii-8})$$

The quantity  $M_w$  is determined easily by  $M_w = W/N$  as mentioned above, and  $\delta_s$  is obtained by

$$\delta_s = 8.462\epsilon^{1/2} + 6.599, \quad (\text{iii-9})$$

which is derived from Eqs. (i-6) and (i-7) using  $T_b = 457$  K,  $\bar{\delta} = 7.333$ , which is derived from Eq. (i-6) with  $\bar{T}_b = 349$  K given in reference [iii-3].

For three kinds of Silicon Oil DC and PEG, which are the most popular solvents for gas chromatography, the values of  $M_w$  and  $\delta_s$  are listed in Tables (iii-1) and (iii-2), respectively.

Table iii-1. Molecular weights of silicon oil  
and PEG

Sample	$M_w$			
	This method		Usual method	lit. <sup>a)</sup>
	$I_2$	$Br_2$		
Silicon DC 550	50000	50000	50000 <sup>b)</sup>	
702	62300	62500	62500 <sup>b)</sup>	
710	89200	89300	89300 <sup>b)</sup>	
PEG 1500	1500	1500	1500 <sup>c)</sup>	1500
4000	3100	3050	3100 <sup>c)</sup>	3000-3700
6000	6750	6760	6750 <sup>c)</sup>	6000-7500

a) Stecker[iii-3].

b) Osmotic method.

c) Vapour pressure method.

Table iii-2. Solubility parameters of silicon oil and PEG

Sample	$\delta_s$		lit. a)
	This method		
	I <sub>2</sub>	Br <sub>2</sub>	
Silicon DC 550	8.1	8.1	
702	8.0	8.0	
710	7.9	7.9	
PEG 1500	11.7	11.7	
4000	11.6	11.6	8.9-12.7 <sup>b)</sup> 8.5-14.7 <sup>c)</sup> 9.5-14.5 <sup>d)</sup>
6000	11.6	11.6	

a) Brandrap and Immergut[iii-1].

b), c) and d) For poorly, moderately and strongly hydrogen bonded solvents, respectively.

References for Appendix (i)

- i-1. K. Otozai, Z. Anal. Chem. 268, 257 (1974).
- i-2. G. Samson and A. H. W. Aten Jr., Radiochim. Acta 12, 55 (1969).
- i-3. G. Samson and A. H. W. Aten Jr., Radiochim. Acta 13, 220 (1970).
- i-4. G. J. Meyer, K. Rossler and G. Stocklin, Radiochem. Radioanal. Lett. 21, 247 (1975).
- i-5. G. J. Meyer, K. Rossler and G. Stocklin, Radiochim. Acta 24, 81 (1977).
- i-6. E. J. Knust and M. Schuller, J. Chromatogr. 114, 207 (1975).
- i-7. P. E. Porter, C. H. Deal and F. H. Stross, J. Am. Chem. Soc. 78, 2999 (1956).
- i-8. J. H. Hildebrand and R. L. Scott, Regular Solutions, Prentice Hall Inc., New Jersey (1962).
- i-9. J. H. Hildebrand and R. L. Scott, Solubility of Non-Electrolytes; 3d edit., Dover Publ., New York (1964).
- i-10. D. R. Stull, Ind. Eng. Chem. 39, 515 (1947).

i-11. D. R. Stull, Ind. Eng. Chem. 39, 540 (1947).

References for Appendix (ii)

- ii-1. N. Takahashi and K. Otozai, to be published.
- ii-2. A. H. W. Aten Jr., Adv. Inorg. Chem. Radiochem. 6, 207 (1964).
- ii-3. H. M. Neumann, J. Inorg. Nucl. Chem. 4, 349 (1957).
- ii-4. E. H. Appelman, E. N. Sloth and M. H. Studier, Inorg. Chem. 5, 766 (1966).
- ii-5. J. E. Willard, Ann. Rev. Nucl. Sci. 3, 193 (1953).
- ii-6. G. Harbottle, Ann. Rev. Nucl. Sci. 15, 89 (1965).
- ii-7. M. Halman, Chem. Rev. 64, 689 (1963).
- ii-8. T. A. Carlson and R. M. White, Chemical Effects of Nuclear Transitions; vol I, I. A. E. A., Vienna (1961).
- ii-9. H. J. Machulla, P. Laufa and G. Stocklin, J. Radioanal. Chem. 32, 381 (1976).
- ii-10. J. A. Cramer and F. S. Rowland, J. Am. Chem. Soc. 96, 6579 (1974).
- ii-11. L. Vasaros, Yu. V. Norseyev, G. J. Meyer, K. Berei and V. A. Kahlkin, Radiochim. Acta 26, 171 (1979).

References for Appendix (iii)

- iii-1. I. Tohyama and K. Otozai, Z. Anal. Chem. 281, 131 (1976).
- iii-2. K. Otozai, Z. Anal. Chem. 268, 257 (1974).
- iii-3. K. Otozai and I. Tohyama, Z. Anal. Chem. 279, 195 (1976).



LIST OF PUBLICATION

Nagao Ikeda and Naruto Takahashi

NEUTRON ACTIVATION ANALYSIS OF THE RARE EARTH  
ELEMENTS IN NASU HOT SPRINGS  
Radioisotopes 27, 299 (1978)

T. Nishi, I. Fujiwara, N. Imanishi, H. Moriyama,  
K. Otozai, R. Arakawa, T. Saito, T. Tsuneyoshi,  
N. Takahashi, S. Iwata, S. Hayashi, S. Shibata,  
H. Kudo and K. Yoshida

CROSS SECTION OF NEGATIVE-PION-INDUCED REACTIONS IN  $^9\text{Be}$   
 $^{12}\text{C}$  AND  $^{19}\text{F}$  NUCLEI BETWEEN 0.4 AND 1.9 GeV  
Nuclear Physics A352, 461 (1981)

Tomota Nishi, Ichiro Fujiwara, Nobutsugu Imanishi,  
Hirotake Moriyama, Kiyoteru Otozai, Ryuichi Arakawa,  
Tadashi Saito, Toshihiro Tsuneyoshi, Naruto Takahashi,  
Shiro Iwata, Shigeki Hayashi, Seiichi Shibata, Hisaaki Kudo  
and Kunio Yoshida

NEGATIVE PION INDUCED REACTIONS IN BISMUTH AT 0.87 GeV  
Bulletin of the Institute for Chemical Research,  
Kyoto University 60, 132 (1982)

K. Otozai and N. Takahashi

ESTIMATION OF THE CHEMICAL FORM AND THE BOILING POINT  
OF ELEMENTARY ASTATINE BY RADIOGASCHROMATOGRAPHY

Radiochimica Acta (in press)

Naruto Takahashi and Kiyoteru Otozai

ESTIMATION OF BOILING POINT OF RADON  
BY RADIOGASCHROMATOGRAPHY

submitted to Nature

Naruto Takahashi and Kiyoteru Otozai

REACTION MECHANISMS OF ELEMENTARY ASTATINE WITH  
SOME ORGANIC SOLVENTS

to be published