

Title	DESIGN OF GAMMA-RAY STANDARD FIELD AND STUDIES ON ENVIRONMENTAL TRITIUM MEASUREMENT
Author(s)	Yamaguchi, Yoshiaki
Citation	大阪大学, 1998, 博士論文
Version Type	VoR
URL	https://doi.org/10.11501/3144227
rights	
Note	

Osaka University Knowledge Archive : OUKA

<https://ir.library.osaka-u.ac.jp/>

Osaka University

27474

DESIGN OF GAMMA-RAY STANDARD FIELD
AND
STUDIES ON ENVIRONMENTAL TRITIUM MEASUREMENT

BY
YOSHIAKI YAMAGUCHI

1998

11
2
25

DESIGN OF GAMMA-RAY STANDARD FIELD
AND
STUDIES ON ENVIRONMENTAL TRITIUM MEASUREMENT

BY

YOSHIAKI YAMAGUCHI

A THESIS
SUBMITTED TO
GRADUATE SCHOOL OF SCIENCE
OSAKA UNIVERSITY

1998

Preface

The works in this thesis were carried out under the guidance of Professor Hiroshi Baba at Graduate School of Science, Osaka University.

The object of this thesis is to design the standard irradiation field using γ -ray sources and develop a method for environmental tritium measurement.

Radioisotope Research Center,
Osaka University,
Yamada-Oka, Suita,
Osaka 565-0171
Japan

Yoshiaki Yamaguchi

Contents

General Introduction	1
Chapter I Construction of the Standard γ -ray Irradiation Field	
I -1 Introduction	5
I -2 An Automatically Controlled Field Size of a γ -ray Irradiation System	
I -2-1 Outline of the System and its Modification	8
I -2-2 Estimation of the Ability to Radiation Shield	15
I -2-3 Summary	18
I -3 Estimation of the Scattered Radiation in the Calibration Field Generated by the γ -ray Irradiation System	
I -3-1 Characterization of the Irradiation Field	19
I -3-2 Results and discussion	26
I -4 Utilization of the Standard Field	
I -4-1 Calibration of the Survey Meters	27
I -4-2 Calibration of the Personal External Exposure Monitors	31
I -4-3 Irradiation on Mice	35
I -4-4 Summary	36
References to Chapter I	37

Chapter II	Pre-treatment of Environmental Samples for Tritium Concentration Measurements	
II-1	Environment Tritium and the Liquid Scintillation Counting System	
II-1-1	Environmental Tritium	38
II-1-2	Liquid Scintillation Counting System	42
II-2	Pre-treatment of Samples by the Reduced-Pressure Distillation System	
II-2-1	Design of the Reduced-Pressure Distillation System	48
II-2-2	Outline of the System	50
II-2-3	Experimental	52
II-2-4	Results and Discussion	54
II-3	Pre-treatment of the Samples by the Microwave Heating Distillation System	
II-3-1	Design of the Microwave-Heating Distillation System	80
II-3-2	Outline of the System	83
II-3-3	Condition of Microwave-Heating Distillation	85
II-3-4	Results and Discussion	90
	References to Chapter II	96
	Conclusion	98
	List of Publications	101
	Acknowledgments	102

General Introduction

The environmental deterioration in narrow areas due to the noise, vibration, stench, ground pollution, ground sinking and so on became a serious social problem increasingly in the 1960s. In Japan, regulation standards were set for the factory and the business place in order to solve this problem. A remarkable consequence has been obtained by the elimination of the occurrence sources according to this regulation. Accordingly, living environment in the circumference area is considerably improved. It is said that Japan is situated at an advanced level in the world concerning the pollution prevention technique.

However, the environmental problem in wide areas emerged in later years. For example, the atmospheric pollution was accompanied with the increasing volume of traffic while the water pollution became serious in the inland sea or lake. A number of problems are left unsolved to keep healthy living environment.

Moreover, the world wide problems have begun to be recognized in concordance with the consumptive increase or expansion of consumption of the energy. They are the global warming, acid rain, ozone-layer destruction, forest disappearance, radioactivity pollution and so on. The environmental problems are complicatedly related with one another and have the influence on the earth scale. These many problems must be therefore considered on the earth scale. The atmospheric temperature of the earth surface rises and the global warming is progressing due to the increase of burning gas such as methane. Soot, sulfur oxide (SO_x),

nitrogen oxide (NO_x) and so on are caused by the burning of fossil fuel and have a serious influence on the creature. They dissolve in water vapor in the atmosphere and provide acid rain to the creature. The ozone layer in the stratosphere is known to be destroyed by the fluorine gas, etc. liberated on the earth. Once the ozone layer is destroyed, the ultraviolet light reaches intensively the surface of the earth and hence a human body is affected by the skin cancer. Forests, particularly tropical rain woods, are decreasing year by year as the important source of the timber and the pulp. Slash-and-burn farming further accelerates the disappearance of the forest in addition to the reckless felling of woods.

Radioactive pollution casts another aspect of environmental problems. The use of the atomic energy emerged in the middle of the 20th century. The environmental pollution by the man-made sources of radioactivity became serious as the use of the atomic energy. The nuclear tests in the atmosphere and accidents at the nuclear reactors distributed a lot of man-made sources of radioactivity all over the world. 10 years or more have passed since the last nuclear test in the atmosphere or the last nuclear reactor accident, but a part of the man-made radioactivity continues to exist in the environment. The radioactivities pollute the environment for a long time and give a bad influence on the animals and plants. ³H, ¹³⁷Cs and ⁹⁰Sr are typically occurring radioactivities diffusing over wide areas. As a result of the nuclear test in the stratosphere, radioactivities diffused on the earth scale. In addition, radioactivities may also be released from the nuclear research facilities. Thus the various radioactivities exist widely in air,

plants, soil, water, human bodies and other substances.

The purpose of the environmental radioactivity measurement is to watch over the radiation hazard to the human body, fallout resting from the nuclear test and the environment pollution around the nuclear facilities and so forth. The radioactivities released to the environment are taken in the human being via various processes. Radioactivities diffuse to the environment of the atmosphere, water and soil, and then absorbed by the human with air, water and via the crops and the animal. There are various objects which are useful for grasping of accumulation in the environment and estimating the exposure. Concretely, the measurement of the environmental radioactivity is done using samples like the atmosphere, land water, land soil, bottom soil of the sea and lake, drainage, food, marine samples, index creatures, etc.. Some of them can be directly measured without any pre-treatment, while the rest require some pre-treatments prior to measurement. As for soil and the index creatures, it is necessary to separate moisture and solid by distillation. This is quite time consuming and gives difficulty for handling a huge number of samples in the environmental monitoring.

In the case where any radiation hazard has taken place an urgent response is required to the environmental monitoring. Therefore, it is strongly desired that the sample pre-treatment is simplified and the time required for the pre-treatment is shortened. The environmental radioactivities are measured with activity monitoring devices calibrated beforehand. Calibration of the detectors are generally carried out using primary standard sources supplied by manufacturers. In the

radiation control section of nuclear reactors or other facilities handling radioactivities, one must meet radiations of a wide dynamic range from environmental activities to very high radiation dose. Calibration of detectors with different operation ranges requires to complete standard sources with various strengths and the procedure of calibration necessarily differs for one another. Therefore, the construction of a standard irradiation field is quite desirable for unifying and simplifying the detection calibration procedure.

The present work is concerned with the construction of a standard irradiation field and development of a new procedure of sample pre-treatment. Chapter I describes the construction of a standard irradiation field consisting of a γ - ray irradiation system. A commercial γ -ray irradiation system was combined with irradiation field controlling device designed for the present purpose (Chapter I -2). The scattered radiation dose was estimated for the constructed facility by calculation to determine the irradiation field strength at a given position accurately (Chapter I -3). As examples of the usage, the results of detector calibration and an irradiation experiment are presented (Chapter I -4).

Chapter II is concerned with the pre-treatment of the environmental samples for dose rate measurement. An inexpensive distillation system for pre-treatment was constructed using a commercial equipment incorporated with microwave heating function (Chapter II -2). With the new device, the processing time was significantly reduced compared to that of the conventional method. The processing time is now as short as tens of minutes (Chapter II -3).

Chapter I Construction of the Standard γ -ray Irradiation Field

I-1 Introduction

Recently, many studies are focused on internal exposure of β -rays in small animals to which tritium water (HTO) is injected. The dose rate of β -rays decreases with time as HTO is expelled from the body according to the biological half-life. For the investigation of biological effect of HTO, the time-dependent dose rate can be simulated by external exposure of γ -rays. In order to undertake such a study quantitatively, construction of a standard γ -ray irradiation field is inevitable. From the view point of radiation control, such a system is also required for calibrating radiation monitors such as personnel dosimeters and survey meters.^{1,2)} Because the system and its irradiation field are specifically designed for medical studies, using the system for calibration under special conditions requires evaluation of the irradiation field, especially the effect of scattered radiation. For this purpose, a γ -ray irradiation system was installed in the Radioisotope Research Center of Osaka University. The irradiation system is the same type as the one installed in the Research Institute for Nuclear Medicine and Biology of Hiroshima University in 1987.³⁾

Prior to the installation of the system to the Radioisotope Research Center, the first consideration given from the view point of radiation control was to satisfy the dose equivalent limit defined by the "The Law Concerning Prevention from Radiation Hazards due to Radioisotopes, Etc." for the radiation facility. Because the adopted irradiation

system is capable of storing a sealed source of ^{137}Cs up to an activity of 1110GBq, there will be no problems regarding radiation shielding of a 111GBq ^{137}Cs source planned to be used at the facility. However, when a source is out of the shield, i.e. during irradiation, additional means are required to suppress the radiation dose at the boundary of the radiation controlled area to less than the dose equivalent limit defined by the law. Because the irradiation room was not originally designed for installing an irradiation equipment, the wall thickness of the room was not designed to provide sufficient shielding. Ordinary methods to enhance the shielding power of the entire walls with heavy materials, such as concrete or lead, was found to be structurally impracticable. Therefore we decided to modify the system by adding a device automatically controlling the irradiation field size and thus reducing the weight of shield substantially. The design and the results of this modification are presented in the succeeding subsection.

In order to use the irradiation field of the modified system for calibration of monitor counters and dosimeters, the field strength around the irradiation field should be thoroughly evaluated. By establishing an irradiation field for calibration and by keeping traceability to the data of Electrotechnical Laboratory, the national agency for radiation standards, we were able to calibrate and maintain the precision of the dosimeters used for radiation control in Osaka University.

Furthermore, the contribution of the scattered radiation to the irradiation field was evaluated by means of radiation measurement and

calculation. A generic radiation transport code (MCNP) ⁴⁾ was used for the numerical analysis. Since MCNP allows three-dimensional modeling of the irradiation room, the angular and energy distributions of scattered radiation could be calculated. Because of popularization of computers in recent years, use of this type of the generic radiation transport code for evaluating irradiation fields is becoming popular in radiation control and radiation effect assessment. A report using MCNP for irradiation field analysis is already available. ⁵⁾

I -2 An Automatically Controlled Field Size of a γ -ray Irradiation System

I -2-1 Outline of the System and its Modification

The original model, to which modification was made, is the ^{137}Cs γ -ray irradiation system Model SK-951 of Sangyo Kagaku Co. Ltd.,. It can contain three ^{137}Cs sources of different intensities: 1110, 111, and 11.1GBq. The dose rate is continuously changeable through a wide range by adjusting the distance between the source and the exposed sample and changing the equipped sources. The distance between the fixed source and the rail-guided mobile exposure deck, on which an experimental animal cage is to be loaded, can be controlled by a computer for a range of 0.7–4.5m. The contribution of the radiation leaking from encapsulated 1110 and 111GBq sources were suppressed to less than 0.1% during a low-dose exposure by using a 11.1GBq ^{137}Cs source. The excellent shielding of stored sources was attained due to the geometrical separation of the source container and the irradiation aperture. The Hiroshima University's irradiation system is equipped with a 1110GBq ^{137}Cs source, while the one installed in Osaka University contains a 3.7GBq ^{60}Co source besides 111GBq and 11.1GBq ^{137}Cs sources instead of a 1110GBq source in order to meet various types of application besides biological irradiation are planned.

The room where the system is installed has a floor area of 4.8m \times 6.9m. The concrete wall thickness is 30cm, the entrance door which is a first-class fire-proof door contains 3cm-thick lead plate.

The outer surface of the concrete wall is the boundary of the controlled area. The 1cm dose equivalent on the surfaces should, therefore, not exceed $300 \mu\text{ Sv}$ per week. If a $1110\text{GBq }^{137}\text{Cs}$ source were used in this room, the 1cm dose equivalent at the controlled area boundary would become about 45mSv per week. It is about 150 times the dose equivalent limit. In the calculation, the distance from the source to the boundary was taken to be 5m and one week was taken to be fully 168 hours. Even in the case of a $111\text{GBq }^{137}\text{Cs}$ source, the dose equivalent was estimated to be 15 times the limit. The thickness of the lead shield required to suppress the dose equivalent to $300 \mu\text{ Sv}$ or less, was calculated to be about 5cm for a 1110GBq source or 3cm for a 111GBq source. The weight of resulting shield to cover the one side of the wall would be 7 or 4 ton, which would not be sustained by the building. A solution for the difficulty was found by setting a mobile shield directly on the rear the exposure deck as shown in Photo. I -1. The shield has an area of $1200\text{mm} \times 1200\text{mm}$ and widths of 30mm (lead) + 20mm (iron). This mobile shield enabled the use of a $111\text{GBq }^{137}\text{Cs}$ source.

Lead collimators with different aperture angles were designed and installed in the irradiator to restrain the irradiation field within the area of the mobile shield. The distance between the source and the exposure deck is occasionally changed, but the maximum available exposure area can be secured by switching collimators. A collimator is automatically selected according to the distance between the source and the deck so that the irradiation field is restrained within the area of the shield. As shown in Table I -1, the collimator with aperture

angles of 20.02, 9.27, or 6.03 degrees is respectively selected when the distance is less than 2m, 2-3m, or more than 3m. The three collimators are installed in the irradiator in a ring pattern as shown in Photo. I - 2, so that they compactly fit in the irradiator. The collimator part, which has a total weight of about 280kg, smoothly rotates about the source thus ensuring mechanical stability and reliability.

The field size is normally confirmed visually by replacing a source with a halogen lamp. To provide further confirmation, GM counters are installed at the four corners of the mobile shield. When a GM counter records a counting rate that exceeds the specified threshold, the field is judged to be not contained within the shield area and the source is automatically encapsulated in the source container. The appearance and the main specifications of the Osaka University's irradiation system are shown in Fig. I -1 and Table I -1, respectively. By installing the lead collimators and the mobile lead shield, the radiation dose at the controlled area boundary could be suppressed to less than the dose equivalent limit.

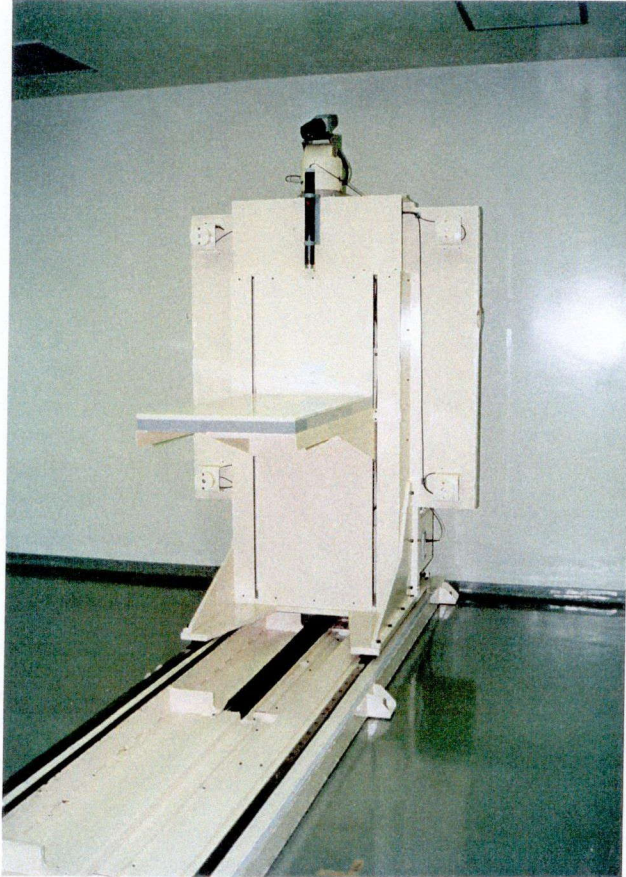

Photo.1-1 A mobile exposure deck (table and shield)
of an irradiation system



Photo.1-2 An irradiator of an irradiation system

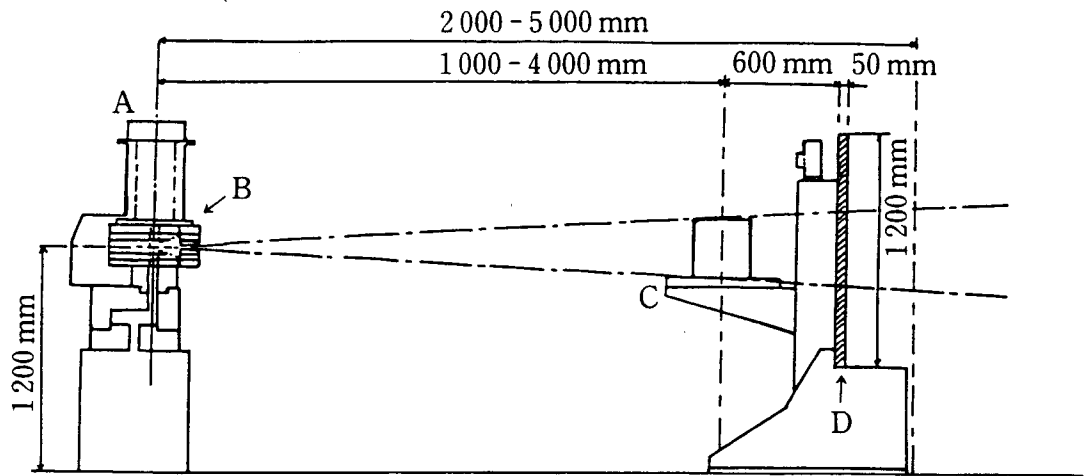

Fig.1-1 A side view of an irradiation system
 A:Irradiator B:Collimator C:Table D:Shield

Table 1-1 Characteristics of an irradiation system at HANDAI type

Source	$^{60}\text{Co}(3.7\text{GBq})^*$ $^{137}\text{Cs}(11.1\text{GBq})^*$ *not calibrated $^{137}\text{Cs}(111\text{GBq})^*$			
Dose-equivalent rate		$^{60}\text{Co}(3.7\text{GBq})$	$^{137}\text{Cs}(11.1\text{GBq})$	$^{137}\text{Cs}(111\text{GBq})$
	100cm	1.28 mSv/h	1.07 mSv/h	10.69 mSv/h
	400cm	80.24 $\mu\text{Sv/h}$	66.81 $\mu\text{Sv/h}$	668.08 $\mu\text{Sv/h}$
Collimator	Angle	20.02°	9.27°	6.03°
	Distance	1~2m	2~3m	3~4m
Mobile car	Distance 100~400cm(distance between source and table) Error $\pm 1\text{mm}$ Speed 1.00~5.00mm/sec at high speed 0.01~0.05mm/sec at slow speed Table 600mm(W) \times 600mm(D) Shield 1,200mm(W) \times 1,200mm(H) \times 50mm(D)** **(Pb30mm+Fe20mm)			
Source container	500 ϕ (Pb 110mm) \times 320mm(H)			
Field size	Minimum 300mm(W) \times 300mm(H)			
Operation mode	Manual operation mode Timer operation mode Program operation mode (Simulating irradiation)			
Safety device	Back up power supply for power failure Manual safe keeping hundle for emergency Automatic interlocking device Monitoring by TV camera Checking of field size with Geiger-Mueller counter			

I-2-2 Estimation of the Ability to Radiation Shield

The Osaka University's irradiation system contains three types of radiation sources; 3.7GBq ^{60}Co , 11.1GBq ^{137}Cs , and 111GBq ^{137}Cs sources. For these sources, the 1cm dose equivalent at the controlled area boundary can be calculated by:

$$H_{1\text{cm}} = 0.0963 \times A \times T \times D t \times r^{-2} \times 10^3 \quad (\text{I} - 1) \text{ 6)}$$

where

$H_{1\text{cm}}$: 1cm dose equivalent (μ Sv/week),

0963 : 1cm dose- equivalent rate constant ($\text{mSv} \cdot \text{m}^2 \cdot \text{GBq}^{-1} \cdot \text{h}^{-1}$) for ^{137}Cs (0.347 in the case of ^{60}Co),⁷⁾

r : distance from the source(m),

A : amount of radioisotope (GBq),

Dt : attenuation factor of 1cm dose equivalent for a shield with a thickness of t cm(if there are multiple shields, the product of the attenuation factors of all shields),

T : operating hours in a week.

Equation I -1 provides the maximum value of 1cm dose equivalent at the controlled area boundary when a 3.7GBq ^{60}Co source is used for irradiation and the other two sources are encapsulated. The 1cm dose equivalent by ^{60}Co source was 156.24 μ Sv per week. The contribution

of the other two sources is calculable by considering the attenuation effect of the source container, which has 11cm-thick lead walls. The result is given in Table I -2. The total dose equivalent at the controlled area boundary was evaluated to be 156.3 μ Sv per week, which is less than the legal dose equivalent limit of 300 μ Sv per week. ^{60}Co has a relatively short half-life of 5.27 years, and its radioactivity becomes about 75% of the original value after two years. Under this condition, the maximum value of 1cm dose equivalent was obtained when a 111GBq ^{137}Cs source was used for irradiation and the other two sources are encapsulated. The total dose equivalent at the controlled area boundary was about 115 μ Sv per week in this case.

Table 1-2 Dose-equivalent of controlled area

In house at $^{137}\text{Cs}(111\text{GBq})$					
Shield	: Pb 110mm,	Pb 30mm,	Fe 10mm,	Fe 10mm,	Concrete 300mm
Attenuation rate	: 5.6×10^{-6} ,	4.5×10^{-2} ,	7.8×10^{-1} ,	7.8×10^{-1} ,	6.2×10^{-2}
Distance	: 5.0 m				
Irradiation time	: 168 h				
Dose-equivalent	: 6.83×10^{-4}				μSv

In house at $^{137}\text{Cs}(11.1\text{GBq})$					
Shield	: Pb 110mm,	Pb 30mm,	Fe 10mm,	Fe 10mm,	Concrete 300mm
Attenuation rate	: 5.6×10^{-6} ,	4.5×10^{-2} ,	7.8×10^{-1} ,	7.8×10^{-1} ,	6.2×10^{-2}
Distance	: 5.0 m				
Irradiation time	: 168 h				
Dose-equivalent	: 6.83×10^{-5}				μSv

In irradiation at $^{60}\text{Co}(3.7\text{GBq})$					
Shield	: Pb 30mm,	Fe 10mm,	Fe 10mm,	Concrete 300mm	
Attenuation rate	: 2.3×10^{-1} ,	8.1×10^{-1} ,	8.1×10^{-1} ,	1.2×10^{-1}	
Distance	: 5.0 m				
Irradiation time	: 168 h				
Dose-equivalent	: 156.24				μSv

Total dose-equivalent : 156.3 μSv

I -2-3 Summary

Technical modification of a commercial γ -ray irradiation system was described in Section I -2. Introduction of a mobile shield and collimators restraining the field within the shield area and automatic control of the field size allowed the irradiation system to be installed in the workroom without heavy shield.⁸⁾ The weight of the irradiation system was reduced to about 700kg light enough to be installed in an ordinary hot laboratory. It is even possible to change a cold laboratory to a hot laboratory and install the irradiation system, if necessary requirements are cleared.

We plan to use this modified γ -ray irradiation system for simulating animal's internal exposure to β -ray and also for calibrating generic γ -ray dosimeters, especially those used for radiation control.

I -3 Estimation of the Scattered Radiation in the Calibration Field Generated by the γ -ray Irradiation System

I -3 -1 Characterization of the Irradiation Field

For radiation dosimetry, the standard dosimeters are used. The primary standard dosimeter is prepared in Electrotechnical Laboratory, and secondary standard dosimeters that users refer to are calibrated with the primary standard dosimeter. When selecting standard dosimeters for the calibration of γ -ray dosimeters, the geometry and other characteristics of the radiation system must be taken into consideration. VICTREEN type 500 Radcon dosimeter and type 550-3 ionization chamber (330ml) were adopted as standard dosimeters at the Radioisotope Research Center. These types of dosimeters and detectors are commonly used at other laboratories of Osaka University and outside the university, and therefore comparison of data is straightforwardly made among laboratories in and outside the university. A standard dosimeter is shown in Photo. I -3. Corrections of the calibrated standard dosimeter is necessary for the effect of temperature and atmospheric pressure in the irradiation room. The exposure (C/kg) was converted to the air-absorbed dose (Gy) by using an average ionization energy of $W = 33.85$ eV.

Figure. I -2 represents the results of MCNP calculation for different sizes of the collimator aperture. In the calculation, the irradiator was approximated by a column, and three types of rectangular collimator

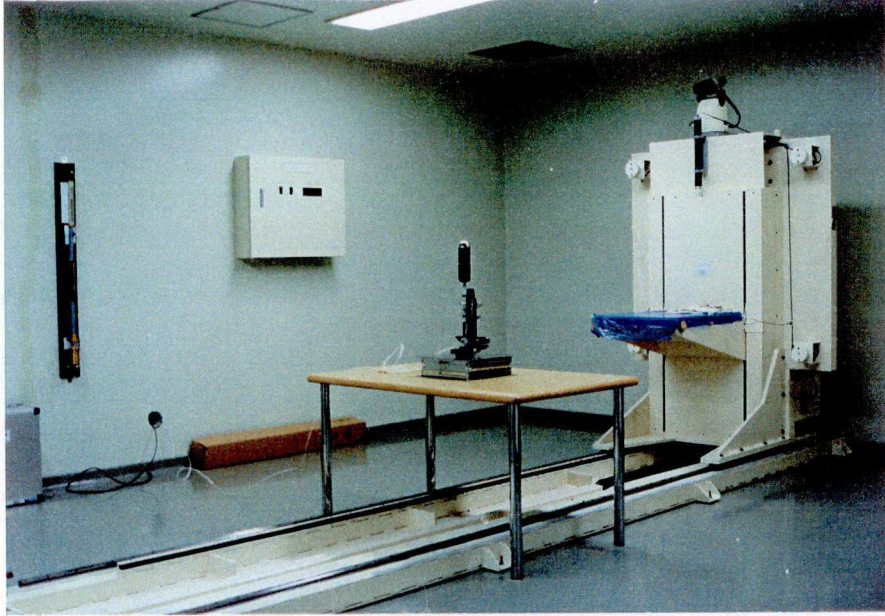

Photo.1-3 The standard dosimeter

apertures were assumed; namely $3\text{cm} \times 5\text{cm}$, $6\text{cm} \times 8\text{cm}$, and $9\text{cm} \times 11\text{cm}$. The energy spectra at 1m from the source were calculated for the three collimators when a point source of ^{137}Cs was placed at a height of 1.2m. The results indicate that the effect of scattered radiation becomes smaller as the size of collimator aperture is decreased. If sufficient collimation is provided, the contribution of scattered radiation can mostly be removed from energy spectra, except for a weak peak of 180-deg Compton scattering at about 180keV (indicated with an arrow in Fig. I -2).

The effect of the shield installed on the mobile exposure deck on the background in the calibration area was measured by using a pocket dosimeter (Fig. I -3). The measurement was carried out by placing the mobile shield at a distance of 2.2m from the source and the pocket dosimeter at the same height as the source (1.2m). The used pocket dosimeter was ALOKA FDM-101, which was detectable for γ and X rays having the energy of 60keV or more. As shown in Fig. I -3, no significant effect of the shield was observed when the distance from the source was set at 0.8~1.3m. However, the background dose rate decreased as the distance from the shield decreased to about 62.5% of that observed at 1m from the source. This is probably because a part of the natural radiation is cut off by the shield.

To investigate the effects of the mobile shield and the collimators on scattering, the dose rate was measured with a reference dosimeter as a function of the distance from the source and compared with the results of MCNP calculation (Fig. I -4). The model used for calculation was the same as the one used for the results in Fig. I -2. Dose rates

at several places between 0.5m and 2.2m from the source were calculated when the mobile shield was placed at 2.2m from the source. The absorbed dose rate at 0.5m from the source was found greater than that for the case of no scattering effect by 3%, while the difference was calculated to be 10%. A similar effect was observed at 0.2m from the shield. The results indicate that the scattering effect is significant at places close to the collimator-equipped radiator or the mobile shield, but is minimal at places near the midpoint between the source and the shield.

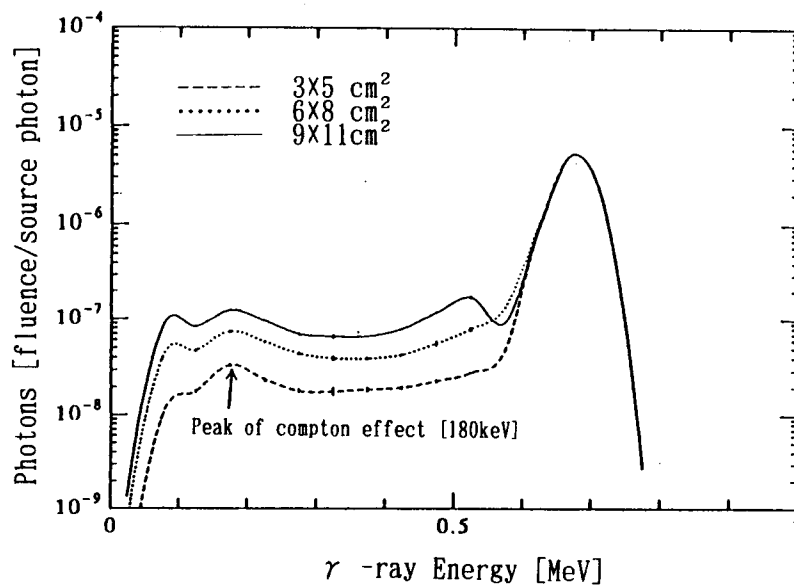

Fig. I-2 Calculated energy spectra from ¹³⁷Cs source passing through the collimator with exit dimensions of 3X5, 6X8, 9X11cm²

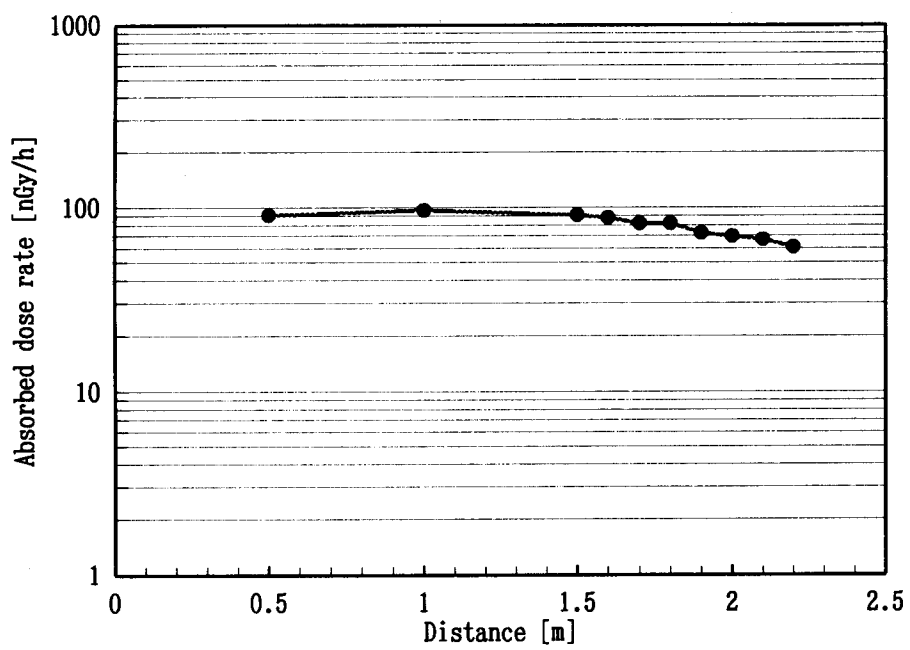

Fig. I-3 Absorbed dose rates of background on distance

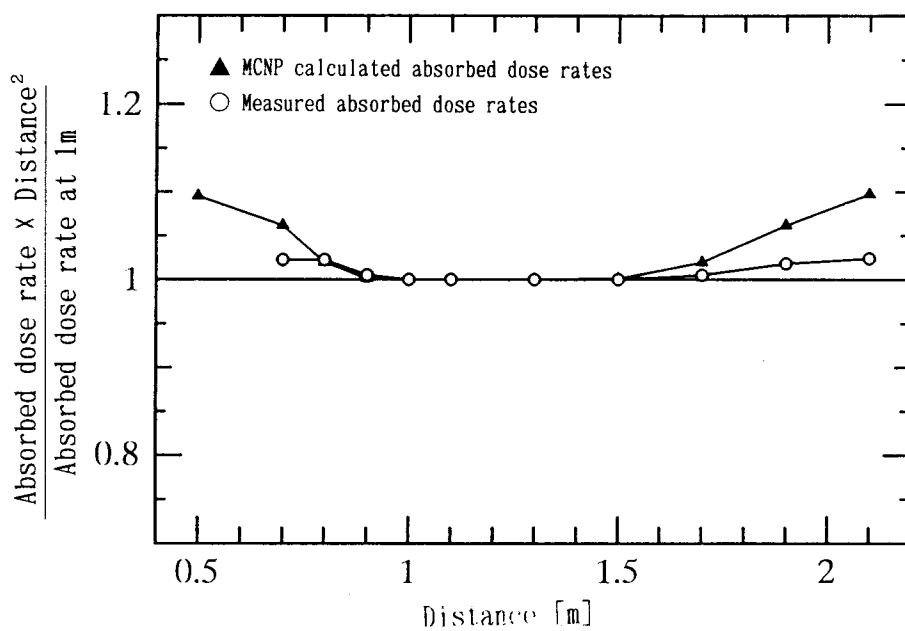

Fig. I-4 Dependence of normalized absorbed dose rates on distance

I-3-2 Results and Discussion

When the irradiation system is used for detector calibration, the distance between the source and the shield should be set to 2m or more, and the detector be placed around the midpoint according to the present study of the irradiation condition. The effect of scattered radiation could be minimized by creating a suitable calibration field by means of a collimator with the smallest aperture size. It was concluded that the present irradiation system could be used for providing the standard calibration field for γ -ray dosimeters used in Osaka University.

At present, Osaka University has 21 facilities using radioisotopes or accelerators. These facilities have many γ -ray dosimeters including more than 200 survey meters and about 700 personnel external exposure monitors for personnel, such as pocket dosimeters, thermoluminescence dosimeters and so on. Reliability of dosimetry is expected to be highly improved by means of the present irradiation system by regularly calibrating the γ -ray dosimeters and conducting performance tests if necessary.

Universities in Japan which have such a standard irradiation field are only Osaka University and Tohoku University. Especially, the one installed in Osaka University is noteworthy because of its high-precision irradiation field.

I-4 Utilization of the Standard Field

I-4-1 Calibration of the Survey Meters

This subsection describes the result of the calibration of the survey meters using the irradiation field. A survey meter is set on a laboratory jack fixed on the table as shown in Photo. I -4. Generally, a rate meter of self-reading is installed in the survey meter. So that the dose to be calibrated cannot be read out in the irradiation field. The dose rate is displayed as a reflected image of the rate meter in the monitor screen at the control room as shown in Photo. I -5.

The results of calibration of an ionization chamber survey meter, type ISC-311 manufactured by Aloka Co., LTD., are exemplified in Table I -3. The correction factor was 1.01 for the range of $300 \mu \text{ Sv/h}$ and 0.98 for the range of 1mSv/h when the detector was exposed to a ^{137}Cs source with the dose rate of $256.2 \mu \text{ Sv/h}$. Furthermore, the correction factor became 0.96 for the ranges of 3mSv/h and 10mSv/h when it was exposed to the radiation with the dose rate of 2.51mSv/h . On the other hand, the calibration using a ^{60}Co source gave the correction factor of 1.08.

In the calibration, the image of rate meter reflected on the monitor screen is magnified to about 4 times. Accordingly, the readings of detector can be exactly read out. This system can be applied to the calibration of the GM survey meter, NaI scintillation survey meter and so on.



Photo. I -4 Photograph of a setup of the irradiation system for calibration of an ionization chamber survey meter

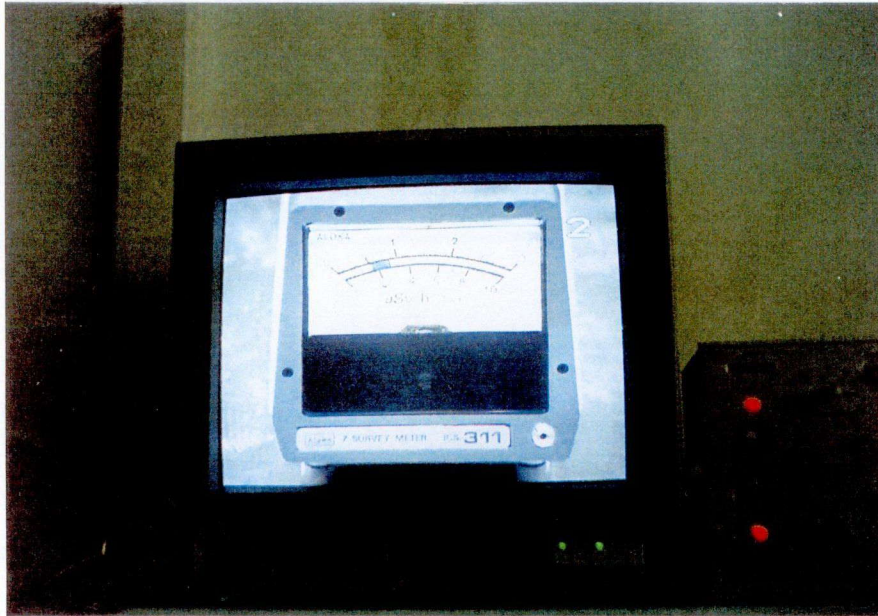

Photo.1-5 The rate meter which is reflected in the monitor screen when calibrating an ionization chamber survey meter

Table I-3 Calibration result of the ICS-311 type ionization chamber survey meter which is made by the ALOKA CO.,LTD

Irradiation Source	Dose Equivalent	Range	Indication Value	Correction Factor
^{137}Cs	256.2 $\mu\text{Sv/h}$	300 $\mu\text{Sv/h}$	260 \pm 5 $\mu\text{Sv/h}$	1.01
^{137}Cs	0.256 mSv/h	1 mSv/h	0.25 \pm 0.01 mSv/h	0.98
^{137}Cs	2.51 mSv/h	3 mSv/h	2.4 \pm 0.05 mSv/h	0.96
^{137}Cs	2.51 mSv/h	10 mSv/h	2.4 \pm 0.1 mSv/h	0.96
^{60}Co	258.8 $\mu\text{Sv/h}$	300 $\mu\text{Sv/h}$	280 \pm 5 $\mu\text{Sv/h}$	1.08
^{60}Co	0.259 mSv/h	1 mSv/h	0.28 \pm 0.01 mSv/h	1.08

I -4-2 Calibration of the Personal External Exposure Monitors

The personnel dosimeter was calibrated by setting in JIS Phantom as shown in Photo. I -6. The calibration phantom for X and γ ray personal dosimeters are described in JIS Z 4331. A JIS Phantom of 40cm(W) \times 40cm(H) \times 15cm(D) was used in the present study. This Phantom is made of methacrylate resin whose density is 1.19 g/cm³.

Calibration was undertaken for semiconductor pocket dosimeters of type PDM-102 (Aloka Co., LTD) and thermoluminescence dosimeters of type UD-812Q14 (Matsushita Electric Industrial CO., LTD). The results of calibration of the personal dosimeters as summarized in Tables I -4 and I -5 respectively.

The correction factor is given by the following formula;

$$K' = \dot{X}_s \cdot f \cdot t / I_c,$$

where

K' : the correction factor, \dot{X}_s : the exposing dose rate,
 f : the conversion factor(¹³⁷Cs is 1.18), t : the irradiation time,
and I_c :the indication value.

Obtained correction factors of PDM-102 lay in a range from 0.99 to 1.05 and the average correction factor was 1.02. A ¹³⁷Cs source was used for calibration and the dose used for calibration was 40.99 μ Sv/15min. PDM-102 exhibited quite a stable counting rate. The correction factor of UD812Q14 was relatively stable ranging from 0.72 to 0.88 and the average correction factor was 0.81 but the readings were about 20% high.

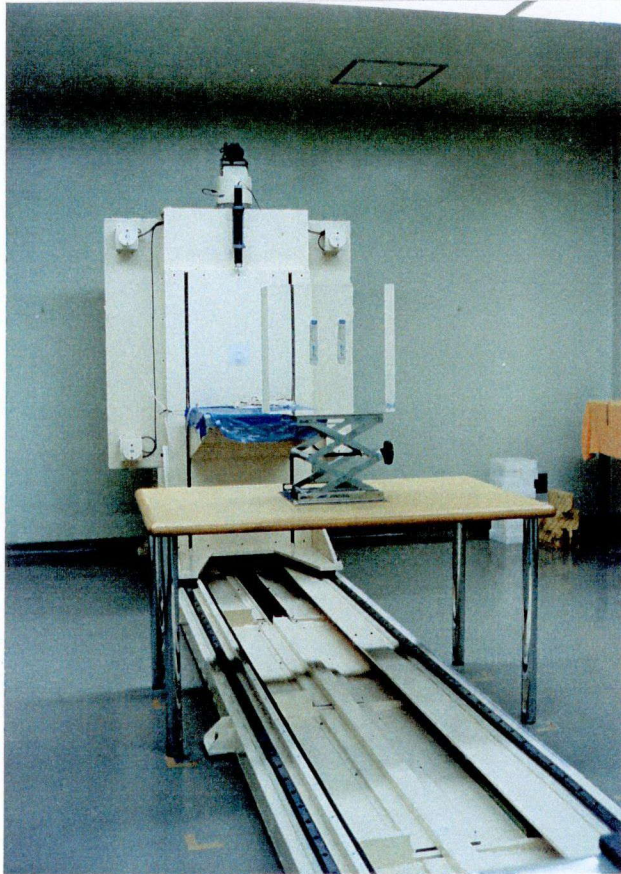

Photo. I -6 Photograph visualizing calibration of the
pocket dosimeters using JIS Phantom

Table 1-4 Results of calibration of the PDM-102 type semiconductor pocket dosimeter which is made by the ALOKA CO.,LTD

Irradiation source : ^{137}Cs
Dose equivalent : 40.99 μGy
Irradiation time : 15 min
Irradiation method : Irradiated the dosimeters in the setting to JIS Phantom

Dosimeter No.	Dose equivalent / 15min				Correction factor
	1st	2nd	3rd	Average	
PDM-102 07046	49	49	49	49	0.99
PDM-102 07047	48	47	49	48	1.01
PDM-102 07048	47	46	48	47	1.03
PDM-102 07049	47	48	46	47	1.03
PDM-102 07050	47	48	46	47	1.03
PDM-102 07071	49	49	49	49	0.99
PDM-102 07073	48	48	48	48	1.01
PDM-102 07074	48	49	47	48	1.01
PDM-102 07075	46	46	46	46	1.05
PDM-102 07076	46	46	46	46	1.05
Average	47.5	47.6	47.4	47.5	1.02

Table 1-5 Results of calibration of the UD-812PQ14 type thermoluminescence dosimeter which is made by the Matsushita Electric Industrial CO.,LTD

Irradiation source : ^{137}Cs

Dose equivalent : 40.99 μGy

Irradiation time : 15 min

Irradiation method : Irradiated the dosimeters in the setting to JIS Phantom

Dosimeter No.	Dose equivalent / 15min				Correction factor
	1st	2nd	3rd	Average	
UD-812PQ14 208	57	58	56	57	0.85
UD-812PQ14 209	61	60	62	61	0.79
UD-812PQ14 210	61	60	62	61	0.79
UD-812PQ14 211	56	55	57	56	0.86
UD-812PQ14 212	62	60	64	62	0.78
UD-812PQ14 213	55	54	56	55	0.88
UD-812PQ14 214	59	60	58	59	0.82
UD-812PQ14 215	56	58	54	56	0.86
UD-812PQ14 216	67	66	68	67	0.72
UD-812PQ14 217	62	61	63	62	0.78
Average	59.6	59.2	60.0	59.6	0.81

I-4-3 Irradiation on Mice

This irradiation system was planned to apply to medical studies as well as calibration of dosimeters. One of the original purposes was to irradiate small animals with the low dose rate of high precision.

In the present study, mice were irradiated at a low dose rate using the irradiation system. For irradiation of mice, a substitution method was applied, namely, the irradiating sample was set at the position where the dose rate had been determined accurately with the standard dosimeter. C.B.17 +/+ and C.B.17 scid/scid mice were exposed to 1.200Gy radiation for 53hours 38minutes to investigate the radiosensitivity and recovery capability from the radiation hazard. C.B.17 mouse have not C cell and B cell, and +/+ means a wild type and scid/scid means a severe combined immunodeficiency type. In the case of C.B.17 +/+, the fetal death was 4.8% and malformation was 2.4%, while, the fetal death was 72.4% and malformation was 100% in the case of C.B.17 scid/scid. The result showed the scid/scid cell has predominantly high radiosensitivity compared to the +/+ cell.

The dose rate utilized in the present study was 0.00037 Gy/min. Such a low-dosage-rate irradiation became possible for the first time by developing a high precision irradiation field.

I-4-4 Summary

A highly reliable and easy-to-operate irradiation system was designed and the radiation field was evaluated. The installed irradiator is capable to supply high-precision radiation field continuously changeable for a wide range by automatically switching irradiation sources and collimators.

Radiation monitors must be regularly calibrated with a known standard field. Radiation facilities in Osaka University have many γ -ray dosimeters including more than 200 survey meters and about 700 personnel external exposure monitors such as pocket and thermoluminescence dosimeters. The reliability of the radiation control was highly improved establishing the regular calibration of the γ -ray detectors by this system. Furthermore, the system enabled for the first time the low-dose irradiation for medical studies with high precision.

References to Chapter I

- [1] Y. Yamaguchi, J. Yamamoto, T. Nomura and J. Yamashita, The 29th Annual Meeting on Radioisotopes in the Physical Science and Industries, Proceedings 103 (1992).
- [2] Y. Yamaguchi, J. Yamamoto, T. Nomura and J. Yamashita, The 28th Annual Meeting on J. Health Phys. Soc., Proceedings 3 (1993).
- [3] S. Takeoka, T. Tsujimura, T. Kuroda, M. Kawami, S. Sawada, Annual Report of Res. Inst. for Nuclear Medicine and Biology, Hiroshima Univ., 28, 127 (1987).
- [4] MCNP-A general Monte Carlo code for neutron and photon transport, LA-7936-M (1981).
- [5] M. K. Murphy, R. J. Traub, J. C. McDonald and C. D. Hooker, Health Phys., 60, 789 (1991).
- [6] Nuclear safety Technology Center, "The manual of Shielding Calculation" (1989).
- [7] The Japan Radioisotope Association, "Isotope Handbook" Maruzen Tokyo (1996).
- [8] Y. Yamaguchi, J. Yamamoto, T. Nomura and J. Yamashita, Radioisotopes, 43, 341 (1994).

Chapter II Pre-treatment of Environment Samples for Tritium Concentration Measurements

II-1 Environmental Tritium and the Liquid Scintillation Counting System

II-1-1 Environmental Tritium

Natural radioactive nuclides and artificial radioactivities exist as well in the environment on the earth. The natural radioactive nuclides existed from the earth birth time or kept occurring in the natural radioactive decays. Radioactivities widely distribute over the environment and exist in a variety of forms in every material. The nuclides of U and Th series and ^{40}K are well known.¹⁾ Artificial radionuclides were discharged into the environment by the nuclear tests and the nuclear reactor accidents. ^{90}Sr and ^{137}Cs were the typical nuclides and they diffuse over the wide area. Radioactivities are released from the nuclear energy facilities, accelerators and radioisotope-using facilities. Thus, various radioactivities are widely distributed in our environment and exist in air, food, water, soil and the human body.

There is a radioactive hydrogen isotope called tritium (^3H) which is conventionally expressed as T. The decay scheme of tritium²⁾ was shown in Fig. II -1. It emits a low energy β -ray of the maximum energy of 18.6keV, an average 5.7keV, and the half life is 12.33 year. When tritium is taken into the body, the internal exposure lasts long

and becomes serious though the β -ray energy is low. In future, the use of tritium will increase at the nuclear facilities, accelerators and the radioisotope laboratories. Therefore, tritium is the very nuclide for which the change of the environmental concentration level should be constantly observed. The occurrence source of tritium is classified mainly into the following three groups.³⁾

- (1) Natural occurrence by the cosmic rays in the atmosphere.
- (2) Fall out by the nuclear test of the atomic and hydrogen bombs.
- (3) Discharge during reprocessing of the nuclear fuels.

The main process of each occurrences is shown below.

- (1) The natural occurrence



- (2) The nuclear test



- (3) The nuclear reactor

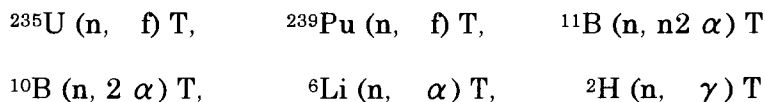

The circulation of tritium is illustrated in Fig. II -2. The chemical form of tritium at the occurrence is T_2 , HT or other T-compounds. It is released into the environment and changes the chemical form to HTO by the microorganism and the isotopic exchange reaction. Occurred HTO diffuses and permeates all areas. Especially, it widely distributes over the water and air zones in the form of water or steam. Water is taken in the body fluid and the organization of indispensable materials of the creature.

Liquid scintillation counters (LSC) are generally used for the

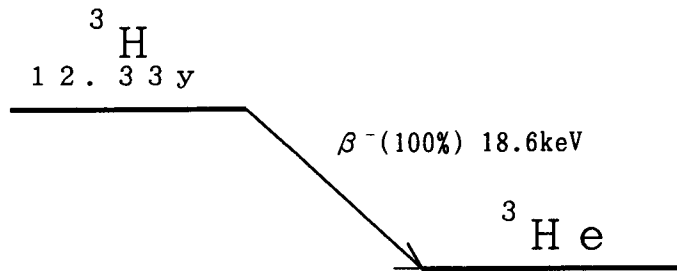

Fig.II-1 Decay Scheme of Tritium

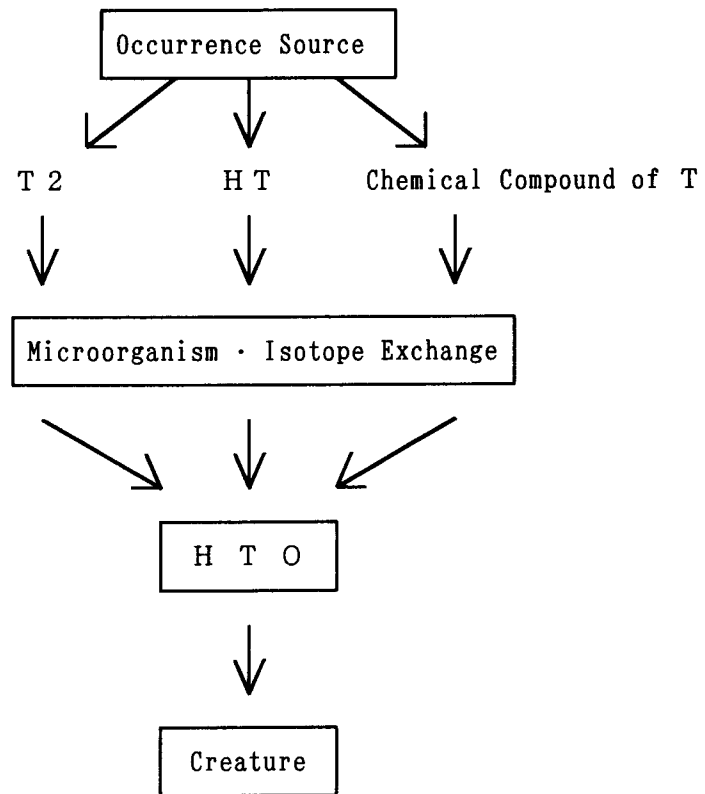

Fig.II-2 Circulation of Tritium in Nature

measurement of tritium emitting a low energy β -ray.⁴⁾ Measuring samples are land water, drinking water, sea water, rainwater, steam, and creature samples. All of these samples are "water". Land water implies extracted water from soil and the water of the river, lake, marsh and pond. Drinking water means tap water, underground water and so on. Creature samples cover water extracted from the animal, plant, water plant and seaweed. The samples of creatures such as animals and plants were burned completely to extract moisture and to measure the total tritium concentration.

Recently, it is distinguished between tritium in the form of water movable to the interior and exterior of the cell and organic tritium which was combined with the carbon to compose a cell. The former is called "free water" extractable by distillation, while the latter is called "organization water" which is extracted by the burning of the residue of distillation. The ratio between the weight of free and organization water is about three to one.

They are to be separately measured as the tritium concentration. The tritium concentration in free water is more or less the same order of magnitude as that of around water. On the contrary, the tritium concentration of organization water is higher than that of around water by a factor from 2 to 10. When measuring the tritium concentration, therefore, the organization water must be carefully removed from the free water in order to exclude the influence of its high concentration.

II-1-2 Liquid Scintillation Counting System

Tritium measurement was carried out with a liquid scintillation counter (LSC), because of its low-energy β -ray. The radiation measurement technique by liquid scintillation obtained a result which is remarkable in the study or the practical use. A prototype of the LSC as the marketing product was developed in Los Alamos Scientific Laboratory by Hiebert and Watts ⁵⁾ in 1953. The instrument equipped a coincidence circuit with the resolving time of 1 μ s. They also developed a high voltage power supply, photo multiplier tube, preamplifier, amplifier, and pulse height analyzer. The current model is nearly the identical model with the original one. In 1961, the instrument was partly transistorized and the resolving time of coincidence circuit was improved to 60ns. With this instrument, the ³H counting efficiency was raised to 30% and the background was reduced to less than 50cpm. The ³H measurement became easy by the appearance of the LSC and the tracer study of ³H developed rapidly. For the measurement cocktail samples are made by mixing water sample with the liquid scintillator. The liquid scintillation measurement has the following merits and demerits.

(Merit)

- ① There is no self absorption.
- ② Contribution of scattered radiation is negligible.
- ③ 4 π detection geometry is acquired.

(Demerit)

- ① The counting efficiency falls with quenching by the impurities and so on.
- ② Chemical luminescence is generated occasionally depending on the sample which hinders the scintillation measurement.

Despite the above defects, the liquid scintillation measurement has much higher detection sensitivity than the other measuring methods because of the high counting efficiency and low background.

The tritium measurement in the present study was carried out mainly with a LKB Quantulus 1220 type liquid scintillation system. A photograph of the Quantulus 1220 type LSC is shown in Photo.II-1. The Quantulus provides very low background values. The shielding consists of layers of purified Boliden lead (low specific activity), copper, and cadmium, and of a liquid scintillation guard counters surrounding the optical assembly and photomultiplier tubes. Accumulation of static electricity and radon build-up are also prevented. Background radiation is further reduced by 30% without reducing the counting efficiency by use of high purity Teflon/copper counting vials supplied by LKB. Further, it adopts the BECKMAN LS6500LL type liquid scintillation system for comparison. The photograph of LS6500LL is shown in Photo.II-2. LS6500LL is a liquid scintillation system which is specially designed for the low level measurement. It is equipped with function of pulse timing measurement to reject background signals as much as 50%. The pulse height analysis of the input signal is possible by a multi-channel analyzer of 32,768

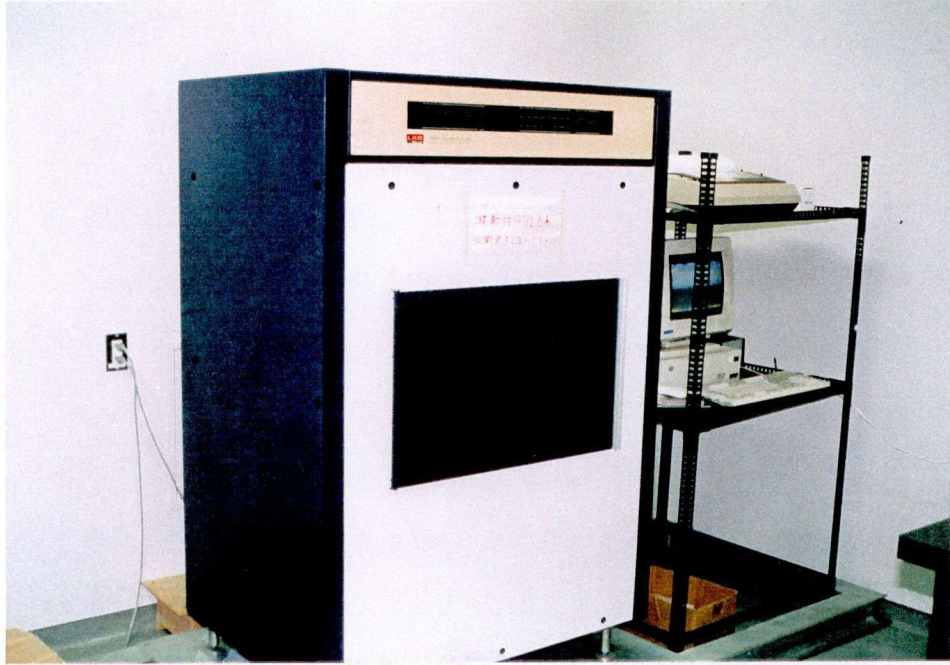

Photo.I-1 LKB Quantulus 1220 type liquid scintillation counter



Photo.I-2 Beckman LS6500LL type scintillation system

channels.

As for the liquid scintillation measurement, the moisture content changes the counting efficiency. Samples are sometimes distinguished by the percentage of moisture and scintillator. The relationship between the moisture content and the counting efficiency which was measured with Quantulus is shown in Fig.II-3. The counting efficiency decreased at the moisture content of 20% and increased again at around 30% moisture content. The counting efficiency becomes minimum at around 40% moisture content. It is concluded the suitable moisture is about 30% for tritium measurement.

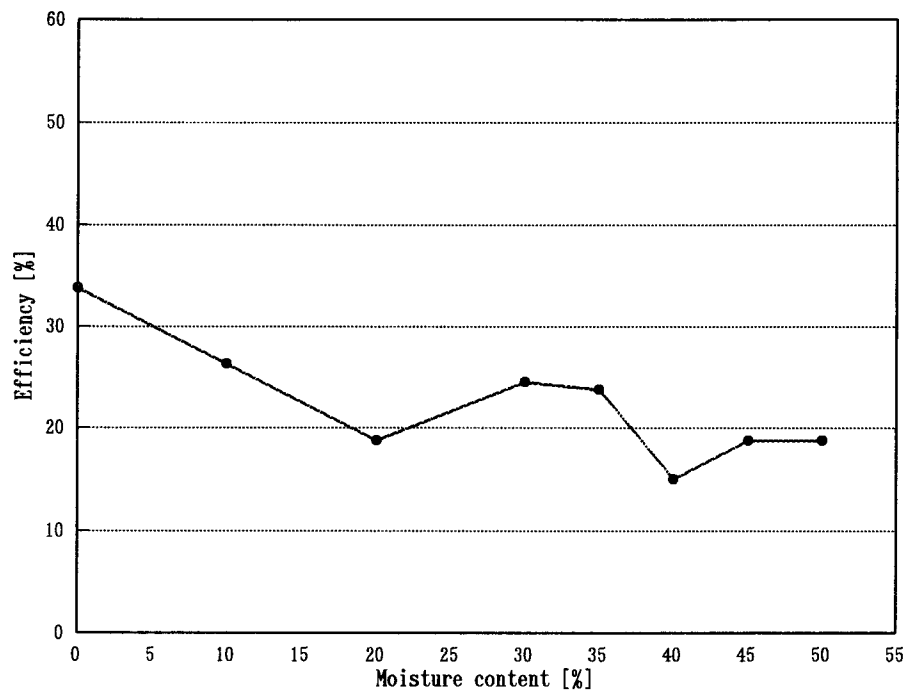

Fig. II-3 The relation between moisture content and efficiency of the liquid scintillation counter

II-2 Pre-treatment of Samples by the Reduced-Pressure Distillation System

II-2-1 Design of the Reduced-Pressure Distillation System

Osaka University consists of Suita and Toyonaka campuses, in which 21 facilities handling radioisotopes, etc. exist. Particularly, there are a variety of facilities such as a facility for nuclear fusion study, accelerator facilities, those using unsealed radioactive sources, and medical facilities in the Suita campus. Under such environment, the levels of radioactivity pollution and aerial radiation dose should be continuously monitored in the campus and circumference area. Especially, in future, it is necessary to watch over the environmental pollution of tritium which will be used in quantities at nuclear fusion facilities and hot laboratories. We must therefore prepare for such a situation by grasping the present tritium level and the fluctuation time to time.

Generally, environmental tritium samples are prepared by extracting moisture from pine needle and soil, and measured with the LSC.⁶⁾ For the extraction of moisture often used are a commercial vacuum distillation equipment and a low temperature ashing equipment. Unfortunately, such equipments are too expensive to be widely used among general hot laboratories. Considering that a large number of samples must be treated and many small facilities are involved in the environmental monitoring, it is highly desired that the procedure of the tritium measurement be simple and the equipment be inexpensive.

Under such a circumstance the author developed a system of distillation under reduced pressure for the environment radioactivity measurement using an ordinary chemical equipment available as a commercial product. The resulting system served in not only saving the cost of construction but also simplify the pre-treatment of samples. Thus, we could afford an expensive measurement system to attain quite high reliability for the activity measurement. The moisture in pine needle and soil was extracted by this system and measured to monitor the change of the tritium concentration for several years. 7-13)

The developed system of distillation under reduced pressure for pre-treatment of sample and the observed tritium level in the environment are described in this section.

II-2-2 Outline of the System

The constructed system for distillation under reduced pressure is shown in Fig. II -4. It consists of the following apparatuses; a hot dry bath with specially made aluminum block (iuchi SHD-1), a mantel heater (Daika Denki), a coolnit bath (TAIYO EL-150), an aspirator (TAIYO Q-I), test tubes (ϕ 24 \times 200mm), a spherical flask (SHIBATA 500), a vinyl tube (caliber 6mm), and glass tubes (outside diameter 6mm).

The pine needle was enclosed in the test tube and heated in hot dry bath. The heating temperature was 70–80°C to extract free water in the pine needle. When raising the temperature further, the organization-bound water is extracted from the pine needle. The system was kept at 20mm Torr by running the aspirator. The moisture extracted from the pine needle was collected in the coolnit bath at – 10 °C . Collection of the moisture is also possible by using ice water for cold trap. Soil was heated in the mantle heater at 70–80°C, and then generated moisture was collected in –10°C coolnit bath as in the case of the pine needle.

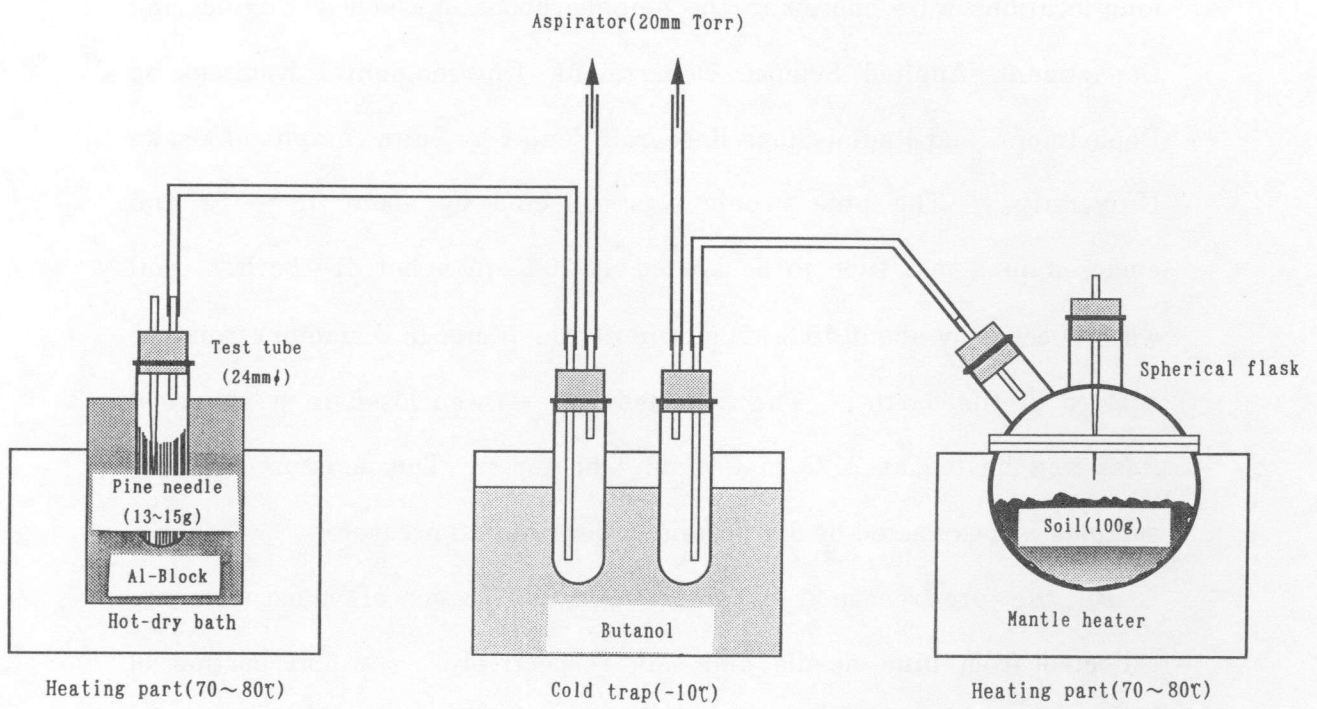

Fig. II -4 The system for distillation under reduced pressure

II-2-3 Experimental

As the check point for the environmental radioactivity measurement four locations were chosen in the neighborhoods of Nuclear Engineering Department, Applied Science Department, Environmental Engineering Department, and Radioisotope Research Center at Suita campus of Osaka University. The pine needle was collected by about 13 ~ 15g and enclosed in a test tube to be heated at 70°C in a hot dry bath. Soil was collected by about 100g (50mm in depth, 70mm in diameter) from the surface of the earth. The collected soil was enclosed in a spherical flask and heated at 70°C in a mantel heater. The moisture of these samples was extracted by distillation under reduced pressure.

By the pre-treatment, about 7 and 25 grams of moisture were collected from pine needle and soil, respectively. A 3ml portion of the water collected by the pre-treatment of either sample was taken in a low background vial (Teflon/copper) and 7ml of liquid scintillator was added to make a sample for the LSC measurement. The prepared sample was kept in a cold dark place for a few days so that the luminescence in the sample was eliminated.

A LKB Quantulus 1220 type LSC was used in the measurement. Each sample was measured for 300 min. repeatedly five times. The tritium peak was confirmed correctly by the measurement of the pulse-height distribution.

In the measurement of low level tritium the accurate background count is required to know. The background changes as the measuring

condition or the used scintillator changes. Therefore, in the measurement of low level tritium it is required to use water whose tritium content is negligible. Such water is usually called the background water. For the background water used are underground water, spa water, well water, and burning water. The tritium concentration of the Shimokawa spa water was measured as 3.26cpm by the Nagoya University Plasma Laboratory. The tritium concentration of the underground water measured by the National Institute of Radiological Science analyzed was 1.87cpm.¹⁴⁾ In the present study water extracted from the Beppu spa (the hole bottom depth of 700m, the ground temperature of 60°C at the hole bottom) was used as the background water whose tritium concentration was determined to be approximately 2cpm.

II-2-4 Results and Discussion

First, we studied the collection efficiency of moisture by means of the cold trap. The change of the moisture recovery rate of the distillation under reduced pressure with the change of trap temperature is shown in Table II-1. The recovery rate of moisture was 95.6% when the cold trap was cooled at -10°C . It reduced to 72.2% at the room temperature (20°C). The difference in the recovery rate by 23.4% is not trivial. Running of a -10°C cold trap therefore results in shortening of the pre-treatment time in the measurements requiring water in quantities.

Pine needle samples were collected at four points of the Suita campus of Osaka University and the results of the measurements of tritium concentration are shown in Figs. II-5 through 9. Figure II-5 presents the change of tritium concentration represented in unit of Bq per liter in the neighborhood of the Nuclear Engineering Department. Figures II-6 through II-8 demonstrate the results at the other three points; the Applied Engineering Department, the Environmental Engineering Department and the Radioisotope Research Center, respectively. Figure II-9 gives the average of the four data. The figures cover the time span from June, 1991 to December, 1996. The concentration of 0 Bq/liter implies that the relevant activity is below the detection limit.

Observed tritium concentrations lay in the range of 0–25 Bq/liter in all cases, while the average values among the four points were

Table I-1 Recovery rate of moisture by the reduced-pressure distillation system

	Cold bath (-10°C)	Room temperature (20°C)
Weight before treatment(g)	61.50	67.62
Weight after treatment(g)	31.15	29.46
Weight difference(g)	30.35	38.16
Collected water(g)	29.10	27.55
Recovery(%)	95.6	72.2

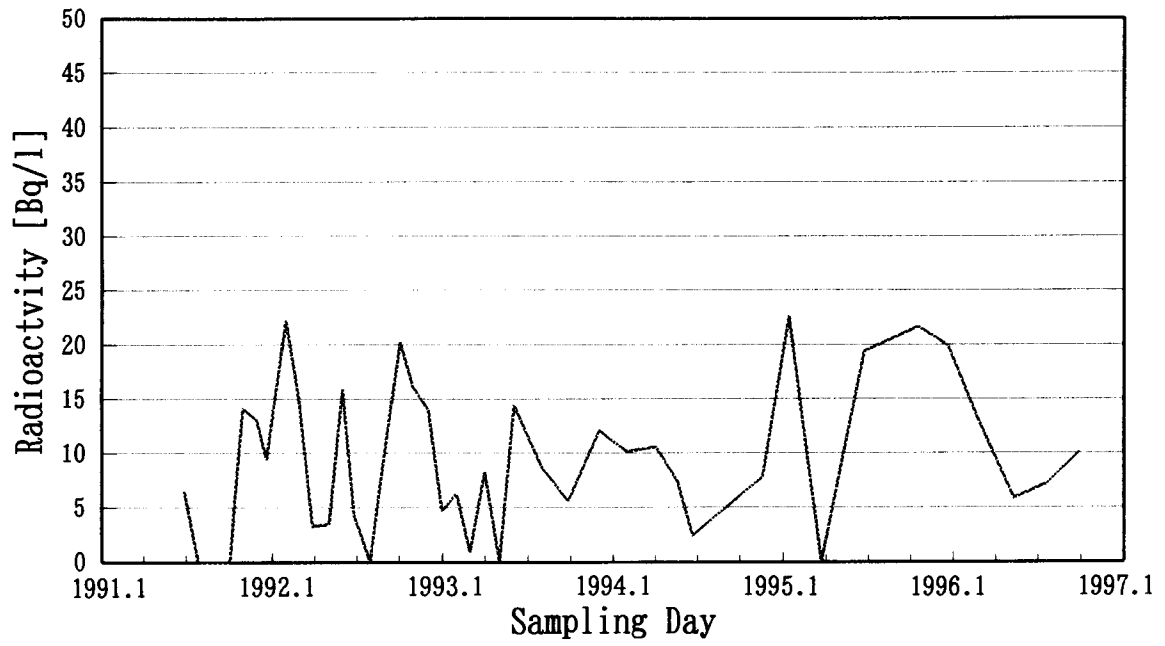

Fig. II -5 Tritium concentration in the pine needle neighborhood of the Nuclear Engineering Department

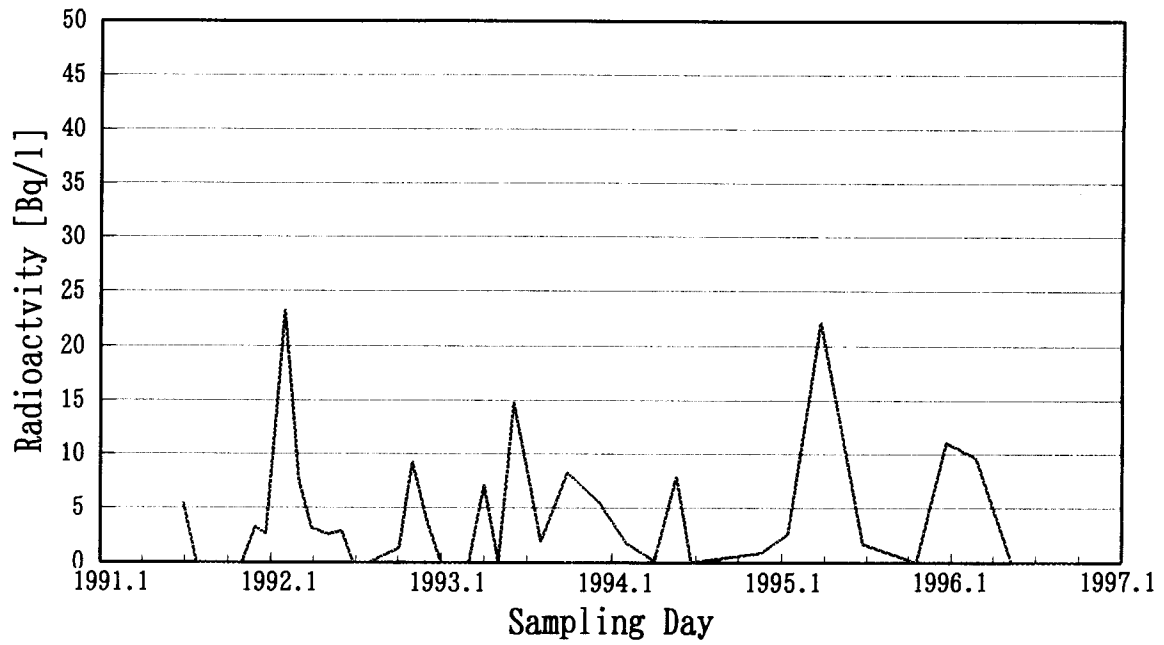

Fig. II -6 Tritium concentration in the pine needle neighborhood of the Applied Science Department

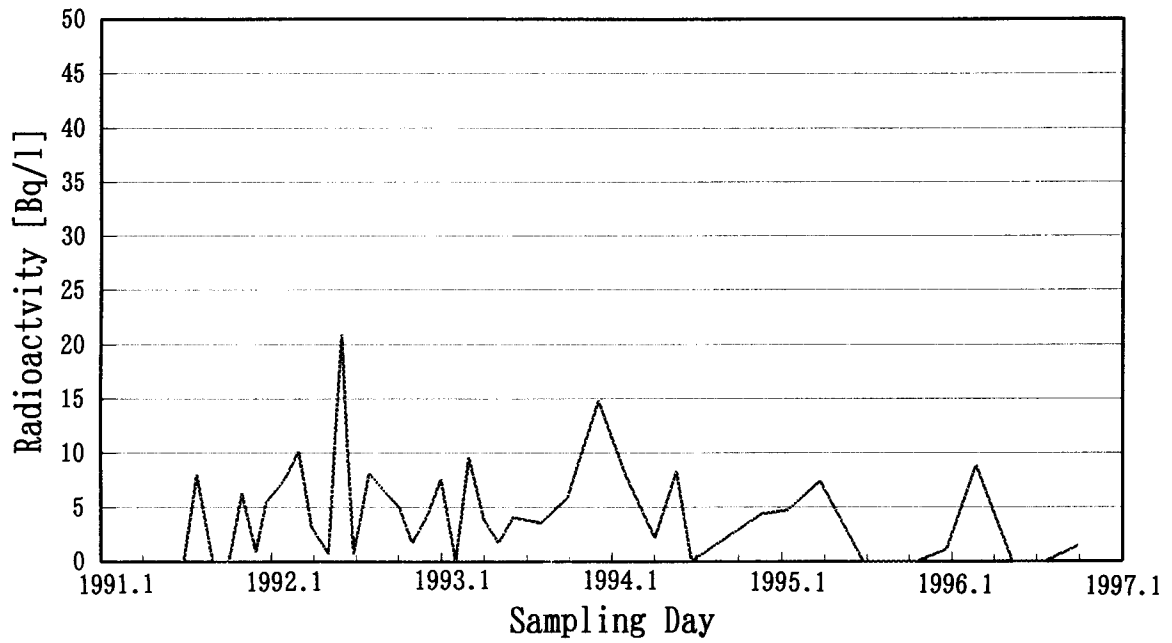

Fig. II -7 Tritium concentration in the pine needle neighborhood of the Environmental Engineering Department

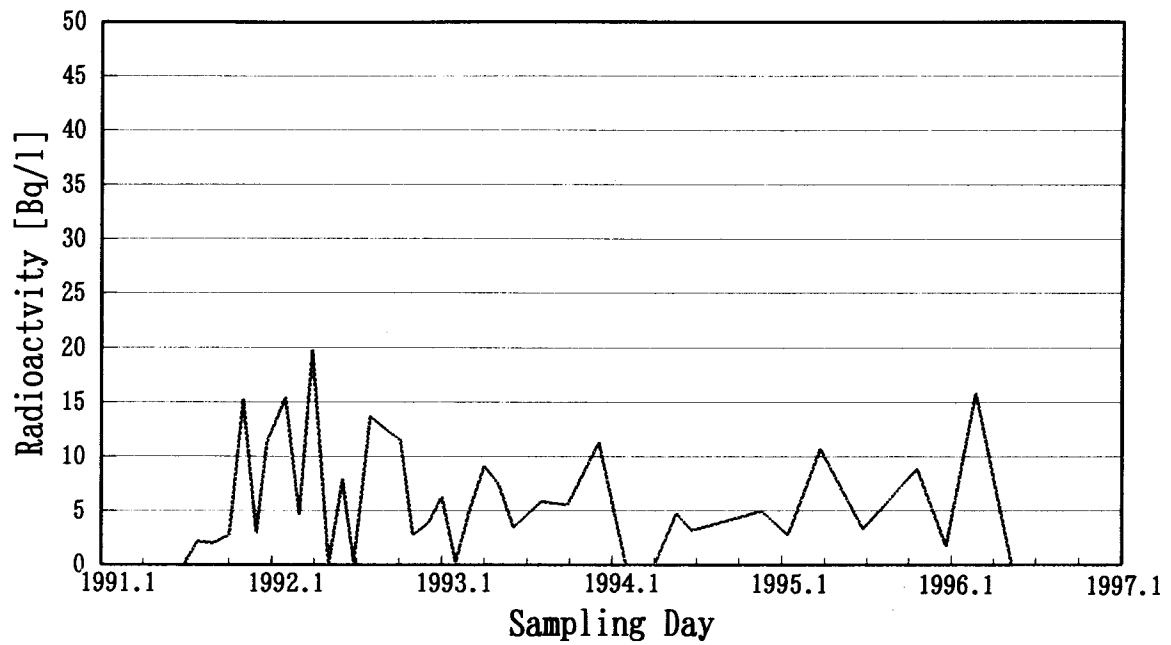

Fig. II -8 Tritium concentration in the pine needle neighborhood of the Radioisotope Research Center

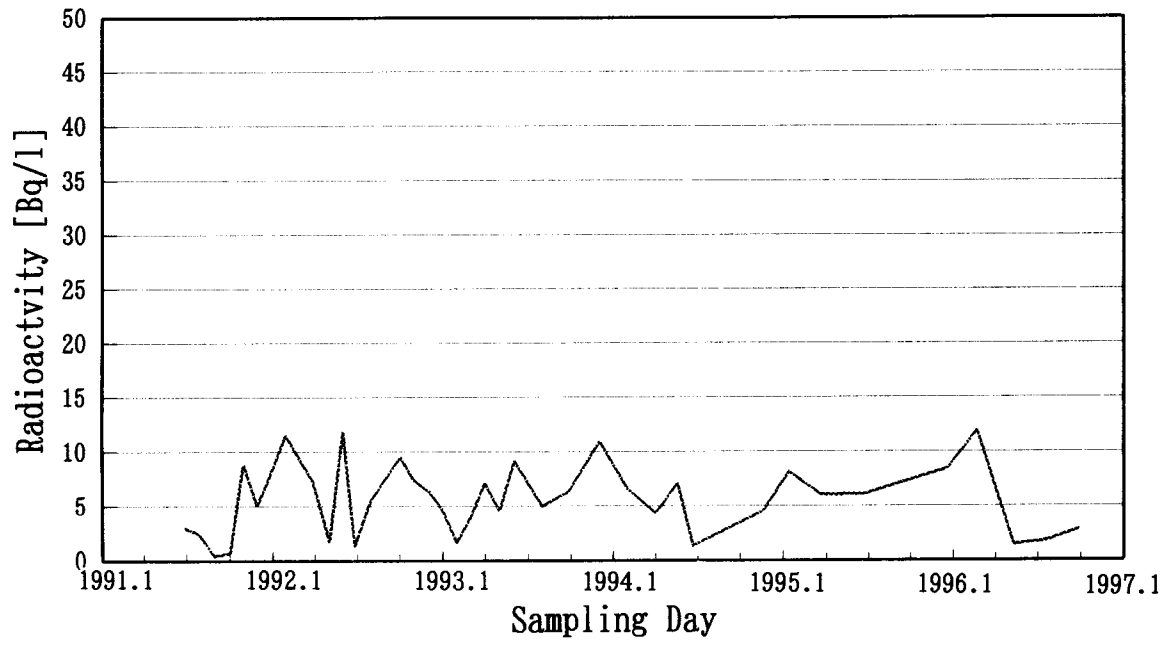

Fig.II -9 Average concentration in the pine needle for the 4 measurement points

constrained between 0~15 Bq/liter.

The measured tritium level at the Nuclear Engineering Department (Fig. II -5) distinctively high compared to the other three data. The Intense 14MeV Neutron Source Facility and the Cyclotron Facility locate near the sampling point. As a conceivable source of the high tritium concentration at the first sampling point, the possibility of neutron generation at these facilities is pointed out, which induces the nuclear reaction with hydrogen in the environment to produce tritium. This possibility should therefore be investigated in future.

On the other hand, the tritium concentration became low during the time from spring to summer in contrast to the other season for all the data sampling spots. The reason for the seasonal effect seems to be the change in tritium concentration due to the change in the atmospheric condition.

The results of the tritium measurement of moisture in the soil samples are depicted in Figs. II-10 through 14. The soil samples were taken at the previously mentioned four points of the Suita campus of Osaka University; the Nuclear Engineering Department (Fig. II -10), the Applied Engineering Department (Fig. II -11), the Environmental Engineering Department (Fig. II -12), and the Radioisotope Research Center (Fig. II-13). Further, the average values of the four points are plotted in Fig. II-14. The figures represent the tritium concentrations in unit of Bq/liter during June, 1991 and December, 1996. Incidentally, the concentration of 0 Bq/liter implies that the activity is detection limit as before.

All the measured tritium concentrations for the four sampling

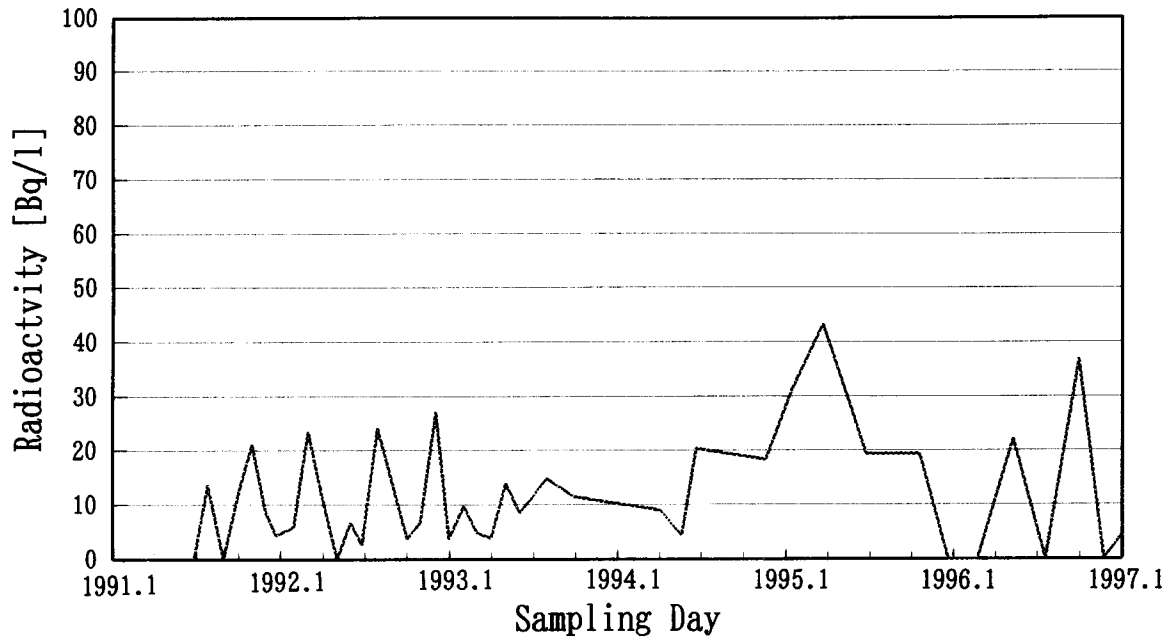

Fig. II -10 Tritium concentration in the soil neighborhood of the Nuclear Engineering Department

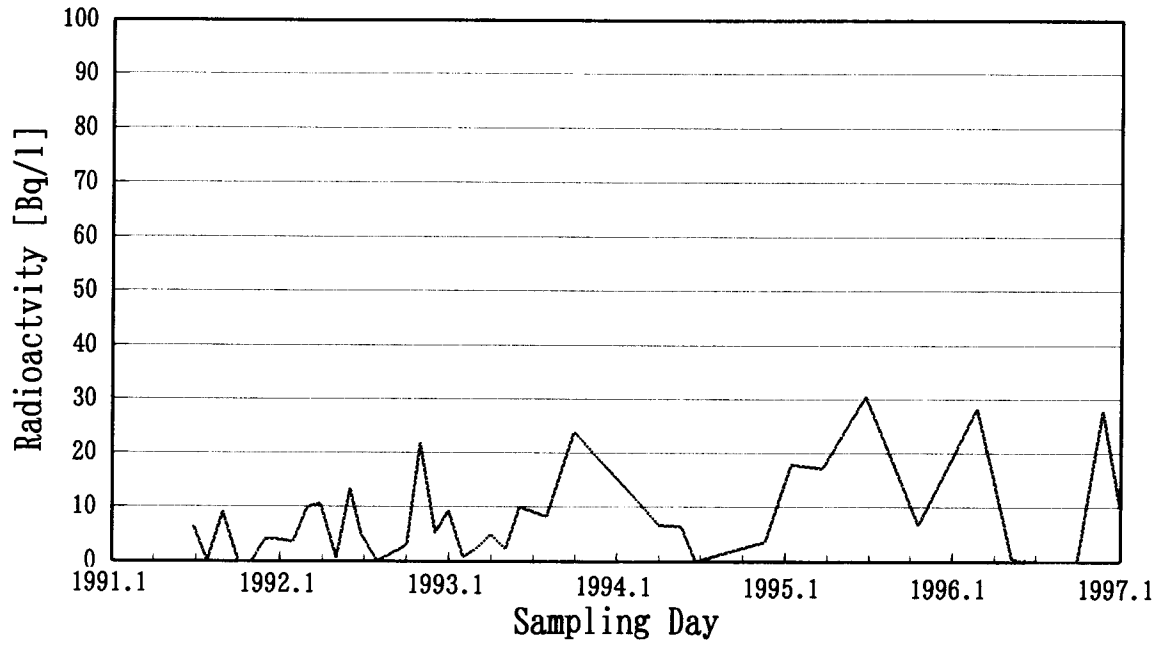

Fig. II -11 Tritium concentration in the soil neighborhood of the Applied Science Department

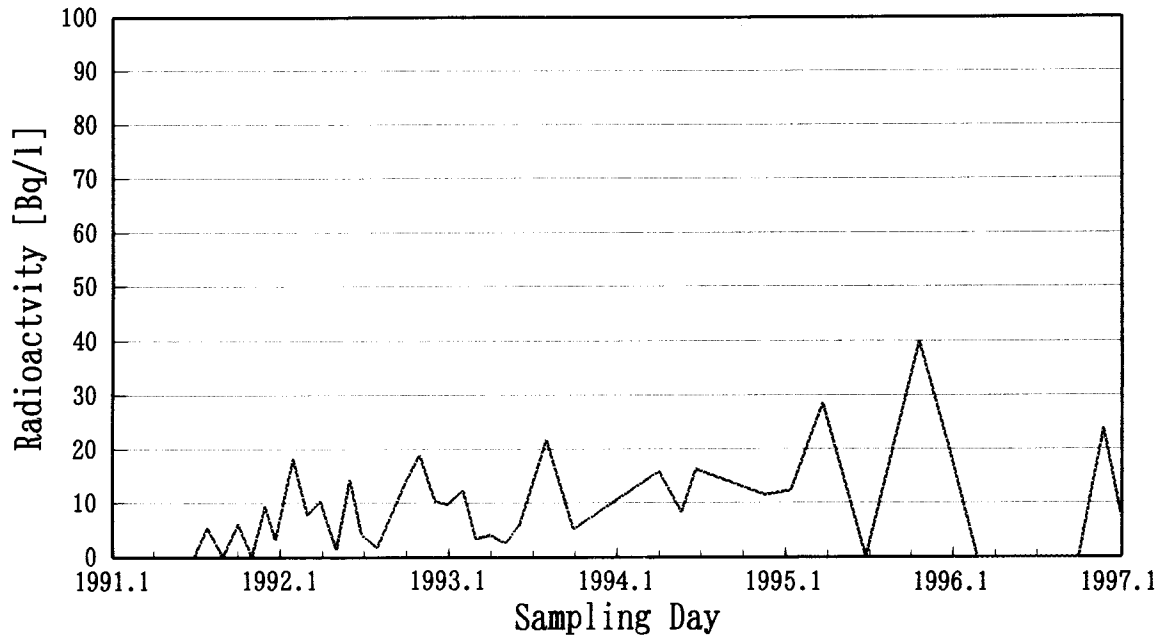

Fig. II -12 Tritium concentration in the soil neighborhood of the Environmental Engineering Department

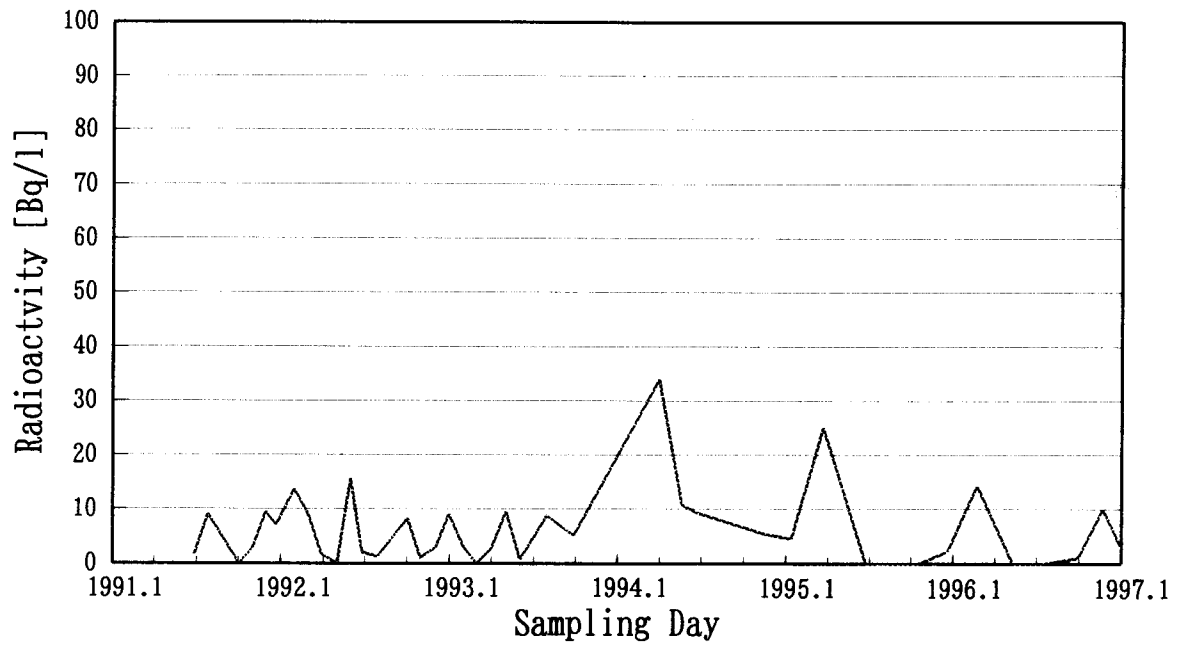

Fig.II -13 Tritium concentration in the soil neighborhood of the Radioisotope Research Center

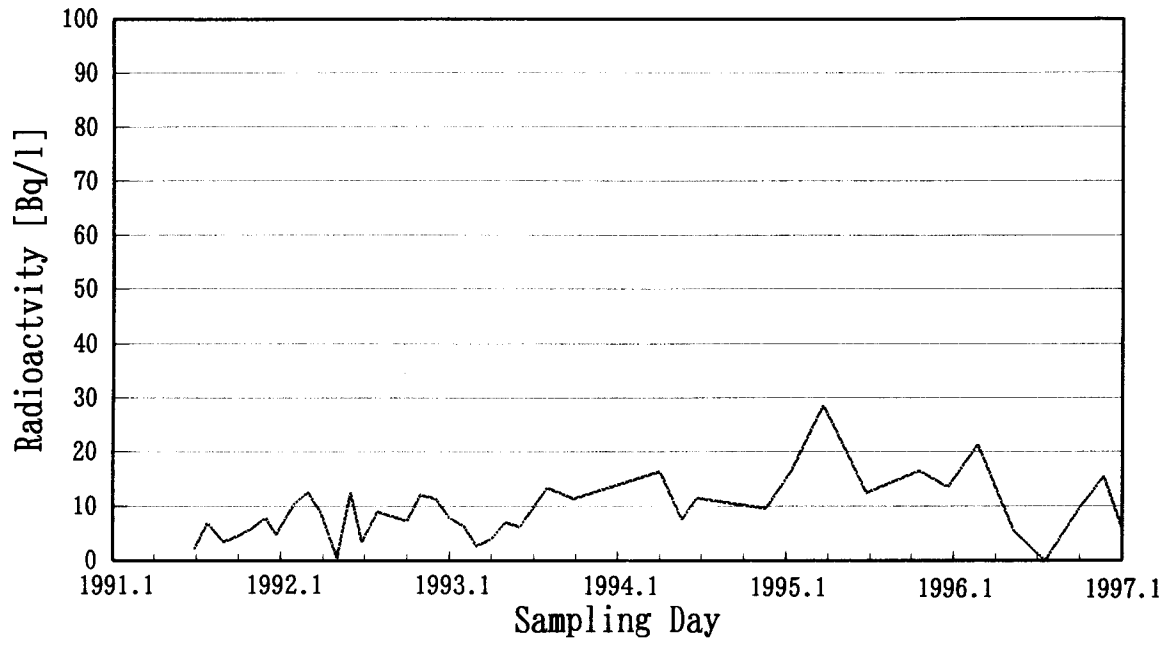

Fig.II -14 Average concentration in the soil for the 4 measurement points

points stayed within the range between 0–40 Bq/liter. The tritium concentration in the vicinity of Nuclear Engineering Department (Fig. II-10) was again distinctively high compared to the other three data. This result is consistent with the case of pine needle samples. Hence, the possibility of neutron generation in the operation of the Intense 14MeV Neutron Source and the Cyclotron is reinforced.

The observed tritium concentration at the Radioisotope Research Center was temporarily high in 1994 as shown in Fig. II-13. This time period coincides with the time of enlarging construction of the facility. Tritium and other nuclides in soil diffused by digging the land. Diffused tritium was absorbed by the nearby ground. This is likely the cause of the temporary high tritium concentration. As in the case of pine needle, the seasonal change of tritium concentration may be attributed to the change in the atmospheric condition.

The pulse height spectra of the tritium measurement are shown in Figs. II-15 through II-24. Figure II-15 gives the spectra of the ^3H and ^{14}C standard samples while Fig. II-16 represents the β -ray spectrum of the background water. The β -ray spectra of moisture in pine needle samples taken at the four sampling points are presented in Figs. II-17 through II-20, while the β -ray spectra of moisture in soil samples taken at the same points are given in Figs. II-21 through II-24.

The channel number in the abscissa is converted to the energy by the following formula;

$$E = 2000 K / 1024$$

where K is the channel number and E is the energy in keV.

In Fig. II-15, the spectrum with a peak near 200 channel is for ^3H

[A] 423.536 CPM/ch 2.87 min A:\ORIS\Q#25\PSD\GLASSQ020201N.001 SP#11
 [B] 0.096 CPM/ch 986.24 min A:\ORIS\Q#25\PSD\GLASSQ030301N.001 SP#11

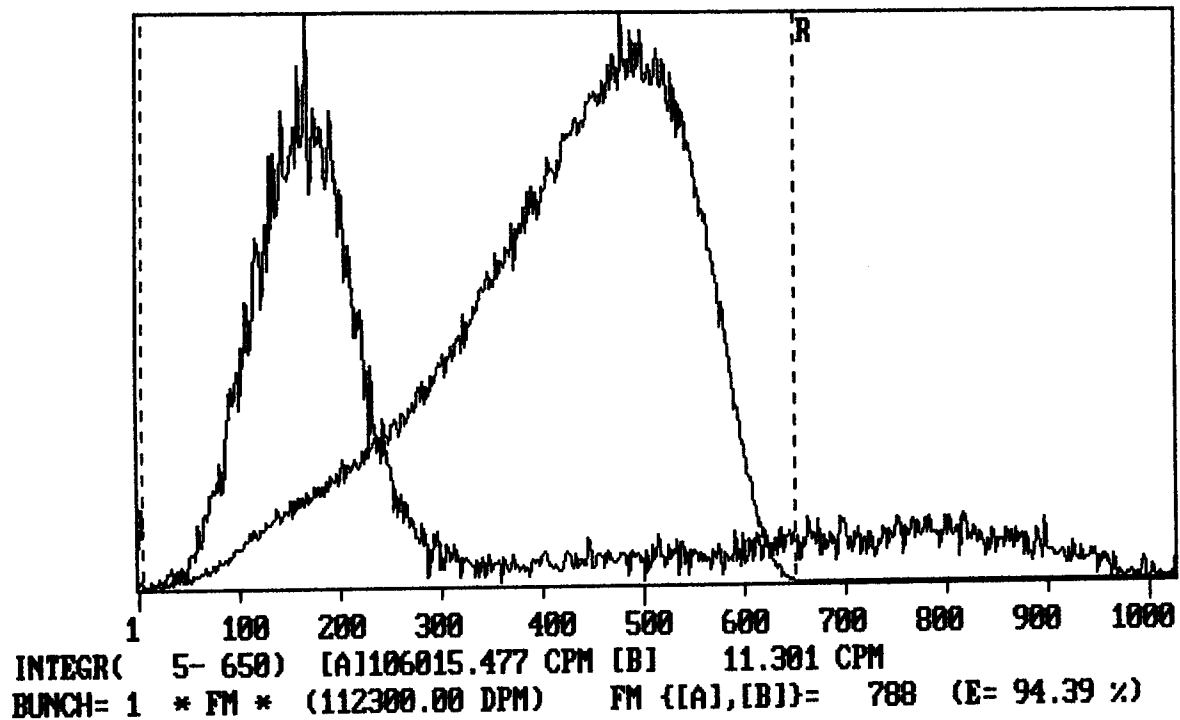

Fig.I-15 The spectrum of the standard ^3H and ^{14}C sample

(the maximum energy being 18.6keV), while the one with a peak near 500 channel is for ^{14}C (the maximum energy being 156keV).

The samples whose spectra are shown in Figs.II-17 through II-24 were collected on November 27th, 1991. The count rate of the background water integrated for 0 – 1024 channels was 2.79 cpm as shown in Fig.II-16.

The evident enhancement was observed around 200 channel corresponding to the tritium activity as seen in Figs. II -17 and 21. This indicates that the tritium level was high in the neighborhood of the Nuclear Engineering Department just as in the case of pine needle samples shown in Fig.II-5. The tritium count rate was higher than the background count rate by about 0.3cpm. The spectrum in Fig.II-24, also revealed a similar enhancement around 200 channel. This sample was collected near the Radioisotope Research Center. The sampling was practised just after the burning of 70 liters of radio-active organic waste containing low level tritium below 37 Bq/ml in a building near the sampling point. A few percents of the burnt tritium were considered to be released in the air. The tritium count rate at the date was higher than the background count rate by about 0.25cpm, whereas no enhancement was discernible in the spectrum of the pine needle sample as shown in Fig.II-20. It was considered that the soil immediately absorbed released tritium but there was a substantial delay in the tritium absorption in pine needle.

The minimal tritium concentration in the environment can not be measured in other methods or instruments. The background is 15–35 cpm in the case of a generally used LSC. The detection limit in this

[A] 0.030 CPM/ch 295.88 min \KANKYOU\911127-4\Q013001N.001 SP#12

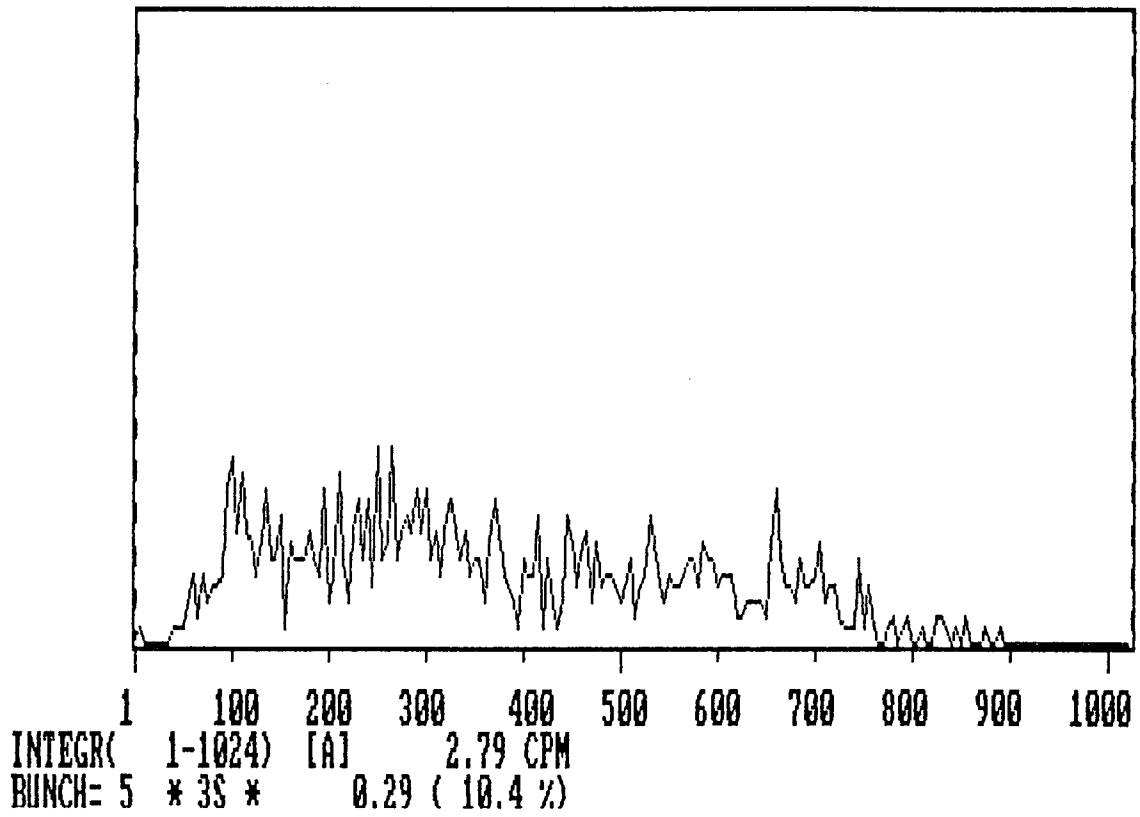

Fig.II -16 β -ray spectrum of the background water

[A] 0.030 CPM/ch 295.88 min \KANKYOU\911127-4\0012101N.001 SP#12

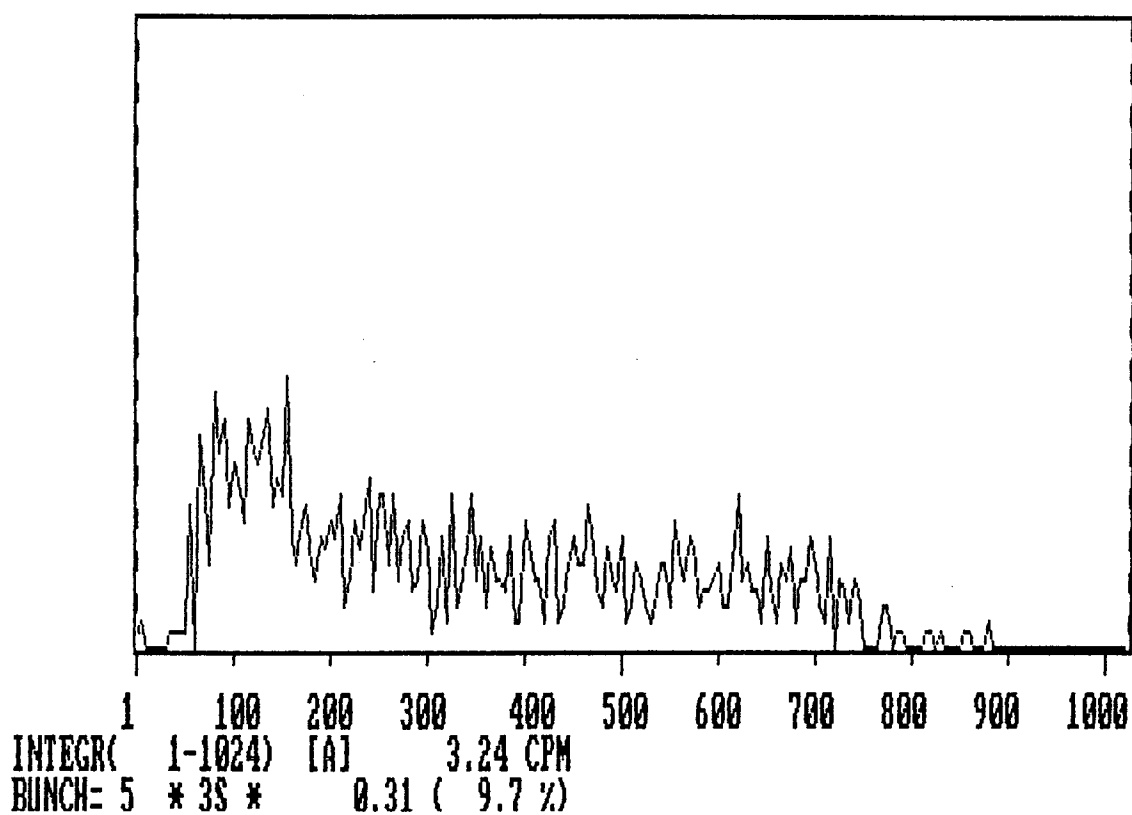

Fig.II -17 β -ray spectrum of the moisture in the pine needle neighborhood of the Nuclear Engineering Department

[C] 0.030 CPM/ch 295.88 min \KANKYOU\911127-4\0012301N.001 SP#12

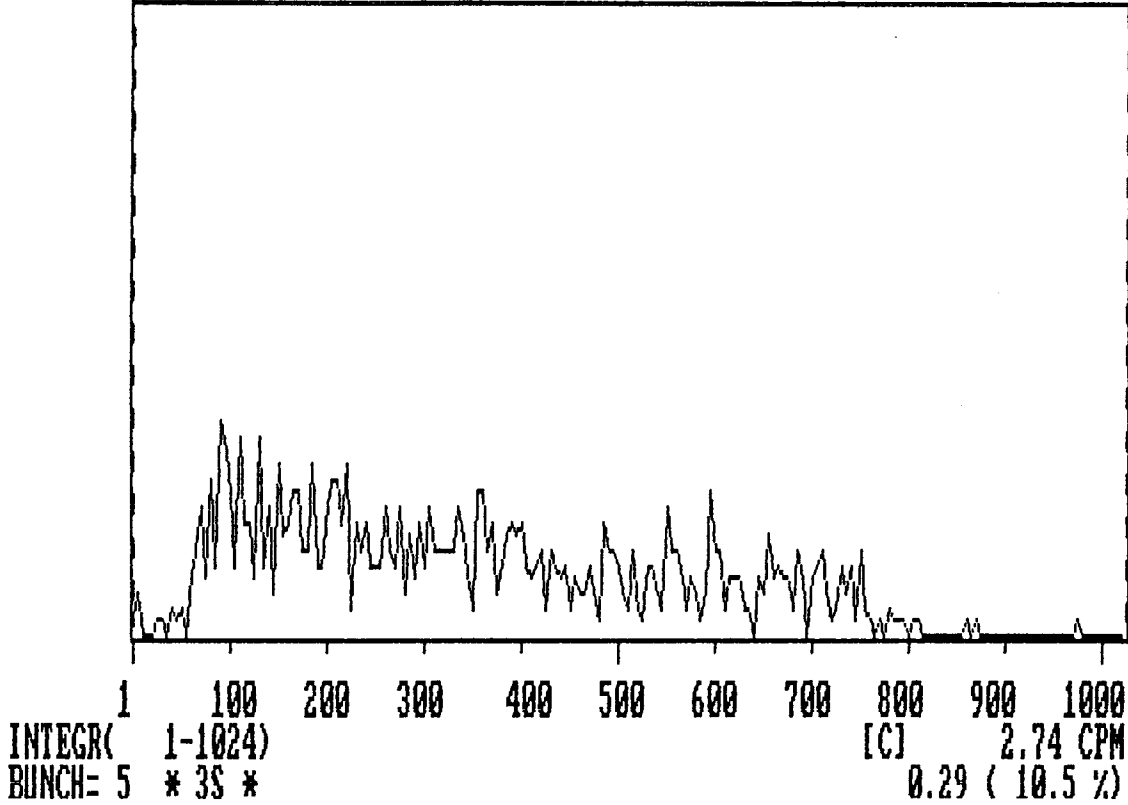

Fig. II -19 β -ray spectrum of the moisture in the pine needle neighborhood of the Environmental Engineering Department

[A] 0.030 CPM/ch 295.88 min \KANKYOU\911127-4\0012401N.001 SP#12

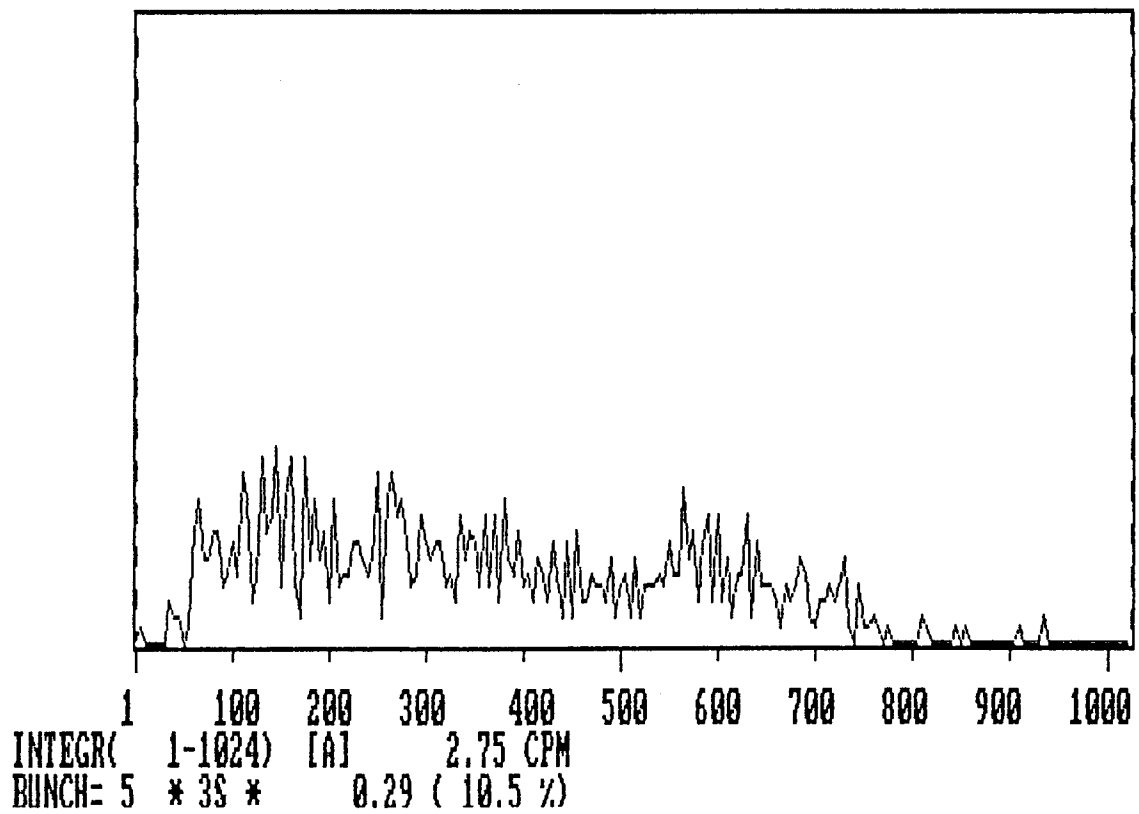

Fig. II -20 β -ray spectrum of the moisture in the pine needle neighborhood of the Radioisotope Research Center

[C] 0.030 CPM/ch 295.88 min \KANKYOU\911127-4\0012601N.001 SP#12

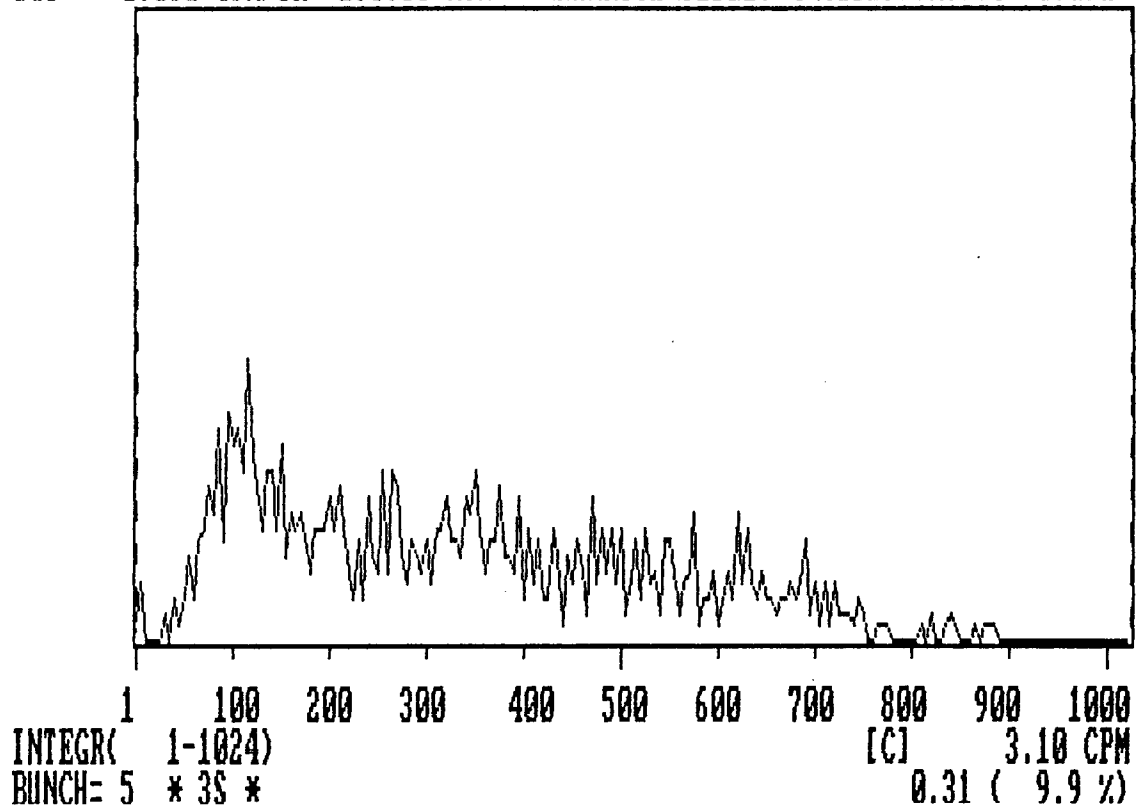

Fig. II -21 β -ray spectrum of the moisture in the soil needle neighborhood of the Nuclear Engineering Department

[A] 0.030 CPM/ch 295.88 min \KANKYOU\911127-4\0012701N.001 SP#12

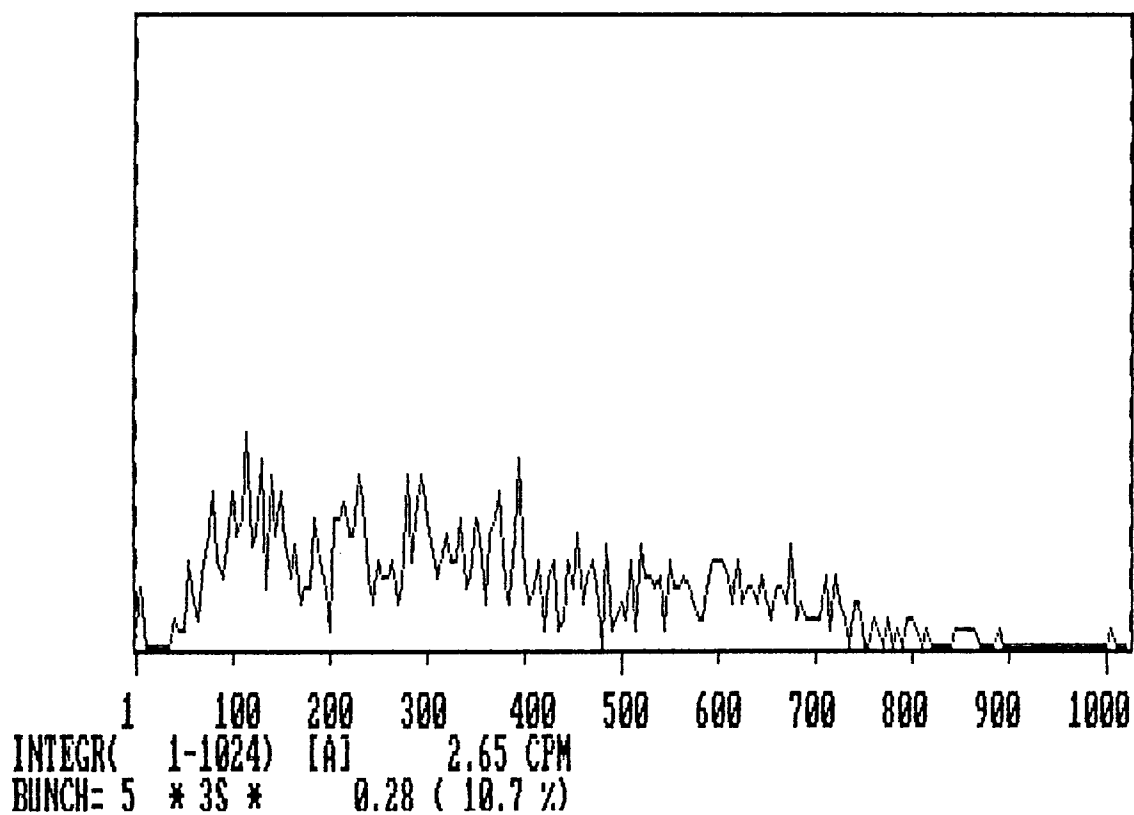

Fig. II -22 β -ray spectrum of the moisture in the soil needle neighborhood of the Applied Science Department

[B] 0.030 CPM/ch 295.88 min \KANKYOU\911127-4\Q012801N.001 SP#12

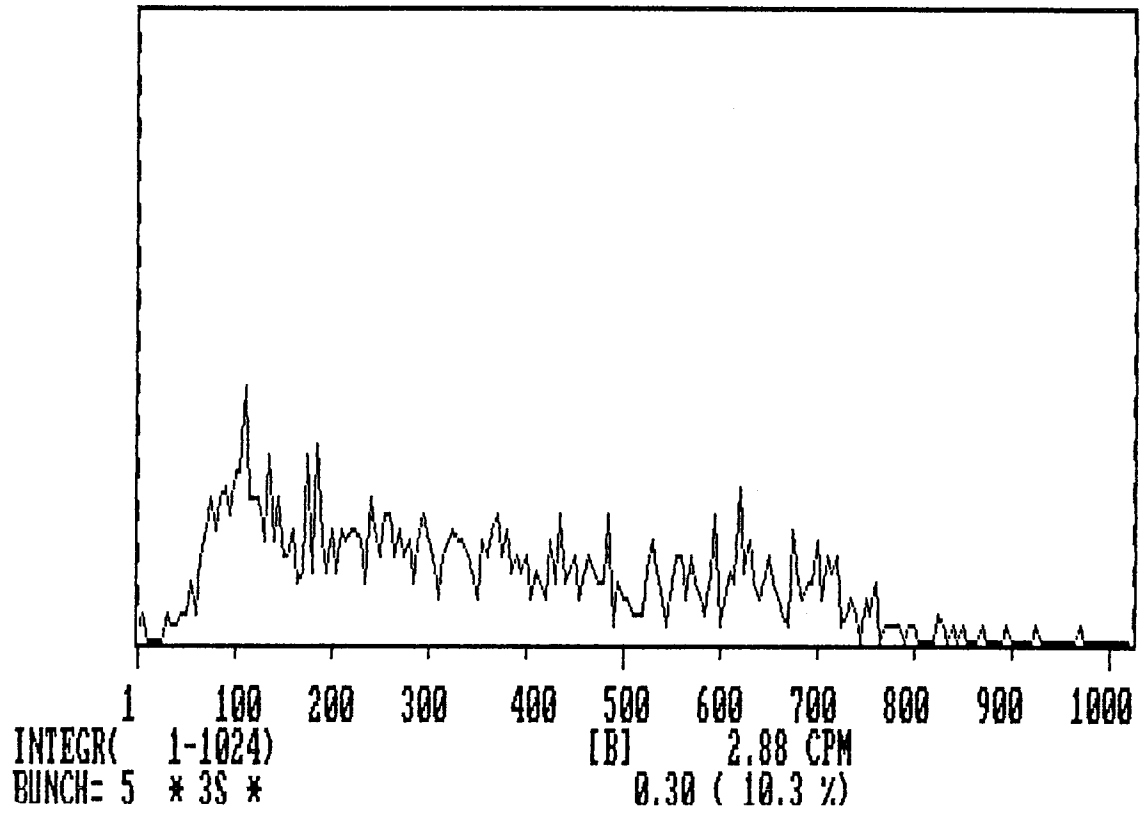

Fig. II -23 β -ray spectrum of the moisture in the soil needle neighborhood of the Environmental Engineering Department

[C] 0.030 CPM/ch 295.88 min \KANKYOU\911127-4\Q012901N.001 SP#12

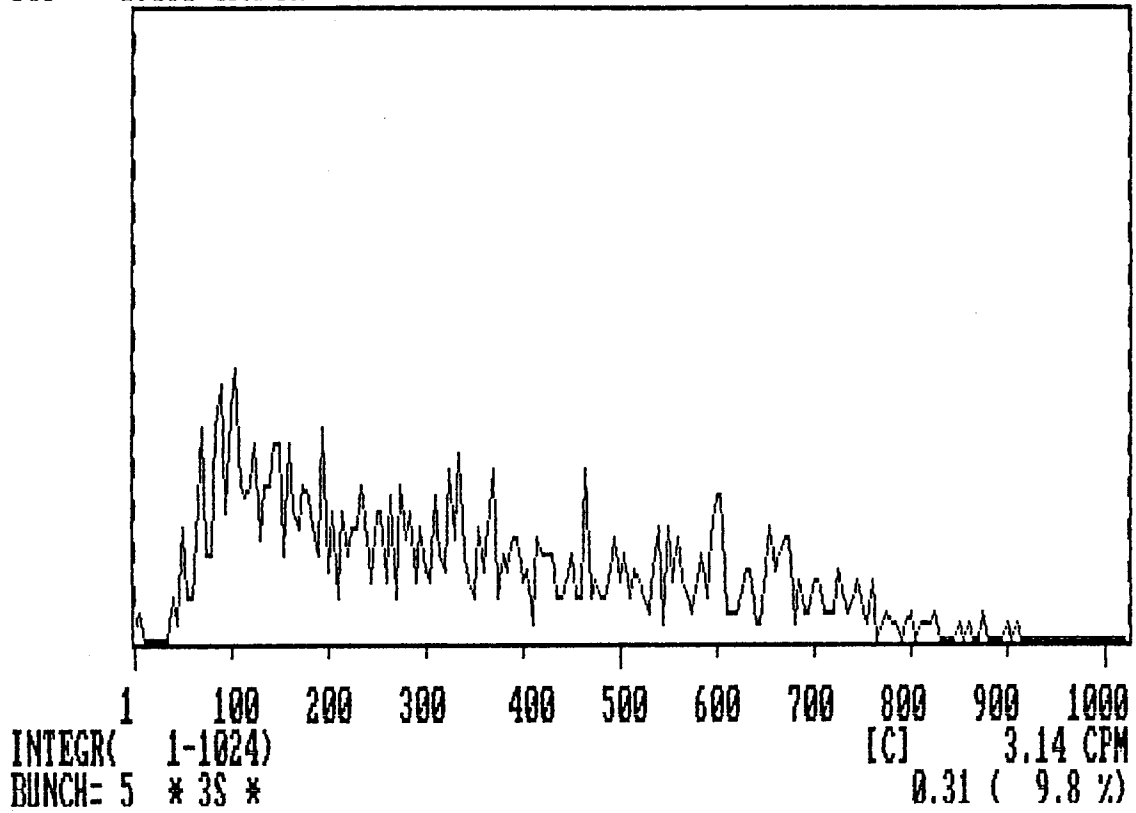

Fig. II -24 β -ray spectrum of the moisture in the soil
needle neighborhood of the Radioisotope
Research Center

case is about 1cpm for a 300 min. long counting. A measuring time of about 5000 min. is then necessary to detect the activity of 0.3cpm. However, the counting time is reduced to 100 to 300 min. for the measurement with the same quality by using a low level LSC. Therefore, in the minimal tritium measurement, a high precision counter is necessary.

The reduced-pressure distillation system developed in the present study functions satisfactorily as the pre-treatment device of the environmental radiation measurement samples. One can collect moisture in the environmental samples easily. Introduction of such an inexpensive and simple system would encourage the environmental tritium measurement even for small hot laboratories, and thus it will become possible to construct the country-wide map of the environmental tritium level.

However, a shortage of this system is that a considerably long time is required for the sample treatment. Development of a device enabling rapid pre-treatment is, therefore, quite desirable.

II-3 Pre-treatment of Samples by the Microwave Heating Distillation System

II-3-1 Design of the Microwave-Heating Distillation System

For the extraction of moisture from the environmental tritium samples generally used are a commercial vacuum distillation equipment, a low-temperature ashing equipment and a decompression distillation equipment. The Author developed a system of distillation under reduced pressure for the pre-treatment of samples which was described in Section II -2, to serve to popularize tritium monitoring among small hot laboratories. Tritium measurements at a minimal concentration in the environment not only take a long measuring time but also require a low-level counting system. In the routine environmental radioactivity measurement an inexpensive and simple procedure is inevitable to handle a huge number of samples.

On the other hand, a quick response is required in an emergency. Commercial equipments for the pre-treatment of samples are expensive and time consuming. The equipment developed in Section II -2 is inexpensive but yet time consuming. The latter takes about 3 hours to extract moisture from pine needle by distillation under reduced pressure. Furthermore, a measuring time of about 100 min. is necessary for LSC counting of one sample. The presently developed system fails to deal effectively with an urgent situation.

The author developed a new system of microwave heating distillation of pre-treatment of the sample to meet the above requirements in the

environmental tritium measurement.^{15,16)} The electromagnetic wave¹⁷⁾ is illustrated in Fig. II -25. Microwave is the electromagnetic wave which has frequencies ranging from about one to hundreds of GHz and wavelengths from several mm to about 30cm. Microwave heating has several advantages such as high-speed heating, high thermal efficiency and uniform heating. This heating method is widely applied to the home electronic range.

The microwave-assisted extraction is used for solvent extract such as the extraction of the fat in the yeast and the analysis of polychlorinated biphenyl in soil and so on.¹⁸⁻²¹⁾ However, microwave heating was not used so far for pre-treatment of environment radiation measurement samples.

Performances of the presently developed system are compared with those of the reduced-pressure distillation system, and procedures of the tritium concentration measurement using the new system are described in this section.

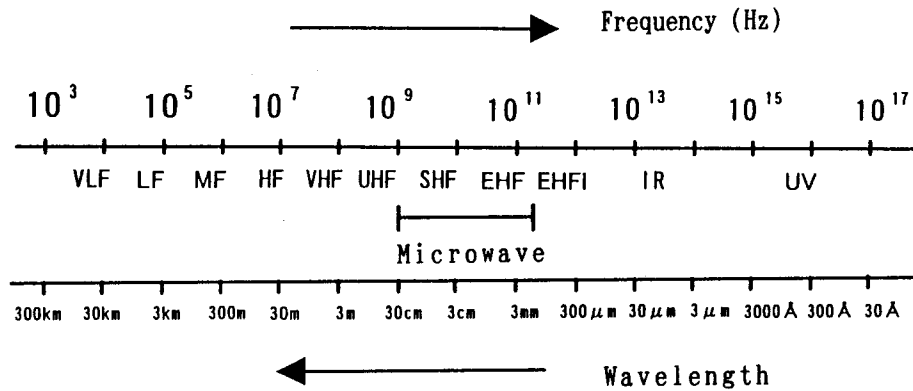

VLF : very low frequency	SHF : super high frequency
LF : low frequency	EHF : extremely high frequency
MF : medium frequency	EHF1 : extremely high frequency indeed
HF : high frequency	IR : infrared radiation
VHF : very high frequency	UV : ultraviolet radiation
UHF : ultra high frequency	

Fig.I-25 Frequency and wavelength of electromagnetism wave

II-3-2 Outline of the System

The constructed system for microwave-heating distillation is shown in Fig. II -26. It consists of the following constituents; a microwave oscillator, a cold trap (Ice water or coolnit bath at -10°C), nitrogen gas, a test tube ($\phi 24 \times 200\text{mm}$), a vinyl tube (caliber 6mm), and a glass tube (outside diameter 6mm).

The sample was enclosed in the test tube and heated by the microwave oscillator in the heating part. The frequency applied to the microwave oscillator was 2.45GHz. The moisture generated from the sample by the microwave heating was transported to the cooling part with nitrogen carrier gas via glass tube and vinyl tube and collected in the cold trap. A glass test tube was used to enclose pine needle and soil in the heating part. In this system, several useful but unnecessary accessories, such as the power monitor to detect output and the isolator to absorb reflected wave in the oscillator were omitted because the current purpose was to cut the production cost to the least amount.

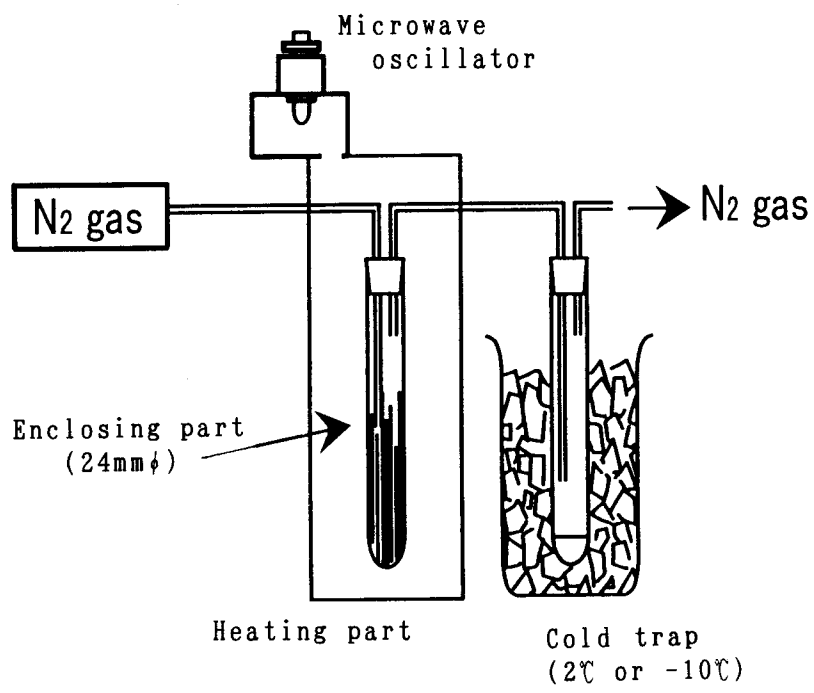

Fig. II -26 Schematic view of the microwave heating distillation system

II-3-3 Condition of Microwave-Heating Distillation

We studied the extraction condition of free water in pine needle by the developed microwave-heating distillation system. The weight of the used pine needle was about 13g as in the case of the Section II-2. The test tube in the heating part was installed about 150mm apart from the microwave oscillator considering that the wavelength of 2.45GHz microwave was approximately 120mm and the maximum amplitude of vibration was 150mm. Further, the reflected wave was cut off by installing the test tube apart from the side wall of the heating part.

The relation between the amount of extracted moisture and the output of microwave oscillator is given in Fig. II -27. Moisture extraction from pine needle began at 75W of the output of microwave oscillator and reached to an equilibrium state around 200W. This result indicates that extraction of free water ceased below 200W of the output of microwave oscillator. Then, organization-bound water starts to be extracted by raising the output of microwave oscillator further.

The sample temperature is presented vs. the output of the microwave oscillator in Fig. II -28. The temperature began to rise from 50W, it became 60°C at the 125W and at 200W it reached about 90°C. The temperature of 70 – 90 °C is appropriate for extraction of free water. Consequently, extraction of the free water of pine needle should be carried out by setting the output of the microwave oscillator to 170 –

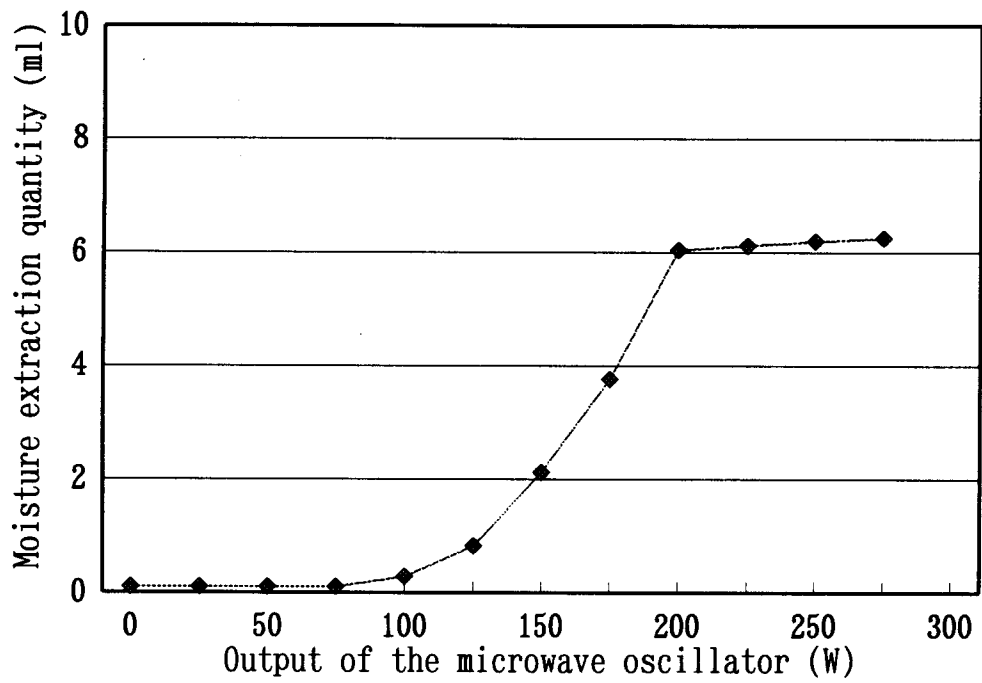

Fig. II-27 Extraction of moisture quantity vs. the output of the microwave oscillator

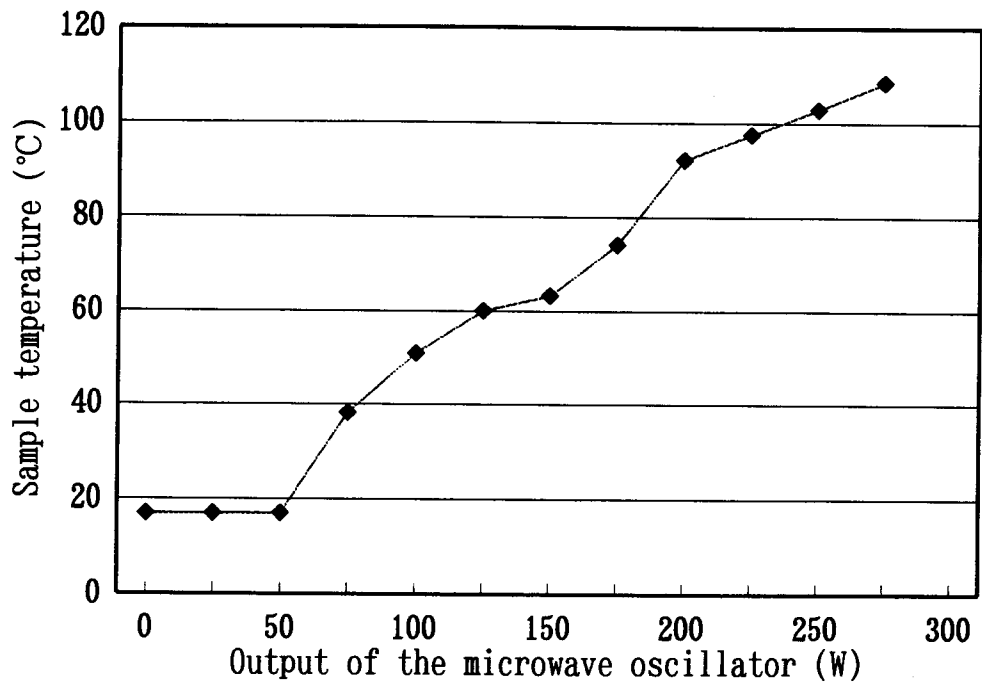

Fig. II-28 Sample temperature vs. the output of the microwave oscillator

190W.

The change of the sample temperature by the nitrogen-gas flow-rate is shown in Fig. II -29. The sample temperature becomes about 75°C when the flow-rate is 3 l/min.

The optimum condition for quick extraction of the moisture of pine needle by the developed system was 3 min. heating with microwave oscillator below 200W under the nitrogen-gas flow-rte of 3 l/min. when 13g of pine needle were used. However, this extraction condition should be slightly modified depending on the difference in the sample condition, such as the degree of hydration of the sample.

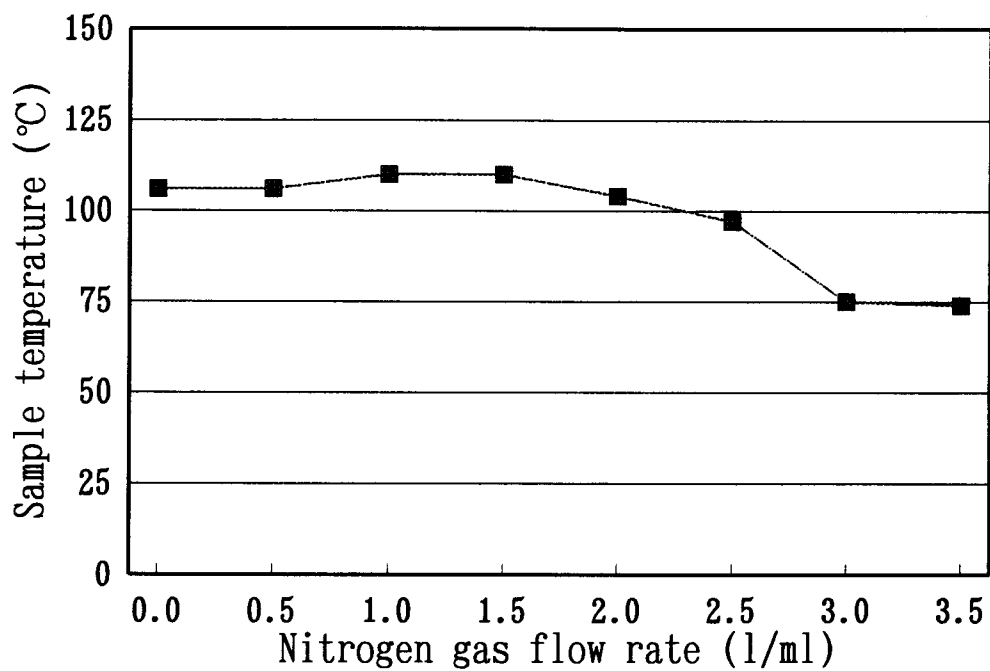

Fig.II-29 Sample temperature vs. the nitrogen gas flow rate

II-3-4 Results and Discussion

The change of the moisture recovery rate in the microwave-heating distillation with the change of trap temperature is listed in Table II-2. The recovery rate of moisture was 86.9% when the cold trap was cooled to 2°C, while the recovery rate was 95.8% when the cold trap was cooled to -10°C. The moisture recovery rate was high when the temperature of cold trap was lowered as in the case of the reduced-pressure distillation system.

Results of the measurement of the tritium concentration of the free and mixed water in pine needle for combination of extraction with the microwave-heating distillation and counting with LSC are summarized as shown in Table II-3. Here, mixed water means mixture of free and organization-bound water. The mixed-water sample was prepared by setting the output of microwave oscillator to about 280W and the sample temperature at 110°C. The tritium concentration was 0.050 Bq/ml for free water and 0.234 Bq/ml for mixed water. The latter was about 4.7 times as high as that of free water.

Tritium concentrations of extracted moisture was compared between the microwave-heating distillation and reduced-pressure distillation in Table II-4. Pine needle samples were collected in the neighborhoods of the Radioisotope Research Center, University Library Suita Branch, and Environmental Engineering Department, while soil sample was collected in the neighborhood of the Radioisotope Research Center. No differences were discerned in the tritium concentration between the

Table I-2 Recovery rate of moisture by the microwave heating distillation system

	Cold bath (-10°C)	Ice water (2°C)
Weight before treatment(g)	13.09	13.05
Weight after treatment(g)	7.32	7.34
Weight difference(g)	5.77	5.71
Collected water(g)	5.53	4.96
Recovery(%)	95.8	86.9

Table I-3 Tritium concentration measurement by Beckman LS6500LL type liquid scintillation system of the free water and mixed water in plant(pine needle) which was extracted with microwave heating distillation system

	Free water	Mixed water
Count rate (dpm/3ml)	8.98	42.05
Tritium concentration (Bq/ml)	0.050	0.234

Table I-4 Comparison of the tritium concentration of the moisture to have extracted from plant and soil by the decompression distillation and microwave heating distillation

Sampling Point	Method of Distillation	
	Microave Heating	Decompression
(Pine Needle)		
Radioisotope Res.Center	0.050 Bq/ml	0.051 Bq/ml
Univ.Library	0.048 Bq/ml	0.052 Bq/ml
Environmental Enginnering	0.049 Bq/ml	0.052 Bq/ml
(Soil)		
Radioisotope Res.Center	0.051 Bq/ml	0.049 Bq/ml

Table I-5 Tritium concentration measurement with Beckman LS6500LL type liquid scintillation system of the moisture which was extracted by microwave heating distillation

Sampling Point	Counting Rate (dpm/3ml)	Tritium Conc. (Bq/ml)
In Osaka University		
(Suita Campus)		
University Library	9.16	0.051
Res.Center for Environmental Preservation	8.96	0.050
Radioisotope Research Center	8.78	0.049
Joining and Welding Research Institute	8.70	0.048
(Toyonaka Campus)		
Student Hall	8.73	0.049
Low Temperature Center	8.98	0.050
Faculty of Science	8.18	0.045
Out of Osaka University		
Turuga, Hukui Prefecture	7.54	0.042
Matsuba, Hukui Prefecture	6.78	0.038
Ootsu, Shiga Prefecture	7.60	0.042
Sanda, Hyogo Prefecture	7.72	0.043
Kumatori, Osaka Prefecture	7.69	0.043
Soja, Okayama Prefecture	8.17	0.045
Okayama, Okayama Prefecture	7.35	0.041
Kyoto, Kyoto Prefecture	7.38	0.041

pine needle or soil samples treated by microwave-heating distillation and those treated by reduced-pressure distillation among all sampling points.

Pine needle samples were further collected at Suita campus, Toyonaka campus and out of Osaka University campuses. The results of the measurements are given in Table II-5. The average values were 0.050 Bq/ml for Suita campus, 0.048 Bq/ml for Toyonaka campus and 0.042 Bq/ml for outside of Osaka university. The tritium concentrations in the Osaka university seem to be slightly higher than the value in the outside of the university. Incidentally, the tritium level in the background water is not subtracted in the observed values, because the measurement was practiced for the condition setting of the moisture extraction by microwave-heating distillation.

The microwave-heating distillation system developed in the present study functions satisfactorily as the pre-treatment of samples for the environmental tritium measurement. The reduced-pressure distillation takes several hours for the treatment of the sample, for example, about 1 hour for soil and about 3 hour for pine needle. On the contrary, introduction of the microwave-heating distillation reduced the pre-treatment time to 3 min. and made rapid measurement possible.

The presently established method of tritium measurement significantly simplified the process and reduced the handling time without losing the quality of the data, and thus made it possible to handle a large number of samples within a short time. This would be a substantial improvement for the radioactivity control in nuclear

facilities and hot laboratories.

References to Chapter II

- [1] R. R. Jones, R. Southwood, "Radiation and Health", Central Foreign Books (Chuo Yosho, Publishers) Ltd., Tokyo (1987).
- [2] Richard B. Firestone, "Table of Isotopes" 8th Ed., Richard B. Firestone John, Wiley & Sons, Inc., New York (1996).
- [3] Science and Technology Agency "Radioactivity Measuring Method Series 9, Tritium Analysis Method", Japan Chemical Analysis Center, Chiba (1977).
- [4] H. Ishikawa, "The Latest Liquid Scintillation Measuring Method", Nanzando, Tokyo (1992).
- [5] R. D. Hiebert and R. J. Watts, *Nucleonics*, 11(12), 38 (1953).
- [6] Science and Technology Agency, "Radioactivity Measuring Method Series 9, Tritium Analysis Method", Japan Chemical Analysis Center Chiba (1977).
- [7] S. Yoshida, Y. Yamaguchi, J. Yamashita, Annual Report of Radioisotope Res. Center, Osaka Univ., 66 (1990).
- [8] S. Yoshida, Y. Yamaguchi, J. Yamashita, Annual Report of Radioisotope Res. Center, Osaka Univ., 56 (1991).
- [9] S. Yoshida, Y. Yamaguchi, J. Yamashita, Annual Report of Radioisotope Res. Center, Osaka Univ., 52 (1992).
- [10] S. Yoshida, Y. Yamaguchi, J. Yamashita, Annual Report of Radioisotope Res. Center, Osaka Univ., 39 (1993).
- [11] S. Yoshida, Y. Yamaguchi, J. Yamashita, Annual Report of Radioisotope Res. Center, Osaka Univ., 24 (1994).

- [12] S. Yoshida, Y. Yamaguchi, Annual Report of Radioisotope Res. Center, Osaka Univ., 18 (1995).
- [13] Y. Yamaguchi, S. Yoshida, A. Takahashi, T. Yamamoto, The 31st Annual Meeting on Japan Health Physics Society, Proceedings, 124 (1996).
- [14] T. Kaji, "Tritium Data Collection·1988", 393 (1988).
- [15] S. Mano, Y. Yamaguchi, B. Kyoh, T. Yamamoto, The 32nd Annual Meeting on J. Health Phys. Soc., Proceedings, 99 (1997).
- [16] Y. Yamaguchi, S. Mano, B. Kyoh, T. Yamamoto, J. J. Health Phys. Soc., submitted for publication
- [17] E. Abe, "Microwave", Tokyo Univ. Publication, Tokyo (1983).
- [18] V. Lopes-Avila, J. Benedicto, Trends in Anal. Chem., 15, 334 (1996).
- [19] K. Ganzler, A. Salgo, K. Volko, J. Chromatogr., 371, 299 (1986).
- [20] V. Lopez-Avila, J. Benedicto, C. Charan, R. Young, W. F. Beckert, Environ. Sci. and Technol., 29, 2709 (1995).
- [21] O. Donard, E. Lalere, F. Martin, R. Lobinski, Anal. Chem., 67, 4250 (1995).

Conclusion

In the present study, efforts were made to establish the standard irradiation field for uses of calibration of dosimeters and medical irradiation experiment, and to develop new method of environmental tritium measurement.

The main accomplishments of this thesis are summarized as follows:

1. As set of collimators incorporated with a mobile shield was designed so as to restrain the size of radiation field within the shielded area. Further, the automatic control of the radiation field size allowed installation of a strong irradiation system in an ordinary workroom without heavy radiation shield.
2. The dose rate and energy spectrum in the irradiation field were evaluated both by calculation and radiation measurement. The effect of the scattered radiation was investigated for various configurations of the shield and the detector for calibration with respect to the radiation source to find the optimum irradiation condition. It was concluded then that the best configuration would be the irradiation spot being the midpoint between the source and shield when they were placed apart by 2m.
3. The γ -ray irradiation system was applied to the calibration of monitors such as personnel dosimeters and survey meters, and to the low-dose irradiation of experiment animals. Construction of the high-precision standard radiation field enabled us to carry on regularly the detector calibration, so that the reliability of the radiation

control was greatly improved. Such standard irradiation facilities are very scarce among Japanese universities; they are limited to only Osaka University and Tohoku University. Especially, the one installed in Osaka University is noteworthy because of its high-precision irradiation field without much scattered radiation.

4. The reduced-pressure distillation system developed in the present study functions sufficiently as a pre-treatment device of the environmental tritium measuring samples. Introduction of such an inexpensive and simple system would encourage the environmental tritium measurement even for small hot laboratories.
5. A microwave-heating distillation system developed in the present study in order to cover the shortage of the above reduced-pressure distillation method in the pre-treatment of samples. The reduced-pressure distillation took several hours for the treatment of the sample. On the contrary, introduction of the microwave-heating distillation reduced the pre-treatment time to 3min. and thus made rapid measurement possible. The method made it possible to quickly handle many numbers of monitoring samples in case of an emergency. The method of microwave-heating distillation will make a great deal of contribution to radiation control and safety.

Thus, high-precision dose-rate determination by designing a gamma-ray standard field and establishment of the environmental tritium measurement, even at an extremely low level, by means of a new sample treatment method were achieved.

They will substantially promote the studies on environmental sample

treatment and low level radiation measurements.

Particularly, application of the microwave heating to the sample treatment enabled regulation of the sample temperature over a wide range above room temperature by delicately controlling the output level. This technique is applicable not only to science but also to engineering or medicine. For instance, quick extraction of a certain substance from biological or creature samples would be probable by this method. It will be utilized in practically all fields.

List of Publications

- [1] Y. Yamaguchi, J. Yamamoto, T. Nomura and J. Yamashita: "An Automatic Controlled Field Size of a γ -ray Irradiation System", *Radioisotopes*, **43**, 341-345 (1994).
- [2] Y. Yamaguchi, J. Yamamoto, T. Nomura, J. Yamashita and T. Yamamoto; "Estimation of the Scattered Radiation in the Calibration Field Generated by the Gamma-Ray Irradiation System", *J. Health Physics Society*, **31**, 343-347 (1996).
- [3] H. Nakajima, H. Ryo, Y. Yamaguchi, T. Saito, K. G. Yeliseeva and T. Nomura; "Radionuclides Carved on the Annual Rings of a Tree Near Chernobyl", *Health Physics*, **74**, 265-267 (1998).
- [4] Y. Yamaguchi, A. Matsumoto, K. Oda, B. Kyoh and T. Yamamoto; "Transmitting the Environmental Radiation Data Files on Internet", *J. Health Physics Society*, submitted for publication.
- [5] Y. Yamaguchi, S. Mano, B. Kyoh and T. Yamamoto; "Pre-treatment of Samples to Use for the Environmental Radiation Measurement by the Microwave", *J. Health Physics Society*, submitted for publication.

Acknowledgments

The works in this thesis have been performed under the direction of Professor Hiroshi Baba of Osaka University. The author wishes to express his sincere gratitude to Prof. H. Baba for his many valuable suggestions, stimulative discussions and kind encouragement, and also for his critical reading of this manuscript for refining this thesis.

The author wishes to express his sincere gratitude to Director Noriaki Takahashi and Professor Takayoshi Yamamoto of Radioisotope Research Center of Osaka University.

Also, the author is deeply indebted to Associate Professor Junji Yamamoto of Setsunan University for his continuous advice and impressive instructions.

Again, the author wishes to thank Tadashi Saito and all members of Radioisotope Research Center for their kind discussions and precious friendships.

Further, the author's gratitude is extended to Professor Emeritus Nobuhiko Kunitomi and Ex-Professor Jinpei Yamashita, for their encouragement.

Finally, the author thanks sincerely to his parents, his wife, all other family and his friends for their unfailing understanding and continuing encouragement to his works.

Handwritten text in a small box at the bottom right corner, possibly a library or archival label.